

POCKET BOOK OF HOSPITAL CARE FOR OBSTETRIC EMERGENCIES INCLUDING MAJOR TRAUMA AND NEONATAL RESUSCITATION

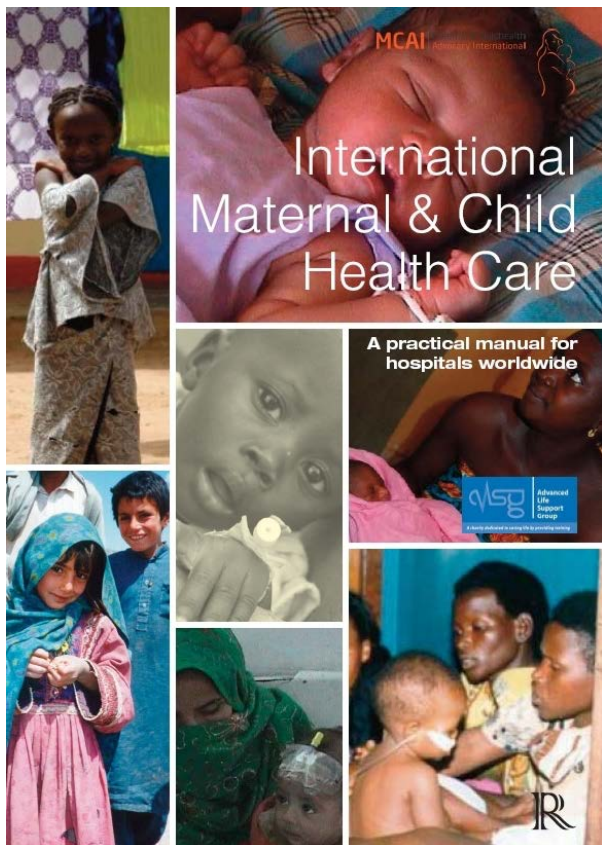

MCAI Maternal & Childhealth
Advocacy International



© 2014 Maternal & Childhealth Advocacy International (MCAI)

This pocketbook is a summary of the emergency components of obstetrics and resuscitation of the newborn infant from our textbook "*International Maternal & Childhealth Care. A practical manual for hospitals worldwide*". The reader is referred to the textbook when more details on the medical problem under consideration are required.

Editor: David Southall

Associate Editors: Alice Clack, Johan Creemers, Angela Gorman, Assad Hafeez, Brigid Hayden, Ejaz Khan, Grace Kodindo, Rhona MacDonald, Yawar Najam, Barbara Phillips, Diane Watson, Dave Woods, Ann Wright.

Every effort has been made to ensure that the information in this book is accurate. This does not diminish the requirement to exercise clinical judgement, and neither the publisher nor the authors can accept any responsibility for its use in practice.

All rights reserved. The whole of this work, including all text and illustrations, is protected by copyright. No part of it may be copied, altered, adapted or otherwise exploited in any way without express prior permission, unless in accordance with the provisions of the Copyright Designs and Patents Act 1988 or in order to photocopy or make duplicating masters of those pages so indicated, without alteration and including copyright notices, for the express purpose of instruction and examination. No parts of this work may otherwise be loaded, stored, manipulated, reproduced, or transmitted in any form or by any means, electronic or mechanical, including photocopying and recording, or by any information storage and retrieval system, without prior written permission from the publisher, on behalf of the copyright owner.

British Library Cataloguing in Publication Data

A catalogue record for the textbook is available from the British Library.

ISBN-13: 978 184619 992 9

Contents

SECTION	TITLE	PAGE NUMBERS
1	Triage	5-7
2	Infection control and handwashing	8
3	Fluid administration: oral and intravenous	9
4	Blood transfusion	9-11
5	Pain Management	12-18
6	Transport of ill patients	19
7	Structured approach to emergency care	20-32
8	Basic life support and cardiopulmonary resuscitation in pregnancy	33-40
9	Skills in an emergency	41-64
10	WHO safe childbirth checklist	65-69
11	Symptoms and signs of emergencies in pregnancy	70-80
12	Shock during pregnancy and after birth	81-86
13	Severe anaemia in pregnancy including sickle cell disease	87-89
14	Septic abortion or miscarriage	90-91
15	Major obstetric haemorrhage: Ruptured ectopic pregnancy Miscarriage Antepartum haemorrhage: APH Post partum haemorrhage: PPH	92-124 92-94 94-100 100-108 109-124
16	Hypertension, pre-eclampsia and eclampsia	125-140
17	Prolonged and obstructed labour Uterine rupture Shoulder dystocia	141-151 146-147 147-151
18	Severe infection after birth: puerperal	152-155

SECTION	TITLE	PAGE NUMBERS
	sepsis	
19	Pulmonary embolism	156-157
20	Amniotic fluid embolism	158
21	Reduced fetal movements and fetal death	159
22	Fetal distress during labour	160-161
23	Multiple births	162-165
24	Malpositions and malpresentations Occipito posterior Face Breech	166-180 172-174 175-176 177-180
25	Preterm pre-labour rupture of membranes and preterm labour	181-183
26	Prolapsed umbilical cord	184-186
27	Inverted uterus	187-190
28	Hyperemesis gravidarum	191-192
29	Heart failure	193-194
30	Severe asthma	195-196
31	Anaphylaxis	197-198
32	Diabetes and diabetic ketoacidosis	199-204
33	Reduced conscious level and coma	205-209
34	Pneumonia	210-211
35	Severe dehydration and gastroenteritis	212-216
36	Severe malaria	217-223
37	Appendicitis	225
38	Cystitis and pyelonephritis	226
39	Varicella zoster	227
40	Postnatal depressive illness	228-229

SECTION	TITLE	PAGE NUMBERS
41	Emergency obstetric procedures: Urethral catheter Ventouse (vacuum) delivery Forceps delivery Caesarean section Symphiotomy Destructive procedures Episiotomy Cervical tear repair Manual removal of placenta Pudendal nerve block	230-248 230 230-237 238-240 240-241 241-242 242-243 243-244 244-245 245-247 247-248
42	Major trauma in pregnancy Procedures: Surgical cricothyrotomy Cervical spine immobilization Needle thoracocentesis Chest drain Needle pericardiocentesis Abdominal paracentesis Log roll	249-277 253-254 254-255 257-258 258-259 270-271 272-273 274
43	Burns	277-284
44	Poisoning	285-289
45	Care of the newborn and neonatal resuscitation	290-305
46	Appendix	305-311
	Index	

Section 1 Triage for women who are or who may be pregnant: seeing the sickest first

Triage involves **determining the priority of a patient’s treatment based on the severity of their condition, not on when they arrived or their place in a queue.**

Triage divides patients into the following three categories:

1. those who are at imminent risk of death, and require immediate resuscitation
2. those who are seriously ill or injured, and who need timely emergency management
3. those who have conditions which can wait before further assessment and possible treatment.

Rapid initial assessment

When a woman is or might be pregnant presents to a health facility she is of immediate concern and should be given priority through triage without disadvantaging seriously affected men or older women. This process requires the ability to recognise first, those patients who need resuscitation (**immediate management, group 1, ‘red’**), and secondly, those who need **urgent treatment (group 2, ‘orange’)** (see Table 1.1). This process must take only a few seconds, as any delay can be fatal.

Table 1.1 A triage scale

<i>Triage number</i>	<i>Type of action</i>	<i>Colour</i>	<i>Maximum target time to action (minutes)</i>
Category 1	Immediate	Red	0
Category 2	Urgent	Orange	15
Category 3	Non-urgent	Green	60 (1 hour)

From the moment of arrival at the health facility (some information may be given before arrival, by contact between the ambulance crew and the facility), a decision on those who need resuscitation must be made. The decision making is based on the clinical signs listed in the second column of Table 1.2.

Once a triage category has been identified, the patient should have observations of respiration rate and characteristics (e.g. wheeze, stridor, recession), pulse rate/volume, blood pressure, temperature and a rapid measure of conscious level, such as AVPU score (Alert, responds to Voice, responds to Pain, Unconscious; see Section 7), measured and recorded.

Table 1.2 Clinical signs on simple observation or from history which indicate the need for immediate resuscitation in pregnancy

<i>Underlying mechanism</i>	<i>What does the healthcare worker undertaking triage see in the patient or hear from the relatives?</i>
A problem that is obstructing, or might obstruct, the upper airway A: AIRWAY	The patient is unconscious The patient is fitting or has been fitting There is major trauma to the face or head, including burns There is severe stridor or gurgling in the throat
Any problem producing apnoea, severe respiratory distress or cyanosis B: BREATHING	The patient is not breathing The patient is gasping The patient is cyanosed The patient is having so much difficulty breathing that they cannot speak

Section 1:Triage

<i>Underlying mechanism</i>	<i>What does the healthcare worker undertaking triage see in the patient or hear from the relatives?</i>
Any problem producing cardiac arrest, shock or heart failure C: CIRCULATION	The patient has heavy vaginal bleeding The patient has suffered major trauma The patient appears shocked (very pale/white, cannot sit up, has a reduced conscious level)

Table 1.3 Clinical signs on simple observation or from the history in pregnancy which indicate the need for urgent management but not resuscitation

<i>Underlying mechanism</i>	<i>What does the healthcare worker undertaking triage see or hear from the patient or the relatives?</i>
A problem that might obstruct the upper airway in the future A: AIRWAY	There is trauma to the face or head, or burns to this area, but the patient is conscious and able to speak Ingestion or accidental overdose of drugs that may alter the conscious level?
A problem producing respiratory difficulty B: BREATHING	The patient has difficulty breathing but can speak, and there is no cyanosis
Any problem that might, unless rapidly treated, lead to shock or heart failure C: CIRCULATION	The patient has vaginal bleeding which is heavy*, but is not yet shocked (they are able to stand or sit up and speak normally) The patient has suffered major trauma and is not yet shocked, but may have internal bleeding (they are able to stand or sit up and speak normally) Any burns covering more than 10% of the body The patient has fainted and has abdominal pain (this includes possible ruptured ectopic pregnancy) but they are now able to stand or sit up and speak normally The patient has passed products of conception and is still bleeding, but is not shocked (they are able to stand or sit up and speak normally) The patient has severe abdominal pain, but is not shocked (they are able to stand or sit up and speak normally) The patient is extremely pale, but is not shocked (severe anaemia) (they are able to stand or sit up and speak normally)
Possible severe pre-eclampsia and impending eclampsia	The patient is complaining of a headache and/or visual disturbance
Severe dehydration	The patient is complaining of severe diarrhoea/vomiting and is feeling very weak, but is not shocked (they are able to stand or sit up and speak normally)
Possible complication of pregnancy	The patient has abdominal pain not due to uterine contractions of normal labour
Possible premature labour	The patient is not yet due to deliver, but has had ruptured membranes (with or without contractions)
Infection that might become dangerous	The patient has a high fever > 38°C (they are hot to touch or shivering, but are able to stand or sit up and speak normally)

Section 1:Triage

<i>Underlying mechanism</i>	<i>What does the healthcare worker undertaking triage see or hear from the patient or the relatives?</i>
Possible intrauterine death	After 24 weeks of pregnancy the patient has not felt fetal movements for 24 hours or more
Prolapsed cord	The patient says that her membranes have ruptured and she can feel the umbilical cord

*Heavy bleeding is defined as a clean pad or cloth becoming soaked within less than 5 minutes.

Note that a low blood pressure in pregnancy is a late and dangerous sign.

Special priority signs

Haemorrhage

Category 1 patients (red) are those who are exsanguinating.

A haemorrhage that is not rapidly controlled by the application of sustained direct pressure, and which continues to bleed heavily or soak through large dressings quickly, should also be treated **immediately (Category 1, red)**.

Conscious level

Category 1 or immediate priority (red) includes all unconscious patients (U or P on the AVPU scale).

In patients with a history of unconsciousness or fitting, further dangerous events are possible. Those who respond to voice are categorised as **Category 2 urgent (orange)**.

Pain

Patients with severe pain should be allocated to **Category 1 immediate (red)**, and those with any lesser degree of pain should be allocated to **Category 2 urgent (orange)**.

For patients who have sustained **significant trauma or other surgical problems**, anaesthetic and surgical help is required **urgently**.

If there is an **urgent referral** from another healthcare facility or organisation, the patient must be seen **immediately** or **urgently**, depending on the circumstances.

Importance of regular reassessment

Triage categories may change as the patient deteriorates or gets better. To achieve this, all clinicians involved in the pathway of care should rapidly assess priority whenever they encounter the patient. Changes in priority must be noted, and the appropriate actions taken.

All patients with symptoms or signs in the **immediate (red)** or **urgent (orange)** categories represent emergencies or potential emergencies, and need to undergo the structured approach to emergencies as outlined in Section...

Non-urgent cases

Proceed with assessment and further treatment according to the patient's needs once the immediate and urgent patients have been stabilised.

SECTION 2 Infection control

Requirements and procedures

- *A clean and adequate water supply*
- Accessible sinks in all areas
- Effective cleaning policies
- *Effective services for disposal of human and other waste*
- Laundry service
- Strict hand-washing policies
- *Disposal of body fluids*
- *Cleaning, disinfection and sterilisation of equipment and furniture*

Figure 2.1 Handwashing techniques

Repeat each movement 5 times

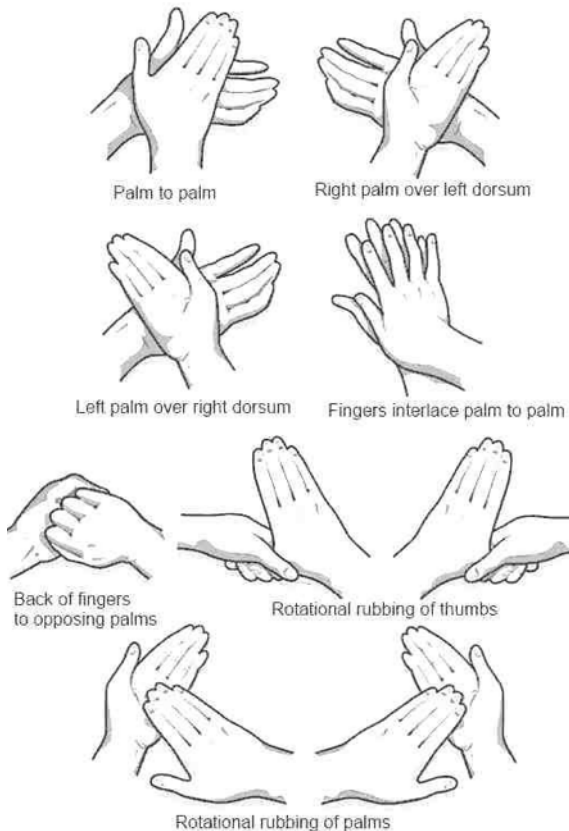

SECTION 3: Fluid administration

Fluid replacement

Oral rehydration solutions – used in gastro-enteritis to maintain electrolyte balance. Prepare by adding **1 sachet to 7 oz (210 ml)** clean water. **One ounce = 30ml**

IV fluids must only be used when essential and enteral feeds not available or absorbed.

Always check before use: seal is not broken, expiry date, solution is clear and free of visible particles

Dextrose/glucose solutions unless in Ringer-Lactate or Hartmann's or 0.9% saline are not appropriate for replacing fluid losses Never infuse plain water IV: causes haemolysis and will be fatal

Maintenance requirement of electrolytes:

Sodium (Na⁺) **150mmol/24hour in pregnancy**

Potassium (K⁺) **100 mmol/24hour in pregnancy**

Crystalloids (Ringer-Lactate or Hartmann's) when infused IV only ¼ remains inside the vascular compartment, the rest passes into the extra-cellular space.

All fluids should be prepared and given using an aseptic technique.

It is important to observe cannula site (directly by removing dressing) for redness and swelling before each IV injection. Observe patient for pain or discomfort at drip site. If any signs of inflammation, stop fluids, reassess need for continuing IV fluid drugs and resite cannula.

Record all fluid intake on a fluid balance chart.

Fluids can be calculated in drops/minute as follows: (standard giving sets with a drop factor of 20 drops = 1mL then ml/hour divided by 3 = drops/minute.

Flush cannula with 0.9% saline or Ringer-Lactate or Hartmann's 4-hourly if continuous fluids are not being given

Section 4: Blood transfusion

Ensure blood is compatible with the recipient, is infection free, is given safely and only when essential.

WHO defines anaemia as any Hb below 11G/dl but in pregnancy haemodilution means that a figure of <10G/dl is more appropriate.

In a pregnant woman, transfusion may be considered at a Hb level of 6 – 7 G/dL taking into account other factors.

Factors other than the Hb level that must be taken into account when considering transfusion:

- What is the heart rate? If rapid this will favour the decision to transfuse
- What is the respiration rate? If rapid this will favour the decision to transfuse
- Is the patient already in circulatory collapse (shock)? **Transfusion is very urgent**
Some patients will not show any of these features, and it might then be justifiable to delay transfusion and use haematinics – iron and folic acid. Some patients may show the above

Section 3 and 4: Fluids and blood transfusion

features and have a Hb of more than 6G/dL. It will also be necessary to transfuse such patients.

In pregnancy blood volume is 100ml/Kg of blood.

During initial transfusion in pregnancy give 1-2 units (each 500 ml) with frusemide 40mg IV after each 500ml.

Each 500 mL transfusion should ideally take 4 hours except in cases of shock when blood must be given as quickly as possible. Each unit of blood transfused should never take longer than 6 hours. Blood left out of the fridge longer than 6 hours should be discarded.

A trained person must monitor the patient as frequently as possible during a transfusion (T, P, R, BP, urine output)

Blood should be warm before it is infused. This can be achieved by passing the coiled delivery tube through a bowl of lukewarm water by the patient's side or by warming the transfusion pack under a relative's clothes.

For usual blood giving set there are 20 drops per ml; in changing ml per hour into drops per minute you divide by 3. Eg a pregnant woman requiring 500mL in 4 hours = 125 mL per hour: 125 mL per hour divided by 3 = 42 drops per minute

A safe way of giving blood when there is a danger of fluid overload is by using an IV giving set with an in-line burette.

Blood Groups

There are 4 major blood groups - A, B, AB and O. To avoid ABO incompatibility, the blood group of the donor and the receiver must be known. Blood can only be donated in the direction of the arrows:

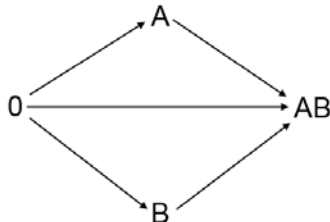

Donors with blood group O can donate to patients with blood group A, B, AB or O

Donors with blood group A can donate to patients with blood group A or AB

Donors with blood group B can donate to patients with blood group B or AB

Donors with blood group AB can donate only to patients with blood group AB

Rhesus negative donors can give to rhesus +ve and -ve patients

Rhesus positive donors can only give to rhesus +ve patients

Blood group O negative is the universal donor. If blood group is unknown or uncertain and blood is required before a cross-match can be performed, give O Rhesus negative blood, if available.

Blood Transfusion Reactions

Investigations and management

- Where a serious acute transfusion reaction is suspected, **stop the transfusion** and take down the donor blood bag **plus giving set** and send back to the lab with notification of event.

Section 3 and 4: Fluids and blood transfusion

- To detect a haemolytic reaction, send post-transfusion blood sample (for FBC and clotting, repeat type and crossmatch, antibody screen and direct Coombs' test) and urine specimen (for detection of urinary haemoglobinuria: if available) from the transfusion recipient.
- Where bacterial contamination is suspected, send blood cultures from patient and remains of blood in the bag.
- If the patient is dyspnoeic, check for fluid overload and pulmonary oedema.

Management

Where the only sign is a rise in temperature of $<1.5^{\circ}\text{C}$ from baseline or urticaria, recheck that the correct blood is being transfused, give paracetamol and antihistamine, reset the transfusion at a slower rate and observe more frequently.

Whilst fever or rigors are not uncommon in response to a transfusion and may represent a non-haemolytic febrile reaction, they may also be the first sign of a severe adverse reaction.

Where the reaction is more severe:

- Stop the transfusion and call a doctor urgently to review the patient.
- Vital signs (temp, BP, pulse, respiratory rate, O_2 saturation levels) and respiratory status (dyspnoea, tachypnoea, wheeze and cyanosis) should be checked and recorded. Look for heart failure (basal lung crepitations, enlarged liver)
- Check the patient's identity and recheck against details on blood bag and compatibility label or tag.

Initial management where ABO incompatibility is suspected is to:

- Take down blood bag AND giving set with blood in it
- Keep the intravenous (IV) line open with 0.9% saline or Ringer-Lactate or Hartmann's.
- Give oxygen and fluid support as appropriate.
- Monitor urine output, usually following catheterisation. Maintain urine output at more than 100 ml/hour, giving furosemide if this falls.
- Consider inotrope support if shocked and not responding to IV fluids.
- Treat DIC by giving fresh new blood fully matched to recipient
- Inform the hospital transfusion department immediately.

Where another haemolytic reaction or bacterial infection of blood unit is suspected:

- Send haematological and microbiological investigations as outlined above.
- General supportive management is as for ABO incompatibility.
- Start broad-spectrum IV antibiotics if bacterial infection is considered likely.

Where anaphylaxis or severe allergic reaction is suspected:

- Follow anaphylaxis protocols (see Section 31).

Where Transfusion Related Acute Lung Injury TRALI is suspected:

- Give high-concentration oxygen, IV fluids and inotropes (as for acute respiratory distress syndrome).
- Ventilation may be urgently required - discuss with anaesthetist.
- TRALI improves over two to four days in over 80% cases with adequate management and respiratory support.

Where fluid overload is suspected:

- Sit the patient up
- Give furosemide 40 mg IV and high-concentration of oxygen.

Section 5: Pain control in pregnancy

Local anaesthetic drugs by infiltration (the most widely used method)

Lidocaine 0.5–2%

- Used for rapid and intense sensory nerve block.
- Onset of action is within 2 minutes; the procedure must not be started until an anaesthetic effect is evident.
- Effective for up to 2 hours.

Doses:

A maximum of 200 mg (500 mg if used with adrenaline) not more than 4-hourly

Preparation of lidocaine 0.5% solution. Combine:

- lidocaine 1%, 1 part
- Ringer-lactate, Hartmann's solution, 0.9% saline or sterile distilled water, 1 part

Advantages of adding adrenaline include:

- less blood loss
- longer effect of anaesthetic (usually 1–2 hours)
- lower risk of toxicity because of slower absorption into the general circulation.

The concentration of adrenaline to use is 1:200 000 (5 micrograms/mL). *Note:* It is critical to measure adrenaline carefully and accurately using a 1-mL or, at the most, 2-mL syringe. Observe strict infection prevention practices.

Table 5.1 Formulas for preparing 0.5% lidocaine solutions containing 1:200 000 adrenaline

<i>Desired amount of local anaesthetic needed (mL)</i>	<i>Ringer-lactate or Hartmann's solution (mL)</i>	<i>Lidocaine 1% (mL)</i>	<i>Adrenaline 1:1000 (mL)</i>
20	10	10	0.1
40	20	20	0.2
100	50	50	0.5
200	100	100	1.0

Local infiltration into an abscess is not recommended, because local anaesthetics are ineffective in inflamed tissues.

Complications of local anaesthesia

- If more than 40 mL of 0.5% lidocaine are to be used, add adrenaline as described above. Procedures that may require more than 40 mL of 0.5% lidocaine are Caesarean section and repair of extensive perineal tears.
- Use the lowest effective dose.
- Inject slowly.
- Avoid accidental injection into a vessel. There are three ways of doing this:
 1. the moving needle technique (preferred for tissue infiltration): the needle is constantly in motion while injecting, which makes it impossible for a substantial amount of solution to enter a vessel
 2. the plunger withdrawal technique (preferred when considerable amounts are injected into one site): the syringe plunger is withdrawn before injecting, and if blood appears the needle is repositioned and another attempt is made
 3. the syringe withdrawal technique: the needle is inserted and the anaesthetic is injected as the syringe is being withdrawn.

Section 5: Pain control in pregnancy

Symptoms and signs of lidocaine allergy

Redness of skin, skin rash/hives, bronchospasm, vomiting, serum sickness and rarely shock.

Symptoms and signs of lidocaine toxicity

Note: lidocaine can be absorbed through mucous membranes in a large enough dose to be toxic.

Table 5.2 Lidocaine toxicity

<i>Mild toxicity</i>	<i>Severe toxicity</i>	<i>Life-threatening toxicity (rare)</i>
Numbness of lips and tongue	Sleepiness	Tonic–clonic convulsions
Metallic taste in mouth	Disorientation	Respiratory depression or arrest
Dizziness/lightheadedness	Muscle twitching and shivering	Cardiac depression or arrest
Ringling in ears	Slurred speech	
Difficulty in focusing eyes		

- Direct intra-arterial or IV injection of even a small amount may result in cardiac arrhythmias and convulsions (see above).
- Resuscitative facilities and healthcare professionals with resuscitative skills should be present.

If symptoms and signs of mild toxicity are observed wait a few minutes to see if the symptoms subside. Check vital signs and talk to the patient. Delay the procedure for at least 4 hours if possible.

Adrenaline toxicity

This is caused by excessive amounts or inadvertent IV administration, and results in:

- restlessness
- sweating
- hypertension
- cerebral haemorrhage
- rapid heart rate
- cardiac arrest.

Systemic drug treatment for pain

Figure 5.1 WHO two step ladder for pain control

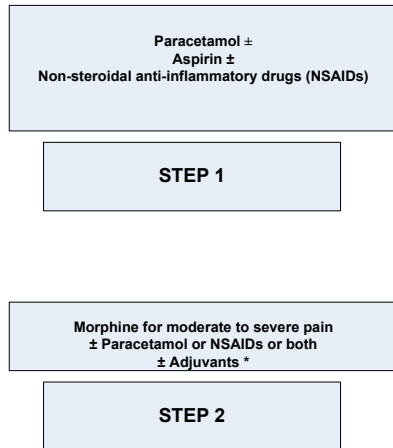

*An adjuvant is another drug (e.g. steroid or anxiolytic) or type of treatment (e.g. TENS or radiotherapy) that can prevent and relieve pain.

Non-opiate analgesics

Paracetamol

- This is the most widely used analgesic (and is anti-pyretic).
- It does not cause respiratory depression.
- It is dangerous in overdose but a safe and effective drug in recommended doses.
- It is given by mouth, rectally or intravenously.
 - The maximum daily dose should not be given for more than 3 days.
 - Caution is needed in patients with liver impairment.
 - There are no anti-inflammatory effects.
 - Paracetamol can be combined with NSAIDs and both have a morphine-sparing effect, lowering the dose, and therefore severity of side effects of morphine.

Non-steroidal anti-inflammatory drugs (NSAIDs) (e.g. ibuprofen, diclofenac)

Do not give NSAIDs in the third trimester of pregnancy, as they may close the ductus arteriosus and predispose to pulmonary hypertension of the newborn. They may also delay the onset and progress of labour.

- Anti-inflammatory, anti-pyretic drugs with moderate analgesic properties.
- Less well tolerated than paracetamol, causing gastric irritation, platelet disorders and bronchospasm.
- Do not give in patients with gastric ulceration, platelet abnormalities or significant asthma.
- Useful for post-traumatic and bone pain because of their anti-inflammatory effect. They are given by the oral or rectal route (e.g. diclofenac). There is a risk of gastric haemorrhage through whichever route the NSAIDs are given.

Section 5: Pain control in pregnancy

Opiate analgesics: Morphine

- The most important drug in the world for pain control, and WHO recommends that it should be universally available.
- In resource-limited countries it is mostly administered orally, which is useful for chronic or anticipated pain but less effective for acute pain. The latter requires IV administration of morphine.
- At an appropriate dose, analgesia occurs without impaired consciousness.
- Nausea and vomiting are rare with oral treatment, but when morphine is given intravenously for the first time it may produce this side effect.

Intravenous use of morphine

- Minimal haemodynamic effects in a supine patient with normal circulating blood volume.
- In hypovolaemic patients it can contribute to hypotension. Therefore:
 - monitor the patient's cardiovascular status
 - have an IV fluid bolus of Ringer-lactate or Hartmann's solution ready (500 mL to 1 litre in pregnancy).
- In excessive dosage it can produce a dose-dependent depression of ventilation and decreased respiratory rate, leading to apnoea.
- Patients who are receiving morphine in hospital (where it is often administered IV) need observation and/or monitoring of respiratory rate and sedation level.
- Morphine is better controlled by the IV than the IM route. If using the IV route, give a small dose initially and repeat every 3–5 minutes until the patient is comfortable. Individuals vary widely with regard to the dose needed to provide pain relief. It is rarely appropriate to give morphine intramuscularly, and for patients who are in shock, giving morphine IM is dangerous, as it can be initially poorly absorbed, and then quickly absorbed when perfusion improves, potentially leading to too high a blood level of the drug.
- Intravenous morphine can be dangerous in situations of raised intracranial pressure without the means to provide respiratory support.
- During late pregnancy or delivery, morphine can cause respiratory depression in the neonate.

Naloxone

Naloxone is an opiate antagonist that reverses the sedative, respiratory-depressive and analgesic effects of morphine, and so should be given to treat morphine overdose.

Table 5.3 Orally administered drugs for mild or moderate pain

Medicine	Maximum daily dose	In pregnancy	After birth of the baby
Paracetamol	4 doses in 24 hours	500 mg to 1 g 6-hourly	500 mg to 1 g 6-hourly
Ibuprofen		Do not use in pregnancy	400 mg orally 6 to 8 hourly Do not use in pre-eclampsia
Diclofenac		Do not use in pregnancy	100mg rectally 12 hourly Do not use in pre-eclampsia

Section 5: Pain control in pregnancy

Preparations:

Paracetamol: oral suspension, 120 mg/5 mL, 250 mg/5 mL; tablets, 500 mg.

Ibuprofen: oral suspension, 100 mg/5 mL; tablets, 200 mg, 400 mg.

Diclofenac: tablets, 25 mg, 50 mg; dispersible tablets, 10 mg.

Notes on ibuprofen and diclofenac

- Do not use in pregnancy. Can be used post delivery or Caesarean section unless the patient has pre-eclampsia
 - Caution is needed in patients with asthma, liver or renal failure.
 - Contraindications include dehydration, shock, bleeding disorders and hypersensitivity to aspirin.
 - NSAIDs and paracetamol can be used in combination.
- If rectal drugs are available, the doses are similar to oral doses.

Table 5.4 Intravenous paracetamol for mild or moderate pain

Age/weight	Dose	Maximum dose in 24 hours
Pregnant woman less than 50 kg body weight	15 mg/kg every 4–6 hours	60 mg/kg
Pregnant woman more than 50 kg body weight	1 g every 4–6 hours	4 g

Intravenous paracetamol

- Paracetamol IV is formulated as a 10 mg/mL aqueous solution (in ready-to-use 50-mL and 100-mL vials for infusion over 15 minutes).
- It is useful, effective and safe.
- The peak analgesic effect occurs within 1 hour, lasting approximately 4–6 hours.
- Ensure correct dose is given, as serious liver toxicity can occur in overdose.
- Side effects are rare but include rashes, blood disorders and hypotension on infusion.
- Caution is needed in patients with severe renal impairment, severe malnutrition or dehydration.
- Paracetamol helps to reduce the amount of morphine required when used in combination.

Table 5.5 WHO advice: oral and rectal morphine for severe pain in hospital

Age	Dose	Interval
In pregnancy	5–10 mg	Every 4 hours

Note: We suggest starting with the lower dose (5mg) and give more frequently, e.g. every hour if needed, until the patient is comfortable, then increase the new individual dose 4 hourly of morphine.

Almost all patients with chronic pain can be managed with oral morphine when this is given in the doses shown in Tables 5.5 and 5.6 in combination with non-opioid analgesics.

These are starting doses and can be increased as necessary on an individual patient basis if pain is not controlled.

Section 5: Pain control in pregnancy

Parenteral (IV) morphine

IV morphine is only needed if oral or rectal preparations are not going to be absorbed (e.g. in shock) or where rapid emergency onset is needed. IV morphine is potentially less safe, especially if staff shortages mean that the correctly calculated dose is not given.

Table 5.6 Intermittent IV (bolus) morphine dosage. We suggest that the total dose recommended is drawn up in 10mls 0.9% saline and that 2ml boluses of this solution are given every 3--5 minutes until the patient is comfortable. Also, if pain returns despite regular paracetamol/non-steroidal analgesia, further dose of oral/IV morphine can be given within 6 hours if the respiratory rate is normal and the patient is not sedated.

Age	Dose	Interval
In pregnancy	10 mg	Every 4 hours

Monitoring during morphine administration:

Side effects occur only in overdose and should not be seen at the doses stated here. They include the following:

1. Respiratory depression. If the respiratory rate is < 12 breaths/minute in pregnancy
 - Alert medical staff and ensure that bag/valve/mask and naloxone are available.
 - Monitor SaO₂ as appropriate (it should be higher than 94% in air).
2. Constipation. Use prophylactic laxatives.
3. Monitor for urinary retention.
4. Patients with liver and renal impairment may need lower doses and longer time intervals between doses. Caution in patients with head injuries

When treating overdose, always ventilate with bag/valve/mask first if patient is unresponsive before giving naloxone. This is because arrhythmias and pulmonary oedema can be caused if naloxone is given to a patient with high blood carbon dioxide concentrations.

Naloxone doses to reverse opioid induced respiratory depression

In pregnancy give 1.5 to 3 microgram/kg

If respiratory rate is low, but the patient's oxygen saturation is acceptable (>94%) with facemask oxygen, in order to avoid complete reversal of analgesia draw up 400 microgram naloxone into 20ml and give 1-2mls every 2 minutes until the patient is rousable and the respiratory rate increased to an appropriate rate.

Preparations: Ampoule 20 microgram/mL

Give IV or IM if IV is not possible. Repeat after 2--3 minutes if there is no response; the second dose may need to be much higher (up to 100 micrograms/kg). An IV infusion may be needed if protracted or recurrent depression of respiration occurs because naloxone is short acting compared with most opioids.

Starting dose for naloxone infusion: 5 to 20microgram/kg/hour

(For the newborn, to treat respiratory depression due to maternal opioid administration during labour or delivery 200 microgram as a single IM dose or 60 microgram/kg)

Prevention and treatment of nausea and vomiting due to initial dose of morphine

1. Cyclizine. This covers the widest range of causes of nausea and vomiting with the least side effects. The IV dose in pregnancy 50mg 8 hourly
2. Domperidone - where gastric emptying a problem, then as in Table 5.7 for doses

Table 5.7 Domperidone for prevention and treatment of nausea and vomiting

Section 5: Pain control in pregnancy

<i>Domperidone</i>	
<i>Oral</i>	<i>Rectal</i>
In pregnancy: 10–20 mg 3–4 times daily, up to a maximum of 80 mg daily Tablets, 10 mg; Suspension, 5 mg/5 mL	In pregnancy, 60 mg twice daily Suppositories, 30 mg

Both of the above anti-emetics can cause extrapyramidal side effects, including acute dystonia, which can be treated with diazepam IV in pregnancy, 5 to 10 mg.

Sedation Sedation is not recommended for use in pregnancy after the first trimester, because of the risks of regurgitation and aspiration. A health worker skilled in anaesthesia must be present when sedation is being used in pregnancy.

Section 6: Transport of patients

Section 6: Transport of pregnant women with complications

All resuscitation, emergency treatment and stabilisation must be performed before moving the patient. The basic principles of transport are ongoing ABCD

TABLE 6.1 Transport checklist

Airway/Breathing		Yes/No
Is the airway safe?	Is there anything that can be done to improve the airway?	Yes/No
Is oxygen required?	Pulse oximeter (battery operated with additional power from the ambulance cigarette lighter) can help to guide the need for oxygen	Yes/No
Is oxygen available?	Oxygen cylinders full and working – enough for the return expected journey	Yes/No
Is ventilatory support required?	Bag-valve-mask of the correct size available and working	Yes/No
Suction	Manual system and catheters available	Yes/No
Circulation		Yes/No
IV access	Working and secured	Yes/No
Volume	Ringer-lactate or Hartmann's solution bags and delivery kits	Yes/No
D Neurology		Yes/No
Temperature	Sufficient blankets available	Yes/No
Blood sugar level	Glucose for IV or gastric tube administration available	Yes/No
Other		Yes/No
Birth needs	Delivery kit, bag-valve-mask for neonate, towels, oxytocin, misoprostol, magnesium sulphate and condom catheter	
Documentation	All relevant documentation with the patient	Yes/No
Family members	Family members know what the plan is	Yes/No
Healthcare communication	Receiving site is aware of the patient and their expected time of arrival	Yes/No

Section 7: Structured approach to managing emergencies in pregnancy

Initial management

Stay calm.

Do not leave the patient unattended.

- Have a team leader in charge to avoid confusion.
- **Shout for help.** Ask one person to go for help and another to get emergency equipment and supplies (e.g. oxygen cylinder and emergency kit). Ideally resuscitation equipment and drugs should be available on one dedicated trolley.
- Assess and resuscitate in sequence using the structured approach – AcBCD: **Airway and haemorrhage control, Breathing, Circulation, Disability (Neurological Status)** (see below).
- If the patient is conscious, ask what happened and what symptoms they have.
- **Constantly reassess the patient**, particularly after any intervention.

Structured approach to any pregnant woman presenting as an emergency

Approach emergencies using the structured AcBCD (Airway and haemorrhage control, Breathing, Circulation, Disability) approach, which ensures that all patients with a life-threatening or potentially life-threatening problem are identified and managed in an effective and efficient way **whatever their diagnosis or pathology.**

Primary assessment and resuscitation are concerned with the maintenance of vital functions and the administration of life-saving treatments, whereas secondary assessment and emergency treatment allow more specific urgent therapies to be started.

Secondary assessment and emergency care require a system-by-system approach in order to minimise the risk of significant conditions being missed.

Following cardiac and/or respiratory arrest, the outcome for pregnant women is poor. Earlier recognition and management of potential respiratory, circulatory or central neurological failure which may progress rapidly to cardiac and/or respiratory arrest will reduce mortality..

Primary assessment and resuscitation involves sequential assessment and resuscitation of vital functions – **Airway and haemorrhage control, Breathing and Circulation.**

If there are no life-threatening signs, the primary assessment can be completed within about 1 minute. If life-threatening signs are identified, resuscitation procedures are required.

If you are working on your own and have been unable to summon help, you must resuscitate Airway before Breathing, and Breathing before Circulation. This is because oxygen cannot be carried around in the blood to the vital organs if the blood is not oxygenated first, and the lungs cannot oxygenate the blood if there is no airway to allow air containing oxygen to enter the lungs. **Similarly if there is haemorrhage, it is vital that this is stopped at the same time as ensuring the airway is open.**

If assistance is available, one person can deal with Airway, another with haemorrhage control, another with Breathing and a third with Circulation, all working simultaneously, but there should be a 'team leader' to take overall control.

During resuscitation, interventions that are either life-saving or designed to prevent the patient reaching a "near-death" situation are performed (see below). These include such procedures as basic airway opening procedures, procedures to stop haemorrhage (if possible), suction, oropharyngeal airway insertion, intubation, assisted ventilation, venous cannulation and IV fluid

Section 7: Structured approach to managing emergencies

resuscitation (when safe and appropriate). At the same time, oxygen is provided to all patients with life-threatening Airway, Breathing or Circulatory problems, vital signs are recorded, and essential monitoring is established.

This sequential primary assessment and any necessary resuscitation occur **before** any illness-specific diagnostic assessment or treatment takes place. Once the patient's vital functions are working safely, secondary assessment and emergency treatment can begin.

After each intervention, its effects should be tested by reassessment. **Regular reassessments** are a key component of the structured approach.

During **secondary assessment**, illness-specific pathophysiology is sought and emergency treatments are instituted. Before embarking on this phase, it is important that the resuscitative measures are fully under way. During the secondary assessment, vital signs should be checked frequently to detect any change in the patient's condition. If there is deterioration, primary assessment and resuscitation should be repeated in the "Airway + haemorrhage control, Breathing, Circulation" sequence.

Primary assessment and resuscitation

Assessment and resuscitation occur at the same time. The order of assessment and resuscitation enables identification of immediately life-threatening problems, which are treated as they are found.

A rapid examination of vital ABC functions is required. If at any stage a life-threatening A, B, or C problem is identified:

CALL FOR HELP

Primary assessment and resuscitation of airway and haemorrhage control

The first priority is establishment or maintenance of airway opening.

If the patient has major trauma or obstetric haemorrhage and is obviously bleeding rapidly, measures to stop exsanguination must be instituted at the same time as Airway resuscitation.

Primary assessment and resuscitation of airway

LOOK- for chest or abdominal movement

LISTEN – for breath sounds

FEEL – for breath

Talk to the patient. A patient who can speak or cry has a clear airway.

Signs associated with airway obstruction may include any of the following:

- an absence of breathing
- stridor, snoring, or gurgling in the throat
- cyanosis
- chest wall recession
- agitation, reduced consciousness, or coma.

Airway obstruction is most commonly due to obstruction by the tongue in an unconscious patient.

Resuscitation

Open the airway and keep it open

If there is no evidence of air movement, open the airway using the following:

Section 7: Structured approach to managing emergencies

- a head tilt, chin lift or jaw thrust manoeuvre (see Section 8 on basic life support). If this opens the airway and breathing starts, keep the airway open manually until it can be secured. Be careful when using head tilt if the cervical spine is at risk, but **opening the airway is always the priority**
- suction/removal of blood, vomit or a foreign body under direct vision.
If there is no improvement after adjusting the airway manually and trying different techniques, place an **oropharyngeal airway**, which may be helpful **if the patient is unconscious and has no gag reflex**. Avoid using a nasopharyngeal airway if there is any suspicion of base of skull injury. Place in the recovery position if unconscious.

If the airway is still obstructed, a definitive airway by intubation or surgical airway may be needed.

Give oxygen to all patients.

Reassess the airway after any airway-opening manoeuvres. If there continues to be no evidence of air movement, then airway patency can be assessed by performing an airway-opening manoeuvre while giving rescue breaths.

Advanced airway management

Advanced airway management techniques for securing the airway by **intubation** may be required in patients with any of the following:

- persistent airway obstruction
- altered level of consciousness, with failure to protect the airway, especially from vomiting and aspiration
- facial trauma, including burns, penetrating neck trauma with expanding haematoma, and severe head injury.

This should be performed by skilled professionals such as an anaesthetist.

If it is not possible to provide an airway using intubation, a **surgical airway** may be required (Section 42).

Specific resuscitation measures when there is an airway problem.

For upper airway obstruction due to **anaphylaxis**, nebulised adrenaline (5 mL of 1 in 1000) and IM adrenaline (1 mg IM in pregnancy).

If major trauma is present, throughout the primary assessment and resuscitation, protect the cervical spine with a collar, sand bags and tape if the patient is likely to have an unstable cervical spine and if subsequent surgical stabilisation is possible.

Primary assessment and resuscitation of breathing

An open airway does not guarantee adequate ventilation. The latter requires an intact respiratory centre and adequate pulmonary function augmented by coordinated movement of the diaphragm and chest wall.

Primary assessment

Assess whether breathing is adequate by:

- assessing **effort**:
 - recession
 - rate
 - added noises
 - accessory muscles
 - alar flaring
- assessing **efficacy**:
 - listening for reduced or absent **breath sounds**, or any wheezing, with a stethoscope or ear on chest wall
 - **chest and/or abdominal expansion** (symmetrical or asymmetrical)

Section 7: Structured approach to managing emergencies

- abdominal excursion
- SaO₂ if available
- assessing effects on **heart rate**
- assessing effects on **skin colour** (check the possibility of cyanosis)
- assessing effects on **mental status**.

Evidence of life-threatening respiratory difficulty

This includes the following:

1. absence of breathing (apnoea)
2. very high or very low respiratory rates
3. gasping, which is a sign of severe hypoxaemia, and may indicate impending respiratory arrest and death
4. severe chest wall recession, usually with increased respiratory rate, but pre-terminally with a fall in rate
5. severe hypoxaemia (cyanosis)
6. signs of tension pneumothorax (respiratory distress with hyper-resonant percussion) (see Section 42)
7. major trauma to the chest (e.g. tension pneumothorax, haemothorax, flail chest) (see Section 42)
8. signs of severe asthma (severe respiratory distress with wheezing, but a silent chest in severe asthma can be a near-fatal situation) (see Section 30).

Evidence of respiratory difficulty which can progress if not treated include:

- 1 increased respiratory rate
- 2 inspiratory stridor
- 3 reduced or absent breath sounds on auscultation
- 4 expiratory wheezing
- 5 chest expansion (most important), and reduced abdominal excursion
- 6 pulse oximetry showing oxygen saturation (SaO₂) of less than 94% (normal SaO₂ in a patient at sea level is 94–100% in air).

Fast breathing can be caused by an airway problem, lung disease or metabolic acidosis.

Table 7.1 Respiratory rates 'at rest'

Age (years)	Respiratory rate (breaths/minute)
In pregnancy	15-20*

** In pregnancy, respiratory rate does not change over that in adult women although tidal volume increases resulting in approximately a 50% increase in minute ventilation.*

The WHO suggests a breathing rate of 30 per minute or more in pregnancy as evidence of shock.

Care should be taken when interpreting single measurements. It is more useful to use trends in measurements as an indicator of improvement or deterioration.

Slow breathing rates may result from fatigue or raised intracranial pressure, or may immediately precede a respiratory arrest due to severe hypoxaemia.

Section 7: Structured approach to managing emergencies

Other signs of breathing difficulty

Chest wall recession

- Intercostal, subcostal or sternal recession reflects increased effort of breathing.
- The degree of recession indicates the severity of respiratory difficulty.
- In the patient with exhaustion, chest movement and recession will decrease.

Inspiratory or expiratory noises

- Stridor, usually inspiratory, indicates laryngeal or tracheal obstruction.
- Wheeze, predominantly expiratory, indicates lower airway obstruction.
- Volume of noise is not an indicator of severity.

Grunting

- This is observed in patients with stiff lungs in an attempt to prevent airway collapse (it represents the noise made by closure of the larynx during expiration, which is the body's attempt to increase lung volume).
- It is a sign of severe respiratory distress.

Accessory muscle use

Exceptions

Increased effort of breathing **does not occur** in three circumstances:

1. exhaustion
2. central respiratory depression (e.g. from raised intracranial pressure, poisoning or encephalopathy)
3. neuromuscular disease (e.g. poliomyelitis).

Effects of breathing failure on other physiology

Heart rate: this is increased with hypoxia, but decreases when hypoxia is severe, when bradycardia is a sign of impending cardiorespiratory arrest.

Skin colour: hypoxia first causes vasoconstriction and pallor. Cyanosis is a late sign and may indicate impending cardiorespiratory arrest. In an anaemic patient it may never be seen, however hypoxic the patient is.

Mental status: hypoxia causes initial agitation, then drowsiness, followed by loss of consciousness.

Resuscitation of breathing

Give high-flow oxygen to all patients with respiratory difficulty. Give as much oxygen as possible through a mask with a reservoir bag to any patient who is breathing but has respiratory difficulty or the other signs of hypoxia (e.g. cyanosis).

In the patient with absent or inadequate breathing, it is essential to breathe for the patient using:

- mouth-to-mouth or mouth-to-mouth-and-nose ventilation, *or*
- bag–valve–mask ventilation: if using oxygen, add a reservoir to increase the oxygen concentration.

Intubate (if skilled professionals are available) and provide assisted ventilation through the tube if long-term ventilation is needed or bag–mask ventilation is ineffective.

However, do not persist with intubation attempts without ventilating the patient intermittently with a bag and mask as necessary to prevent hypoxaemia during the intubation process.

Section 7: Structured approach to managing emergencies

Specific resuscitation measures when there is a breathing problem

- 1 Perform **needle thoracocentesis** if the diagnosis is tension pneumothorax (see Section 42). This should be followed by a chest drain.
- 2 Consider inserting a chest drain if there is major trauma to the chest (see Section 42).
- 3 Give **nebulised salbutamol** if the patient has severe, life-threatening asthma (5 mg in pregnancy). If a nebuliser is not available, use a spacer and metered-dose inhaler (100 micrograms/puff; 10 puffs initially).(see Section 30)
- 4 Give **IM adrenaline** (1 mg in pregnancy) and **nebulised salbutamol** (see above) if wheezing is due to anaphylaxis. (see Section 31)
- 5 Give **anticoagulant** (IV unfractionated heparin) if pulmonary embolus is diagnosed in pregnancy or post delivery (see Section 19)
- 6 Give **calcium gluconate** (10 mL 10% IV over 10 minutes) if respiratory arrest is due to magnesium toxicity in a patient treated for eclampsia with magnesium sulphate.(see Section 16)

Primary assessment and resuscitation of circulation

If there is no palpable pulse, a very slow heart rate < 40 beats/minute in a pregnant woman) or no “signs of life” (e.g. movements, coughing, normal breathing), cardiac arrest or near-cardiac arrest is likely, and basic life support must be started (see Section 8).

Agonal gasps (irregular, infrequent breaths) do not provide adequate oxygenation and are not for these purposes a “sign of life”.

In addition to cardiac arrest or near-arrest, shock and heart failure are additional life-threatening issues that it is important to identify.

Shock

The following clinical signs can help to identify shock (inadequate circulation) (see Section 12).

Heart rate

Heart rate increases in shock and heart failure.

Severe bradycardia due to hypoxaemia may be a sign of near cardiorespiratory arrest.

Table 7.2 Heart rates in pregnancy

	Normal range of heart rate (beats/minute)
Pregnancy	70–115*

* The heart rate in pregnancy increases by 10–15 beats per minute over that in adult women. The WHO defines a heart rate in pregnancy of 110 per minute or more as evidence of shock.

Pulse volume

Absent peripheral pulses or reduced strength of central pulses can signify shock.

Capillary refill time (CRT)

- Pressure on the centre of the sternum or fingernail for 5 seconds should be followed by return of the circulation to the skin within 3 seconds or less. CRT may be prolonged by shock, cold environment, or the vasoconstriction that occurs as a fever develops.
- Prolonged CRT is not a specific or sensitive sign of shock, and should not be used alone as a guide to the need for or the response to treatment.

Blood pressure

The cuff should cover at least 80% of the length of the upper arm, and the bladder should be more than two-thirds of the arm’s circumference. In pregnancy the largest possible cuff should be used to avoid missing a raised blood pressure.

Korotkoff phase 5 (K5, disappearance of sound) should be used to measure diastolic pressure.

Korotkoff phase 5A (K5A, muffling or softening of sound) should only be used if the sound does not disappear until near to zero cuff pressure.

Section 7: Structured approach to managing emergencies

In pregnancy the patient should ideally be sitting or lying in the lateral tilt positions when pressure is measured. In both of these positions, the cuff must be level with the heart.

Hypotension is a late sign of circulatory failure in pregnancy, and will be rapidly followed by cardiorespiratory arrest unless it is treated urgently.

WHO defines normal adult BP as 120/80 mmHg. Blood pressure falls early in pregnancy due to a decrease in systemic vascular resistance. It is usually 10 mmHg below baseline and reaches a lowest mean value of 105/60 mmHg in the second trimester. During the third trimester it gradually returns to the pre-pregnancy level at term.

The normal systolic blood pressure in pregnancy is in the range 95–135 mmHg. The normal diastolic blood pressure is in the range 60–85 mmHg.

The WHO suggests a systolic BP of < 90 mmHg in pregnancy as evidence of shock. A systolic BP < 95 mmHg should prompt a search for other possible indicators of developing shock.

The cardiovascular system in pregnancy compensates well initially in shock. **Hypotension is a late and often sudden sign of decompensation and, if not reversed, will be rapidly followed by death. Serial measurements of blood pressure should be performed frequently.**

Effects of circulatory failure on other organs

Respiratory system: tachypnoea and hyperventilation occur as a result of the acidosis caused by poor tissue perfusion.

Skin: pale or mottled skin indicates poor perfusion.

Mental status: circulatory failure causes initial agitation, then drowsiness, followed by unconsciousness.

Urine output: a reduction in urine output to < 30 mL/hour in pregnancy indicates inadequate renal perfusion.

In pregnancy: fetal compromise can be the first sign of shock in the mother.

The **WHO definition of shock** is cold hands, *plus* CRT of > 3 seconds, *plus* a weak and rapid pulse.

Life-threatening shock is usually associated with:

- severe tachycardia
- a weak-volume pulse (ideally assess centrally: brachial, femoral or carotid)
- low blood pressure (this is a late sign)
- extreme central pallor (if due to severe anaemia)
- raised respiratory rate (due to acidosis)
- poor skin circulation, with a CRT of > 3 seconds
- reduced conscious level.

Remember that anaphylaxis is one cause of shock, and typically there is a relevant history and other signs such as angio-oedema and urticaria.

Remember that if shock is due to heart failure, fluid overload will be fatal (for information on how to recognise and manage heart failure, see Section 29).

Resuscitation in shock

For cardiac arrest or near arrest, **chest compressions** should be undertaken. (Section 8)

Ensure that there is an open and secure airway.

Give **high-flow oxygen** to any patient who has an inadequate circulation (whether due to shock or to heart failure). This should be administered via a face mask with a reservoir bag (or an endotracheal tube if intubation has been necessary).

Section 7: Structured approach to managing emergencies

Venous or intra-osseous access should be obtained and blood for essential tests taken (haemoglobin, cross-matching, blood clotting factors, and urea and electrolytes if possible).

Lateral tilt in shock In pregnancy and after 20 weeks' gestation (whenever the uterus can be palpated abdominally), place the patient in the left lateral tilt position to prevent uterine pressure on the abdominal and pelvic veins stopping blood return to the heart.

In all patients with shock, **elevate the legs.**

Fluids in shock

In most cases of shock, if obvious bleeding is the cause then the first priority must be to stop this. IV or IO fluids are then required as the immediate resuscitation treatment, once the airway has been opened and secured and oxygen is being given. However, different causes of shock require different approaches to treatment, as described below.

- If loss of fluid causing **hypovolaemia** is the cause of shock: give an immediate **IV/IO bolus of 500-1000 mL of crystalloid (usually Ringer-lactate or Hartmann's solution)** provided that heart failure is not present (see above).
- If the loss of fluid causing shock is due to **severe gastroenteritis**, there will usually be evidence of severe dehydration and a history of profound or long-standing diarrhoea. Give 500-1000 mL of **Ringer-lactate or Hartmann's solution as an initial IV or IO bolus** as rapidly as possible, reassess, and then repeat if necessary. In cases of cholera, up to 3 litres may be required in pregnant patients. Additional potassium will usually be required (see pages XX)
- If the loss of fluid causing shock is due to **bleeding**, which is **one of the commonest causes in pregnancy**, give crystalloid immediately and then try to obtain blood for transfusion as rapidly as possible, ideally fresh blood. Give O-negative blood if this is available.

The concept of **targeted crystalloid fluid resuscitation** is important and requires urgent research into management if the cause of hypovolaemic shock is haemorrhage due to penetrating injury in trauma or to obstetric haemorrhage such as ruptured ectopic pregnancy. Here the initial boluses of IV crystalloids required to treat shock would only be given to keep the vital organs (especially the brain, heart and kidneys) perfused before surgery and/or specific medical treatments to stop the bleeding have started to take effect.

Fresh blood is particularly useful to combat the coagulopathy that occurs in major blood loss if specific coagulation components such as platelets are unavailable.

Giving too much IV crystalloid can increase the blood pressure and theoretically increase bleeding by disrupting early clot formation. IV crystalloid also dilutes the red cells (and coagulation factors) in the circulation, but whether or not this could reduce oxygen-carrying capacity requires further research.

We suggest that when giving boluses of crystalloid in **shock due to bleeding (before blood is available and before procedures undertaken to stop haemorrhage are effective)** in patients with penetrating major trauma or obstetric haemorrhage, only the amount needed to maintain the blood pressure at a level sufficient to perfuse the vital organs is given. There is no clear evidence to indicate the precise blood pressure that should be achieved in pregnant women who are in shock due to haemorrhage. **Adequate perfusion of vital organs may best be indicated by a radial pulse that can be palpated and a conscious level of A or V on the AVPU scale (i.e. the woman is either awake or will respond by opening their eyes when spoken to).** During pregnancy, the adequacy of the fetal heart rate may also be helpful.

Section 7: Structured approach to managing emergencies

In this situation, therefore, and to maintain a palpable radial pulse in pregnancy, start with IV boluses of 500 mL of crystalloid or ideally blood, and reassess after each bolus.

In situations where there is brisk active blood loss and delay in obtaining blood or effective intervention to halt the bleeding, several boluses of crystalloids may be required. **The importance of undertaking measures to halt the bleeding and obtaining blood for transfusion rapidly cannot be overstated.**

- If shock is due to **septicaemia with purpura** (meningococcus or dengue), give IV or IO boluses of Ringer-lactate or Hartmann's solution as fast as possible, 1 litre in pregnant women, and then reassess. Usually at least 2–3 litres in pregnant women will be required to overcome shock (see Section 12). In this situation, **inotropes** may be valuable if they are available and safe to use (see Section 12).
- If shock is due to **anaphylaxis**, give **adrenaline**, 1 mg (1 mL of 1 in 1000) IM in pregnant women, in addition to IV or IO fluid.(see Section 31)
- If shock is due to **severe anaemia** (see Section 13), IV crystalloid boluses such as Ringer-lactate or Hartmann's solution must be given with extreme care (due to the risk of heart failure). As soon as possible, give blood carefully (50 mL in pregnant women, over 15 minutes) and then reassess and repeat if it is safe to do so.

Partial exchange transfusion may be helpful in this situation, especially if it is possible to access a large superficial vein in the antecubital fossa. Successively remove 20-mL aliquots of the patient's blood and replace each 20 mL with 40 mL of packed donor red blood cells until shock has resolved.

Heart failure (see Section 29)

This life-threatening situation can be seen in severe anaemia, after fluid overload, in the presence of structural heart disease and with severe hypertension in pregnancy. It is important to distinguish heart failure from shock, as the resuscitation required is different. Some of the following signs will be present in heart failure:

- tachycardia out of proportion to respiratory difficulty
- severe palmar pallor (if anaemia is the cause)
- raised jugular venous pressure
- gallop rhythm on auscultation of the heart
- some heart murmurs (if structural heart defect is responsible)
- an enlarged, sometimes tender, liver
- crepitations on listening to the lung bases

In pregnancy, **severe hypertension** can cause heart failure (check the blood pressure; patients with values above 170/110 mmHg can present with heart failure).

Resuscitation for heart failure in pregnancy

1. **Sit the patient up.**
2. Give **oxygen**.
3. Give **furosemide** 40 mg IV and repeat if required.
4. Consider giving **morphine** (3 mg in pregnancy), and reassess. Morphine should be used with caution, especially in patients with altered mental status and impaired respiratory drive.
5. If the patient has severe anaemia, consider **exchange transfusion**.

Primary assessment and resuscitation of neurological failure (disability)

Always assess and treat Airway and haemorrhage control, Breathing and Circulation problems before undertaking neurological assessment.

Section 7: Structured approach to managing emergencies

Primary assessment: Conscious level: AVPU

Alert is the normal state for an awake person. If the patient does not respond to **Voice** (i.e. being spoken to and asked 'Are you all right?'), it is important that assessment of the response to **Pain** is undertaken next. A painful central stimulus can be delivered by sternal pressure, by supra-orbital ridge pressure or by pulling frontal hair. A patient who is **Unresponsive or who only responds to Pain** has a significant degree of coma which can seriously interfere with vital Airway and Breathing functions.

A	ALERT
V	responds to VOICE
P	responds to PAIN
U	UNRESPONSIVE

Fits

Generalised convulsions, also known as 'fits' or 'seizures', can seriously interfere with vital Airway and Breathing functions, both during the fit itself and immediately afterwards, when lowered levels of consciousness may be present.

Posture

Many patients who have a serious illness in any system are hypotonic. Stiff posturing, such as that shown by decorticate (flexed arms, extended legs) or decerebrate (extended arms, extended legs) posturing, is a sign of serious brain dysfunction. These postures can be mistaken for the tonic phase of a convulsion. Alternatively, a painful stimulus may be necessary to elicit these postures.

Severe extension of the neck due to upper airway obstruction can mimic the opisthotonus that occurs with meningeal irritation.

Pupils

Many drugs and cerebral lesions have effects on pupil size and reactions. However, the most important pupillary signs to seek are dilatation, unreactivity and inequality, which suggest possible serious brain disorders.

Always check blood glucose levels or suspect hypoglycaemia. Hypoglycaemia with a blood glucose level of less than 2.5 mmol/L (45 mg/dL) can cause impaired consciousness, coma or fits.

Respiratory effects of central neurological failure

The presence of any abnormal respiratory pattern in a patient with coma suggests mid- or hindbrain dysfunction.

Circulatory effects of central neurological failure

Systemic hypertension with sinus bradycardia (Cushing's response) indicates compression of the medulla oblongata caused by herniation of the cerebellar tonsils through the foramen magnum.

This is a late and pre-terminal sign.

Raised intracranial pressure (ICP) may cause:

- *hyperventilation*
- slow sighing respirations
- apnoea
- hypertension
- bradycardia.

Section 7: Structured approach to managing emergencies

Resuscitation

- 1 If the patient is unconscious (P or U on the AVPU scale) but their airway and breathing are adequate, place them in the **recovery position**, so that if they vomit there is less likelihood of aspiration because when unconscious, the gag reflex may not be operative.
- 2 If the patient is unconscious or fitting, **always give oxygen**.
- 3 If **hypoglycaemia** is a cause of reduced consciousness (or a suspected cause, but immediate blood glucose measurements are not possible), treatment with glucose is urgently required. In pregnancy give 100 mL of 25% glucose IV or IO. (Make 100 mL of 25% glucose by adding 50 mL of 50% glucose to 50 mL of Ringer-lactate or Hartmann's solution). Recheck the blood glucose level after 20 minutes, and if the level is low (< 2.5 mmol/litre or < 45 mg/dL), repeat the IV/IO glucose.
- 4 If fitting occurs in pregnancy, give **magnesium sulphate** (see Section 16).
- 5 To gain time in **acutely raised intracranial pressure (ICP) in pregnancy** (e.g. in cases of head injury), consider the use of IV **mannitol**. Give 20 grams of 20% mannitol over 15 minutes as soon as cerebral oedema is suspected. Repeat every 4–6 hours. This will draw fluid out of the brain for a short while, thereby temporarily reducing the ICP. Because the effect of mannitol is only short-lived (a matter of hours), it is used to gain time while definitive care is being set up (e.g. surgical intervention to drain an extradural or subdural haematoma).
- 6 In any case where **meningitis** or **encephalitis** is suspected, it is vital that suitable antibiotics and/or antiviral drugs are started IV or IO as soon as the condition is suspected.

Secondary assessment and emergency treatments

The secondary assessment takes place once vital functions have been assessed and the initial resuscitation of those vital functions has been started. Primary assessment and resuscitation can usually be undertaken in less than 1 minute if the patient does not have a life-threatening airway, breathing, circulation or neurological problem.

Secondary assessment includes a *focused medical history*, a *focused clinical examination* and *specific investigations* designed to establish which emergency treatments might benefit the patient.

At the end of secondary assessment, the practitioner should have a better understanding of the illness or component of injury likely to be affecting the patient, and may have formulated a differential diagnosis. Emergency treatments will be appropriate at this stage – to treat either specific disorders (e.g. asthma) or conditions (e.g. raised intracranial pressure). Emergency treatments will be undertaken at this stage in addition to those given as part of resuscitation/life-saving treatments, in order to manage specific components of serious illnesses or injuries (e.g. steroids for asthma, Caesarean section for antepartum haemorrhage).

The history often provides the vital clues. Do not forget to ask any health worker who has seen the patient about the initial condition and about treatments and the response to treatments that have already been given.

The secondary assessment is not intended to complete the diagnostic process, but rather it aims to identify any problems that require emergency treatment.

Secondary assessment of airway and breathing; Examples of emergency treatment for airway and breathing

- Stridor following ingestion or injection of a known allergen suggests **anaphylaxis** (see Section 31). Patients in whom this is likely should have received IM and nebulised adrenaline (1 mg in pregnancy as resuscitation treatment. IV or oral **steroids** would then be part of emergency treatment.
- Patients with a history of asthma or with wheeze, significant respiratory distress and/or hypoxia should receive inhaled salbutamol and oxygen as resuscitation, but then need

Section 7: Structured approach to managing emergencies

oral steroids and further inhaled bronchodilators as emergency treatment (see Section 30).

- In acidotic breathing, measure blood glucose levels to confirm diabetic ketoacidosis. A bolus of IV Ringer-lactate or Hartmann's solution will already have been given as resuscitation for any shock due to dehydration, and **insulin** can now be given as emergency treatment (see Section 32).
- In clinically suspected pulmonary embolus in pregnancy, IV **unfractionated heparin** should be given as resuscitation, and subcutaneous **low-molecular-weight heparin** should be given as emergency treatment (see Section 19).

Secondary assessment of circulation; Examples of emergency treatment for circulation

- Further IV/IO **boluses of fluid** should be considered in shocked patients with hypovolaemia from gastroenteritis or with sepsis who have not shown a sustained improvement in response to the first bolus given at resuscitation (see Sections 12 and 35).
- However, in trauma, if there is uncontrolled internal bleeding, **early surgical intervention** has priority, and too much IV fluid may be harmful. **Continued blood transfusion** is an emergency treatment after the initial resuscitation (see Section 42).
- Consider **IV broad-spectrum antibiotics** as emergency treatment for shock in patients with no obvious fluid loss, as sepsis is likely. Antibiotics are essential if purpura is present, as a diagnosis of meningococcal infection is likely (see Section 12).
- If anaphylaxis is suspected, IM adrenaline 1 mg in pregnancy, in addition to fluid boluses, should be given as resuscitation treatment, and **steroids and antihistamines** should be given as emergency treatment (see Section 31).
- Targeted treatment is needed for obstetric emergencies that are known to cause shock. These include sepsis (for which **antibiotics** are needed), and antepartum or postpartum haemorrhage (for which specific treatment including **medication** and **urgent surgery** is needed together with **replacement of lost blood**).
- Surgical advice and interventions for certain gastrointestinal emergencies such as volvulus would constitute emergency treatment. The following symptoms and signs may suggest intra-abdominal emergencies: vomiting, abdominal pain, abdominal tenderness and/or rigidity, lack of bowel sounds, rectal bleeding, abdominal mass.

Secondary assessment of neurological failure (disability): Examples of emergency treatment for neurological failure

- If hypoglycaemia with a blood glucose level of less than 2.5 mmol/L (45 mg/dL) is a possible diagnosis, it will have been treated as part of resuscitation, but the prevention of further hypoglycaemia by IV glucose infusion represents emergency treatment. Remember that there will be a reason for the hypoglycaemia, so further monitoring and treatment are needed until the patient is drinking appropriate fluids or has an IV infusion in place through which dextrose can be given.
- If convulsions persist after initial anticonvulsant drugs, treatment with further doses of anticonvulsants (see Section 33) represents emergency treatment.
- If there is evidence of raised intracranial pressure (i.e. decreased conscious level, abnormal posturing and/or abnormal ocular motor reflexes), the patient should receive oxygen and bag-valve-mask ventilation as resuscitation, if they have apnoea or slow or poor breathing. Emergency treatment could include:
 - nursing with head in-line and 20–30 degrees head-up position (to aid cerebral venous drainage)
 - repeat IV infusion with mannitol 20 grams of 20% over 15 minutes however, the treatment becomes less effective with each dose.
 - in more long-standing raised ICP, caused by tumours in the brain, dexamethasone will help to reduce raised ICP for a few days while specialist neurosurgical

Section 7: Structured approach to managing emergencies

intervention is sought, or as palliation. The initial dose is 25 mg for patients over 35 kg and 20 mg for patients less than 35 kg, followed by a sliding scale of 4 mg every 3 hours for 3 days, then every 6 hours for 1 day, and continuing to decrease by 1–2 mg per day.

- In patients with a depressed conscious level or convulsions, antibiotics are urgently required, but then consider encephalitis and give acyclovir as appropriate, as emergency treatment.
- In unconscious patients with pinpoint pupils, consider the possibility of opiate poisoning. After supporting breathing if necessary, a trial of naloxone should be given as emergency treatment.(see Section 44)

Section 8: Basic life support in pregnancy

Basic life support (BLS) is a technique that can be employed by one or more rescuers to support the respiratory and circulatory functions of a collapsed patient using no or minimum equipment.

Resuscitation from cardiac arrest in pregnant women

The sequence here includes 5 preliminary rescue breaths and a subsequent ratio of 15 chest compressions to 2 breaths.

Figure 8.1 Algorithm for basic life support in pregnant women.

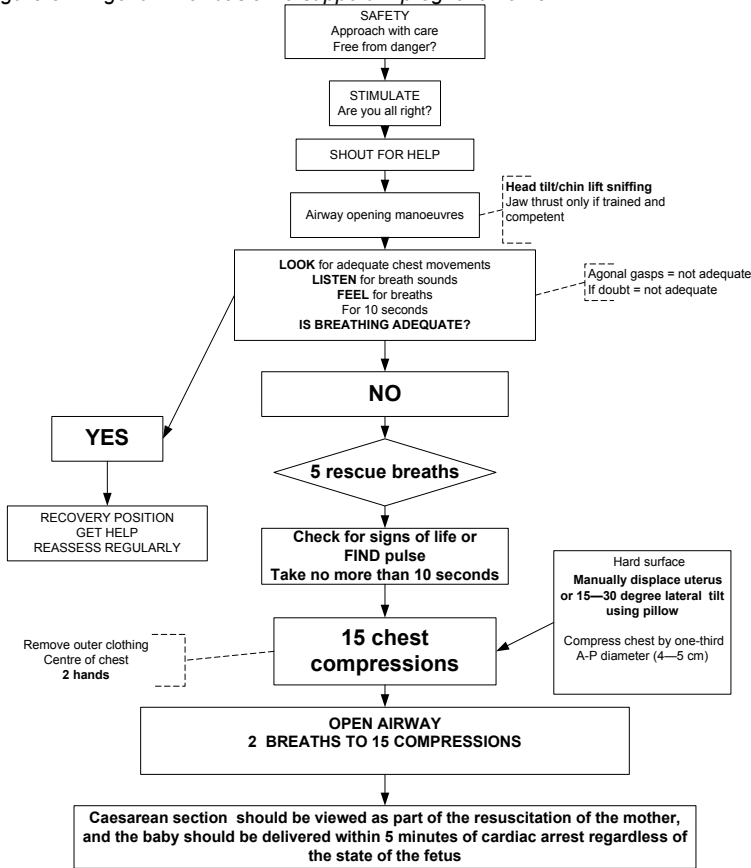

The initial approach: the three S's

1. **Safety:** it is essential that the rescuer does not become a second victim. Therefore they should approach the patient with care, and remove the patient from any continuing source of danger if necessary.
2. **Stimulate:** ask the question 'Are you all right?' in order to establish the state of consciousness of the patient.
3. **Shout:** this is essential because help will be needed.

Section 8: Basic life support and CPR in pregnancy

If more than one rescuer is present, one person should start basic life support. The second person should activate the Emergency Medical Services (EMS) system and then returns to assist in the basic life support effort.

'Are you all right?'

An initial simple assessment of responsiveness consists of asking the patient 'Are you all right?' and gently shaking her by the shoulder.

In cases associated with trauma, or possible trauma, the cervical spine should be immobilised during this procedure by placing one hand firmly on the forehead while one of the patient's shoulders is shaken.

Airway-opening actions

An obstructed airway may be the primary problem, and correction of the obstruction can result in recovery without the need for further intervention. If the patient is unconscious but breathing, the recovery position should be used. For pregnant women with an abdominally palpable uterus the left lateral position must be adopted.

If the patient is not breathing, this may be because the airway is blocked by the tongue falling back and obstructing the pharynx. Attempt to open the airway using the **head tilt/chin lift manoeuvre**. The rescuer places their nearest hand on the patient's forehead, and applies pressure to tilt the head back gently. The correct position is '**sniffing**' (**nose up in the air**) in pregnancy (see Figure 8.2).

Figure 8.2 Head tilt with chin lift in 'sniffing' position in pregnancy



The fingers of the other hand should then be placed under the chin, and the chin of the supine patient should be lifted upwards. As this action may close the patient's mouth, it may be necessary to use the thumb of the same hand to part the lips slightly.

As an alternative to the head tilt/chin lift, the **jaw thrust manoeuvre** can be very effective, but requires more training and experience.

Figure 8.3 Jaw thrust to open airway

Jaw thrust is achieved by placing two or three fingers under the angle of the mandible bilaterally, and lifting the jaw upward (see Figure 8.3). This is potentially safer than the head tilt/chin lift if there is a history of major trauma, as the latter manoeuvre may exacerbate a cervical spine injury. **BUT Airway opening is always the most important action which must be achieved, and should always take precedence over concerns about a possible cervical spine injury.**



The adequate opening of the airway should then be assessed by:

Section 8: Basic life support and CPR in pregnancy

- **looking** for adequate chest movements
- **listening** for breath sounds
- **feeling** for breaths.

This is best achieved by the rescuer placing their face above that of the patient, with the ear over the nose, the cheek over the mouth, and the eyes looking along the line of the chest. They should take no longer than 10 seconds to assess breathing.

If there is anything obvious in the mouth and it is easy to reach, remove it. **Do not perform a blind finger sweep in the mouth.** A blind finger sweep can damage the soft palate, and foreign bodies may be forced further down the airway and become lodged below the vocal cords.

Breathing actions

If airway-opening techniques do not result in the resumption of adequate breathing within 10 seconds, and a self-inflating bag–mask system is not available, then the rescuer should commence mouth-to-mouth exhaled air resuscitation.

Definition of adequate breathing

A patient may have very slow or shallow breathing, or take infrequent, noisy, agonal gasps. Do not confuse this with normal breathing.

Rescue breaths

If in doubt about the adequacy of breathing, five initial rescue breaths should be given. While the airway is held open, the rescuer breathes in and seals their mouth around the patient's mouth (see Figure 8.4). The nose should be pinched using the thumb and index finger of the hand maintaining head tilt. Slow exhalation, 1–2 seconds, by the rescuer should result in the patient's chest rising. The rescuer should take a further breath him- or herself before the next rescue breath.

Figure 8.4 Mouth-to-mouth breaths with pinched nose in sniffing position in pregnancy



General guidance for exhaled air resuscitation

- The chest should be seen to rise.
- Slow breaths at the lowest pressure reduce gastric distension.
- Firm gentle pressure on the cricoid cartilage may reduce gastric distension with air.

- If the chest does not rise, the airway is not open. The usual cause is failure to correctly apply the airway-opening techniques discussed earlier. The first step is to readjust the head tilt/chin lift position and try again. If this is not successful, jaw thrust should be tried. If two rescuers are present, one should maintain the airway while the other breathes for the patient.

Section 8: Basic life support and CPR in pregnancy

- Failure of both head tilt/chin lift and jaw thrust should lead to suspicion that a foreign body is causing the obstruction (see below).
- While performing rescue breaths, the presence of a gag reflex or coughing is a positive sign of life (see below).

Circulation actions

Once the initial five breaths have been given successfully, circulation should be assessed and managed as follows.

Check signs of life and/or pulse (take no more than 10 seconds)

Even experienced health professionals can find it difficult to be certain that the pulse is absent within 10 seconds, so the absence of '**signs of life**' is the best indication for starting chest compressions. 'Signs of life' include movement, coughing, gagging or normal breathing (but not agonal gasps, which are irregular, infrequent breaths). Thus the absence of evidence of normal breathing, coughing or gagging (which may be noticed during rescue breaths) or any spontaneous movement is an indication for chest compressions.

Inadequacy of circulation is also indicated by the absence of a central pulse for up to 10 seconds, but it can be difficult and therefore time wasting to be certain about this – hence the current emphasis on assessing the presence of 'signs of life.'

In pregnancy the carotid pulse in the neck can be palpated.

Start chest compressions if:

- there are no signs of life *or*
- there is no pulse *or*
- there is a slow pulse (less than 40 beats/minute in an unconscious pregnant woman with poor perfusion)

'Unnecessary' chest compressions are almost never damaging. It is important not to waste vital seconds before starting chest compressions after oxygenating the patient with the rescue breaths. If there are signs of life and the pulse is present (and has an adequate rate, with good perfusion), but apnoea persists, exhaled air resuscitation must be continued until spontaneous breathing resumes.

Chest compressions

For the best output, the patient must be placed on their back, on a hard surface. The chest should be compressed by a third of its depth.

Figure 8.5 Chest compressions using two hands in pregnancy



Position for chest compressions

Chest compressions should compress the lower half of the sternum. In pregnancy compressions

Section 8: Basic life support and CPR in pregnancy

may be achieved most easily by using both hands with the fingers interlocked (Figure 8.5). The rescuer may choose one or two hands to achieve the desired compression of one third of the depth of the chest.

15 compressions should be given to 2 ventilations.

Technique for giving chest compressions in pregnancy

- Kneel by the side of the patient, who must be positioned on a firm surface, the uterus having been displaced if appropriate (see below).
- Place the heel of one hand in the centre of the patient's chest.
- Place the heel of your other hand on top of the first hand.
- Interlock the fingers of your hands and ensure that pressure is not applied over the patient's ribs. Do not apply any pressure over the upper abdomen or the bottom end of the bony sternum (breastbone).
- Position yourself vertically above the patient's chest and, with your arms straight, press down on the sternum to a depth of 5–6 cm.
- After each compression, release all the pressure on the chest without losing contact between your hands and the sternum.
- Repeat at a rate of about 100–120 times a minute (a little less than 2 compressions a second).
- Compression and release should take an equal amount of time.

Technique for giving breaths in pregnancy (see Figure 8.4)

- After 15 compressions, open the airway again using the head tilt and chin lift (use the jaw thrust if you are experienced and capable of doing it properly and there are two rescuers)
- Pinch the soft part of the patient's nose closed, using the index finger and thumb of your hand on their forehead.
- Allow the patient's mouth to open, but maintain chin lift.
- Take a normal breath and place your lips around the patient's mouth, making sure that you have a good seal. If you have a bag–valve mask, this can be used instead of mouth-to-mouth basic life support in all age groups.
- Blow steadily into the patient's mouth while watching for their chest to rise; take about 1 second to make their chest rise, as in normal breathing; this is an effective rescue breath.
- Maintaining the head tilt and chin lift, take your mouth away from the patient and watch for their chest to fall as air is exhaled.
- Take another normal breath and blow into the patient's mouth once more to give a total of two effective rescue breaths. Then return your hands without delay to the correct position on the sternum and give a further 15 chest compressions.
- Continue with chest compressions and rescue breaths in a ratio of 15:2.
- If your rescue breaths do not make the chest rise as in normal breathing, then before your next attempt:
 - check the patient's mouth and remove any visible obstruction
 - recheck that there is adequate head tilt and chin lift
 - try the jaw thrust if you are able to do this effectively.
- Do not attempt more than two breaths each time before returning to chest compressions.
- **If there is more than one rescuer present, a different person should take over CPR about every 2 minutes to prevent fatigue. Ensure that there is minimal delay during the changeover between rescuers.**
- Stop to recheck the patient only if they start breathing **normally**; otherwise **do not interrupt resuscitation.**

Continuing cardiopulmonary resuscitation

The compression rate is 100–120 compressions per minute. A ratio of 15 compressions to 2 ventilations is maintained irrespective of the number of rescuers. With pauses for ventilation there

Section 8: Basic life support and CPR in pregnancy

will be less than 100–120 compressions per minute, although the **rate** is 100–120 per minute. Compressions can be recommenced at the end of inspiration and may augment exhalation.

If no help has arrived, the emergency services must be contacted after 1 minute of cardiopulmonary resuscitation. **Apart from this interruption to summon help, basic life support must not be interrupted unless the patient moves or takes a breath.**

Effective chest compressions are tiring for the rescuer. Continually check that the compressions and ventilations are satisfactory and, if possible, alternate the rescuers involved in this task.

Any time spent readjusting the airway or re-establishing the correct position for compressions will seriously decrease the number of cycles given per minute. This can be a real problem for the solo rescuer, and there is no easy solution.

If recovery occurs and signs of life return, place the patient in the recovery position and continue to reassess them and ensure that specialist help arrives.

Special circulation actions in pregnancy > 20 weeks (see Figures 8.6 and 8.7)

Place the patient on a hard surface in the left lateral tilt position to overcome vena caval compression. This can be achieved with a wedge placed under the right hip to displace the gravid uterus to the left, or it is possible to improvise with a pillow or coat. If an assistant is available, they can displace the uterus to the left side of the vena cava (Figure 8.7). Effective chest compressions can be accomplished at a 15–30° tilt to the left, but displacement of the uterus is the more effective method.

Figure 8.6 The supine hypotensive syndrome. On the left the mother is lying on her back, her uterus is occluding her inferior vena cava. . On the right the mother is lying in a lateral tilt position (the recovery position here) and the inferior vena cava is no longer compressed.

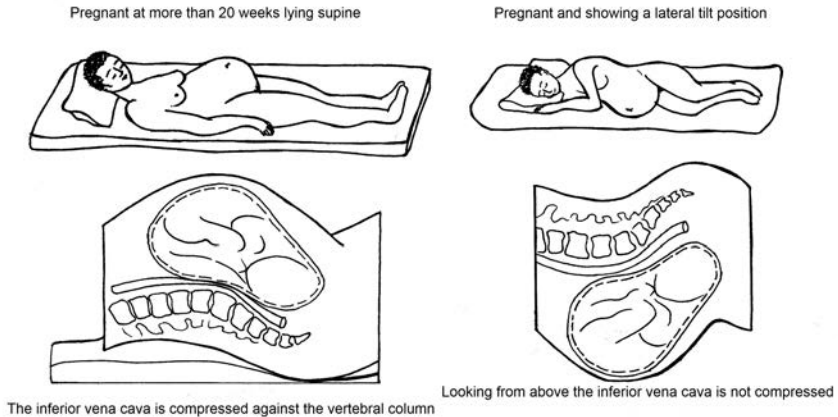

Figure 8.7 Displacing the pregnant uterus manually



Section 8: Basic life support and CPR in pregnancy

Chest-compression-only CPR.

- If you either unable or unwilling to give rescue breaths, give chest compressions only. This is particularly relevant in countries where there is a high prevalence of HIV, hepatitis or TB (see below).
- If chest compressions only are given, these should be continuous at a rate of 100 compressions per minute.
- Stop to recheck the patient only if they start to breathe **normally**; otherwise do not interrupt resuscitation.

Continue resuscitation until:

- qualified help arrives and takes over *or*
- the patient starts breathing normally *or*
- you become exhausted.

If available, bag–valve–mask ventilation is preferable to mouth-to-mouth ventilation.

The recovery position (Figure 8.8)

The patient should be placed in a stable, lateral position that ensures maintenance of an open airway with free drainage of fluid from the mouth, ability to monitor and gain access to the patient, security of the cervical spine and attention to pressure points (see Figure 8.8).

- Remove the patient's spectacles (if present).
- Kneel beside the patient and make sure that both of their legs are straight.
- Place the arm nearest to you out at right angles to their body, elbow bent with the hand palm upmost.
- Bring the far arm across the chest, and hold the back of the hand against the patient's cheek nearest to you.
- With your other hand, grasp the far leg just above the knee and pull it up, keeping the foot on the ground.
- Keeping their hand pressed against their cheek, pull on the far leg to roll the patient towards you on to their side.
- Adjust the upper leg so that both the hip and knee are bent at right angles.
- Tilt the head back to make sure the airway remains open.
- Adjust the hand under the cheek, if necessary, to keep the head tilted.
- Check the patient's breathing regularly.

If the patient has to be kept in the recovery position for **more than 30 minutes**, turn them to the opposite side in order to relieve the pressure on the lower arm.

Figure 8.8 The recovery position



Cardiac arrest and cardiopulmonary resuscitation in pregnancy

Physiologic changes of pregnancy as they relate to cardiopulmonary resuscitation

Section 8: Basic life support and CPR in pregnancy

Pregnant women or girls more easily develop hypoxaemia. The enlarged uterus along with the resultant upward displacement of the abdominal viscera decreases lung compliance. The most serious problem is aorto-caval compression in the supine position. During closed-chest cardiac compression the best cardiac output that can be achieved is between one-fourth to one-third of normal. Although many factors contribute to this, poor venous return to the heart is of paramount importance. At term the vena cava is completely occluded in 90 percent of supine pregnant patients. This results in a decrease in cardiac stroke volume of as much as 70%.

Caesarean section early in resuscitation vastly improves the effectiveness of maternal resuscitation.

Peri-mortem Caesarean section should be performed as soon as possible. This will immediately relieve the vena caval obstruction and increase the chance of survival for both infant and pregnant woman or girl. CPR must be continued throughout the procedure until spontaneous and effective cardiac activity occurs.

Without caesarean section, <10% arresting in hospital will survive to discharge. Removal of the infant improves maternal circulation during resuscitation – cardiac output immediately increases 20 – 25%.

When to perform it

All the evidence suggests that a Caesarean delivery should begin within 4 minutes of cardiac arrest and be accomplished by 5 minutes. In practice this means that preparations for surgical evacuation of the uterus should begin almost at the same time as CPR following cardiac arrest. Pregnant women develop anoxia faster than non-pregnant women, and can suffer irreversible brain damage within 4–6 minutes of cardiac arrest. CPR should be continued throughout the Caesarean section and afterwards, as this increases the likelihood of a successful neonatal and maternal outcome.

Where to perform it

The woman should **not** be transferred to an operating theatre as this will waste time. She should be delivered at the site of collapse unless this is physically impossible. Diathermy will not be needed, as blood loss is minimal in patients with no cardiac output. If the mother is successfully resuscitated, she can be moved to theatre to be anaesthetised and to complete the operation.

How to perform it

A minimal amount of equipment is required in this situation. Sterile preparation and drapes are unlikely to improve survival. A surgical knife is sufficient.

Perform the CS with a midline vertical incision, or whatever the operator is most used to doing, and remove the baby as fast as possible. Remove lateral tilt when baby is delivered.

No one surgical approach in particular is recommended, and the choice of approach should be based on operator preference. The classical midline abdominal approach is aided by the natural diastasis of recti abdomini that occurs in late pregnancy and the relatively bloodless field in this situation. However, many obstetricians are more familiar with a lower transverse abdominal incision and can deliver a baby in less than 1 minute.

Open cardiac massage during surgery is a possibility when the abdomen is already open and the heart can be reached relatively easily through the diaphragm (if a midline approach has been used).

An anaesthetist should attend at the earliest opportunity to provide a protected airway, ensure continuity of effective chest compressions and adequate ventilation breaths, and help to determine and treat any underlying cause.

If resuscitation is successful and the mother regains a cardiac output, appropriate anaesthesia and pain relief will be required and the woman should be moved to a theatre to complete the operation.

Section 9: Emergency skills

Section 9: Skills needed in an emergency (for procedures undertaken when there is time to plan see Textbook)

AIRWAY: Equipment and skills for opening and maintaining the airway

Suction

Remove blood and secretions from the mouth with a rigid wide-bore suction tube (such as a Yankauer) under direct vision **taking care not to damage delicate tissue or induce vomiting**. If attempts to clear the airway do not result in spontaneous breathing, this may be because the airway is still not open or because the airway is open but there is no breathing.

Oro-pharyngeal airway

Figures 9.1 and 9.2



Correct Size

The oro-pharyngeal or Guedel airway is used in the unconscious or obtunded patient to provide an open airway channel between the tongue and the posterior pharyngeal wall. In the awake patient or lightly unconscious patient with an intact gag reflex, it may not be tolerated and may induce vomiting, laryngospasm or apnoea and is therefore potentially dangerous.

A correctly sized oro-pharyngeal airway when placed with its flange at the centre of the incisor teeth, then curved around the face, will reach the angle of the mandible. Too small an airway may be ineffective; too large an airway may cause laryngospasm. Either may cause mucosal trauma or may worsen airway obstruction. **Reassessment following placement** is therefore a vital part of safe insertion of an airway device.

The twist technique is used in pregnancy and means that the convex side of the airway is used to depress the tongue as the airway is pushed into the mouth (Figure 9.3). It is essential not to push the tongue back.

However, in the neonate, as the tongue is bigger relative to the size of the mouth, you can't turn it over after it's in the back of the mouth without causing trauma; hence the tongue is controlled with a spatula and not by the reversed airway. With neonates use the spatula to depress the tongue and place the airway without rotation. (Figure 9.4)

Insertion of one of these devices should result in improvement in the patient's condition. If it does not occur then a reappraisal of the choice or size of airway is urgently required.

Section 9: Emergency skills

Figure 9.3 Inserting an airway in pregnancy



Figure 9.4 Inserting an oro-pharyngeal airway in a neonate (that is without rotation). A tongue depressor may be helpful

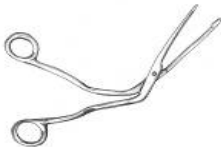

Figure 9.5

Magill's forceps Used to grasp a foreign body in the throat and remove it.

BREATHING: Equipment and skills for helping the patient to breathe **Oxygen**

Give oxygen if respiratory distress (recessions, nasal flaring, head bobbing etc.) or if cyanosis (blueness) is central (around lips and tongue or inside mouth or if shocked or if fitting). If SaO_2 monitoring is available give O_2 if $\text{SaO}_2 < 94\%$ consistently (unless at high altitude)

If oxygen supplies are limited, use oxygen at sufficient flow rates to maintain oxygen saturations at $>94\%$. If using low flow rates do not use reservoir bag

If using oxygen mask, ensure that mask is large enough to cover mouth and nose. Both low and high flow O_2 (up to 15l/min) can be given. Hold mask in place using the elastic strap around back of head. (Figure 9.6)

Section 9: Emergency skills

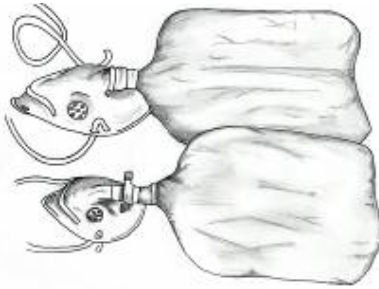

Figure 9.6 Mask with reservoir bag

A mask with a reservoir bag (Figure 9.6) allows up to 100% oxygen to be delivered. Without a reservoir, it is only possible to deliver around 40%.

Nasal cannula (Figure 9.7) come in 3 sizes small, medium, large to give O₂ concentrations of up to 40%. Nasal cannula have a curved appearance; apply by placing curve of cannulae into natural curve of nasal passage. Secure with small piece of tape on both cheeks over tubing.



Figure 9.7 nasal cannula

Sources of oxygen

O₂ cylinders contain compressed gas. A flow meter needs to be fitted to regulate flow. A hissing noise can be heard if gas is being delivered.

Take the reading of flow rate from the middle of the ball. Always switch off flow when not in use; ensure indicator ball at bottom of flow meter and not moving.

DO NOT leave anything flammable near to the O₂ supply. **Do not allow smoking near to O₂.** Check adequate O₂ supply is available at least 3 times a day (use a signed log book). If gauge indicating amount left in cylinder is not available, switch on flow and listen to hiss. Replace cylinders as they empty. Ensure cylinders are stored in an upright position on a flat surface and are secure. Cylinder keys should be tied to each cylinder.

Oxygen concentrators may be available. They give >95% oxygen with a flow of 1-8 L/min.

Face masks with seal over nose and mouth for positive pressure ventilation (Figure 9.8)

These are used for either mouth to mask or more commonly bag-mask ventilation. Masks are available in various sizes and the appropriate size to cover the mouth and nose should be chosen.



Self-inflating bags (Figure 9.9)

This is one of the most important pieces of equipment allowing hand ventilation by facemask

Section 9: Emergency skills

without a supply of gas. The two appropriate sizes are **500ml** and **1600ml (the smaller for neonates and the larger in pregnancy)**. These bags have pressure-limiting valves that operate at between 30 and 45cm H₂O. **Test the valve** by placing the mask on a surface and pressing the bag and ensuring the valve opens. It can be overridden if necessary for stiff, poorly compliant lungs.

The bag connects to the patient through a one-way valve to direct exhaled gas to the atmosphere. The other end connects to the oxygen supply and can attach to a reservoir bag which allows high concentrations of oxygen to be delivered (can be up to 98%). Without the reservoir bag concentrations of up to 40% O₂ are delivered. The bag itself is easily dismantled and reassembled. It is important to realize that this system **will operate without an attached oxygen** supply, allowing resuscitation to be initiated before oxygen is available. However, if resuscitation is failing, check that oxygen is being delivered into the bag and patient and that O₂ has not been disconnected.

Always use high flow oxygen and reservoir bag during resuscitation

Clean the system after each patient

Figure 9.9 Self inflating bag and mask

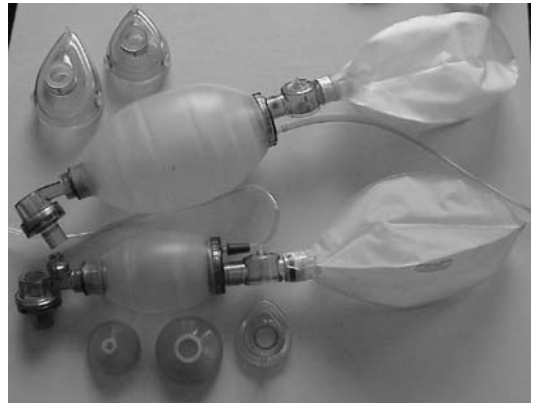

It is essential that the mask is properly sized and correctly placed over the mouth and nose of the patient. (Figure 9.10)

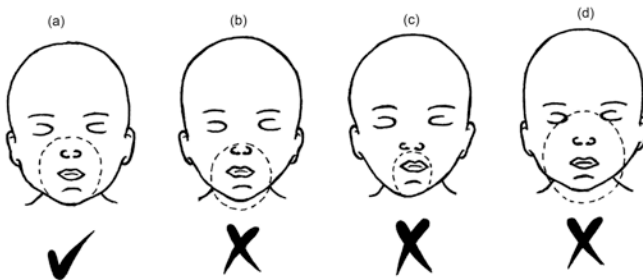

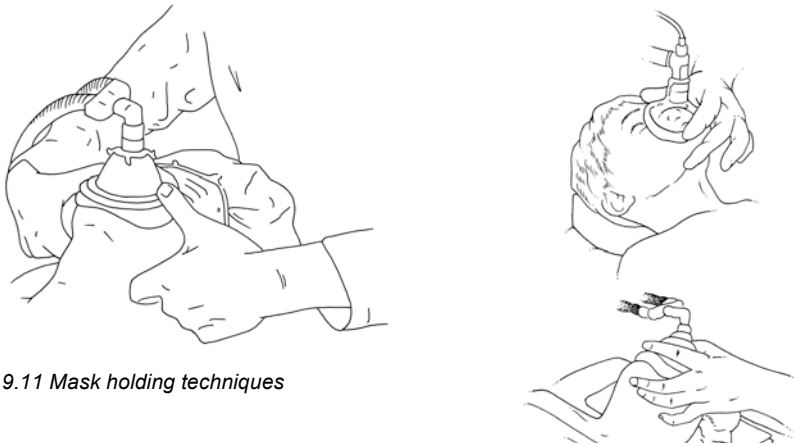
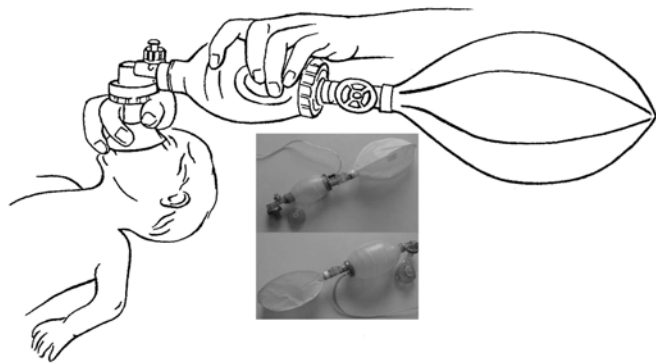

Figure 9.11 Mask holding techniques



If the chest does not rise then the airway is not clear. The usual cause is failure to apply correctly the airway opening techniques. The first step to try is to readjust head tilt / chin lift position and try again. If this is not successful jaw thrust should be tried. Failure of both head tilt / chin lift and jaw thrust should lead to suspicion that a foreign body is causing the obstruction.

Once breathing restarts, replace bag-valve-mask system with simple face-mask and reservoir. Because of the internal valves it is not possible to spontaneously breathe through the bag-valve-mask system.

Longer term respiratory support

Respiratory support is needed when the patient fails to sustain adequate ventilation despite treatment of the respiratory condition. Respiratory failure may result from any of the following:

- respiratory illnesses
- severe shock
- coma
- convulsions eg eclampsia
- meningo-encephalitis
- neuromuscular disorders
- raised intracranial pressure (e.g. from trauma).

Section 9: Emergency skills

Women and girls who are pregnant are more susceptible to respiratory failure. They have reduced immune function, an expanding abdominal mass that impairs lung expansion, and are more prone to gastro-oesophageal reflux and aspiration of gastric contents.

As respiratory failure progresses, it will ultimately lead to cardiorespiratory arrest and death. Thus recognition of the severity of the conditions that lead to respiratory failure, followed by appropriate treatment, will reduce morbidity and mortality.

Signs that indicate the adequacy of breathing include the following:

- intercostal, sub-costal and supra-sternal recession
- respiratory rate
- inspiratory and expiratory noises
- use of accessory muscles
- adequacy of breath sounds and chest expansion
- heart rate
- skin colour
- mental status.

To help to assess the development of respiratory failure, it is necessary to assess changes in the above clinical signs. In the following situations, however, these signs are less useful because there is absent or decreased effort of breathing:

- 1 with fatigue or exhaustion (e.g. after prolonged respiratory effort)
- 2 with loss of cerebral drive from raised intracranial pressure, poisoning or encephalopathy

In these cases, pay more attention to the chest expansion, heart rate, skin colour, mental status and, if available, SaO₂ measurement to measure the arterial oxygen saturation through the skin (SpO₂). Values of SpO₂ of less than 94% in air (at sea level; see Section 46 Appendix for values at high altitude) are abnormal, and would warrant at least initial treatment with additional inspired oxygen. Values of less than 94% when the patient is receiving oxygen are low, but even values of more than 95% in oxygen may be associated with significant hypoventilation. It is essential to remember that, in respiratory failure, normal SaO₂ while receiving additional inspired oxygen is likely to be associated with significant hypoventilation or intra-pulmonary shunting. Measurement of transcutaneous, end-expired or blood carbon dioxide levels will confirm this.

When respiratory fatigue is severe, oxygenation is poor or deteriorating, or carbon dioxide levels are raised, respiratory support should be used, if available.

Respiratory support using **positive pressure ventilation**

- 1 Monitoring of patient status and airway or mask pressures is necessary when undertaking any form of respiratory support (see below).
- 2 Positive airway pressure involves a flow of air or other gas mixture to the patient's airways. This flow may be continuous (as in CPAP) or intermittent (as in IPPV). It may vary with inspiration and expiration (as in BiPAP), or to accommodate the leaks or variable compliance of ventilator tubing, airways or lung units.
- 3 Mask ventilation can be well tolerated.
- 4 In the presence of excess airway secretions or an open mouth, nasal masks and nasal cannula may not produce as effective airway pressures as ventilation with tracheal intubation (or relatively higher pressures may be needed for the same effect).
- 5 The pressures used with masks and cannula may be higher than those used with tracheal intubation, because of the greater potential for air leaks and other volume loss in compliant upper airway structures.
- 6 Endotracheal intubation should be undertaken with rapid sequence drug or gaseous induction, and subsequent analgesia and sedation should be provided.

Section 9: Emergency skills

- 8 Positive pressure ventilation administered through an endotracheal tube must be accompanied by adequate humidity of the inspired gases.
- 9 Oxygen may be administered either using a built-in mixer in the ventilator, or by entraining a supply in the ventilator tubing nearer to the patient.
- 10 Positive pressure ventilators should be able to provide manipulation of either the pressure or volume administered, and the time intervals for inspiration and expiration. There should be alarms for failure to cycle, and for excessive pressure and/or volume administered.

Using a pulse oximeter

1. Switch on and make sure any mains supply is also switched on (this will charge the internal battery, if this exists) - the sensor should light up.
2. Apply the sensor to a relatively translucent part of the body, for example, a finger or toe in pregnancy or to the side of the foot, the palm, thumb or big toe in an infant.
3. Fix the sensor in position:
 - o flexible sensors should be secured with either their own sticky tape, or additional sticky tape that stretches, so arterial pulsations are not impaired
 - o rigid sensors, or 'crocodile clips,' usually attach on a finger and do not need further fixation
4. In situations of bright light, or poor skin perfusion, consider covering the sensor further using, for example, a glove, mitten, or sock.
5. Wait for a short period of time, usually 30 seconds, before reading the measurement of SpO₂ and heart rate from the oximeter, but **only when an adequate arterial pulsation is found**. Most oximeters will have either a bouncing bar display or arterial pulse waveform that is in time with the patients pulse or heart rate.
6. Set the low and high alarm limits for the oxygen saturation (eg 85% and 100%) and pulse rate.
7. Take readings of SpO₂ and pulse rate when a good pulsation is present and the values are relatively stable.

Normal Values for SpO₂

These are usually 95-100% when breathing room air at sea level, and in the presence of good pulse detection. Aim to keep SaO₂ > 94 %.

Low levels whilst breathing additional oxygen usually indicate very serious breathing problems. Normal levels whilst breathing additional oxygen do not mean that ventilation is normal (may have a significant retention of carbon dioxide).

May not get accurate reading if patient shivering, moving, if cold hands or feet, wearing nail varnish or if there is carbon monoxide poisoning, as with for example burns.

Note: skin colour, sickle cell disease and other haemoglobin disorders do not significantly affect the measurement of SaO₂.

Using spacers and nebulisers

Spacers

- Salbutamol can be delivered using spacer device 2-10 puffs ½-4 hourly.
- Take Metered Dose Inhaler (MDI) and shake, place in end of spacer. Press MDI once and ask patient to take 5 normal (effective) breaths, press MDI second time and repeat (NB if breaths ineffective request 10 instead of 5 breaths). Shake MDI after each 2 puffs, as if this is not done only propellant will be delivered.
- Assess benefit after 10 puffs (whole process takes 5-10 minutes dependent on compliance).
- This can be repeated every ½ hour. As symptoms improve increase time between treatments to 1 hourly/2 hourly/4 hourly. Usually need to have 10 puffs 4 hourly for 48 hour then 2 puffs as required
- If patient is requiring O₂ therapy via nasal cannula < 2 litres/minute it can be continued whilst spacer treatment is delivered.

Section 9: Emergency skills

Using a spacer (Figure 9.12)

- When spacer is new, and also between treatments, it should be washed with warm soapy water and left to dry naturally. Drying by any other means will build up static and encourage the drug to stick on the sides of the spacer rather than be delivered to the patient.
- As the patient takes a breath with a commercial spacer, a disk will be seen and heard to move back and forth allowing medication to be delivered.

If there is no proper spacer:

- *A very effective spacer can be made using a plastic IV fluid bottle (see picture) or soft drink bottle.*
- *Failing this an effective aid to inhalation is a paper bag. Express salbutamol into the paper bag and place the bag tightly around the nose and mouth of the patient. Have the patient breathe in and out ten times.*



Nebuliser

- Nebulisers can be driven by oxygen or electrically (must deliver at least 6-9 litres/minute). If severe asthma and possible hypoxia, use O₂ to drive the nebuliser.
- Need regular cleaning and servicing.
- Equipment required
 - Straight O₂ tubing (bubble tubing can be used if this is all that is available)
 - Medication chamber
 - Mask

Attach tubing to medication chamber, add dose of salbutamol to medication chamber and attach mask.

Switch oxygen on at 8 litres/minute (= best flow for dispersment of medication).

Continuous nebulised treatment can be given until symptoms improve. Then treatments can be reduced 1 hourly/2hourly/4 hourly and then as required to control symptoms. Change to MDI and spacer prior to discharge.

- Between treatments medication chamber and mask should be washed with warm soapy water and left to dry naturally.

***If there is no nebuliser:
Use a spacer and give salbutamol continuously***

Tapping the chest for diagnostic tests in pleural effusions or empyema see Section 34

CIRCULATION procedures

Drug and fluid administration IV or IM

General points on safety

- Drug vials once reconstituted do not contain preservatives or antiseptic. Therefore multiple sampling from them is potentially hazardous.
- For neonates, dilute drugs to ensure that volumes can be accurately measured. For example, do not use doses of less than 0.1 mL for a 1-mL syringe.
- Serious errors can occur if the dead space in the hub of the syringe is overlooked during dilution. For example, if the active drug is drawn into a 1-mL syringe up to the 0.1-mL mark, the syringe will contain between 0.19 and 0.23 mL. If the syringe is then filled with diluent to 1 mL, the syringe will contain approximately twice as much drug as was intended. Dilution must involve first half filling the syringe with diluent and then adding active drug by using the distance between two graduations on the syringe. Mix the two by moving the plunger, and then finally add further diluent to the total planned volume of active drug and diluent. For dilutions of more than 10-fold, use a small syringe to inject the active drug, connected by a sterile three-way tap to a larger syringe. Then add diluent to the large syringe to obtain the desired volume.
- Many drugs are equally effective whether given orally or parenterally. **Oral administration is safer and less expensive.** The following antibiotics are as effective given orally as given IV in a neonate who is taking feeds: amoxicillin, ampicillin, chloramphenicol, ciprofloxacin, cotrimoxazole, erythromycin, flucloxacillin, fluconazole, isoniazid, metronidazole, pyrimethamine, rifampicin, sodium fusidate, and trimethoprim.
- If a drug is given down an orogastric or nasogastric tube, a proportion of the drug will remain in the tube unless it is flushed through.
- Rectally administered drugs are less reliably absorbed than drugs given orally. Liquid formulations are better than suppositories in infants.
- When giving IV drugs, do so slowly in all cases. After it has been injected into the line (ideally through a three-way tap), the normal IV infusion rate of the fluid going into the cannula can be used to drive the drug slowly into the patient.
- If there is no background infusion, give sufficient follow-up (flush) of fluid (0.9% saline, sterile water or 5% glucose) to ensure that the drug does not remain in the cannula or T-piece. Give the flush over 2 minutes to avoid a sudden surge of drug (remember the hub).
- Do not mix incompatible fluids IV.
- Adjust the total 24-hour IV fluid intake if large volumes are used to give drugs IV.
- Never allow a surge of a vasoactive drug such as dopamine or adrenaline
- Never put more drug or background IV into the syringe or burette than is needed over a defined period of time.
- Check and chart the rate of infusion, and confirm this by examining the amount left every hour.

Intramuscular injections

- IM injections are unsafe in shock, as they will be poorly absorbed from poorly perfused muscle tissue initially, and then (especially, for example, with opiates) a high dose may be released once recovery of the circulation occurs.
- Alternate between the legs if multiple injections are required.
- Do not give IM injections if a severe bleeding tendency is present.
- It is essential to draw back the plunger to ensure that the needle is not in a vein before injecting potentially dangerous drugs IM (e.g. adrenaline, magnesium sulphate, lidocaine).

Intravenous sampling, injections and infusions

- When sampling from an IV/IA line, clear the dead space first (by three times its volume).
- Blood glucose levels cannot be accurately measured from any line through which a glucose solution is infused, even if many times the dead space has been cleared.
- For blood culture, always use a separate fresh venous 'needle stab' sample.

Section 9: Emergency skills

- Certain infusions, such as glucose > 10%, adrenaline and dopamine, are better given through a central vein. In an emergency, dopamine and epinephrine infusions can be given through a peripheral vein.
- If a continuous infusion is not required, a peripheral cannula can be stopped off with a sterile bung after flushing the drug in with 0.9% saline, sterile water or 5% glucose to clear the dead space (there is no evidence that a heparin lock is needed for a cannula in peripheral veins).
- When giving a drug through an IV cannula, attach the syringe containing the IV drug to the injection port of the cannula and introduce the drug. Once the entire drug has been given, inject 0.5 mL of Ringer-lactate or Hartmann's solution or 0.9% saline into the cannula until the entire drug has entered the circulation and, if an IV infusion is in place, the catheter is filled with the infusion fluid.
- In neonates, frequent flushing with 0.9% saline can result in sodium overload.
- Do not add drugs to any line containing blood or blood products.
- Most IV drugs can be given into an infusion containing 0.9% saline or up to 10% glucose (the exceptions include amphotericin B, phenytoin and erythromycin).
- If only one line is being used for an infusion and more than one drug needs to be given, try to wait 10 minutes between them. If this is not possible, separate by 1 mL of 0.9% saline or sterile water for injections. This is very important with an alkaline drug such as sodium bicarbonate. Always give the flush slowly over at least 2 minutes to ensure that the drug already in the line/vein does not move forward in the patient in a sudden rapid surge (especially if the catheter/vein contains an inotrope or vasoactive drug such as aminophylline, cimetidine, phenytoin or ranitidine, which can cause an arrhythmia).
- When two IV drugs need to be given together and there is only one IV catheter, terminal co-infusion using a T- or Y-connector next to the catheter can be used. It is important to know whether this is safe for the drugs in question.

Care of intravascular cannula

- Never give a drug into an IV cannula that has started to tissue. Some drugs (e.g. those containing calcium) can cause severe scarring. Inspect the cannula tip site before and while injecting any drug IV.
- Infection of the skin at the cannula site is the commonest complication. The infection may lead to thrombophlebitis, which will occlude the vein and result in fever, and may progress to septicaemia. The surrounding skin is red and tender. Remove the cannula immediately to reduce the risk of further spread of the infection. If lymphangitis is present always take a blood culture from a separate vein and start IV or IM antibiotics. IV antibiotic treatment (effective against *Staphylococcus aureus*) should be given. Infection is more likely to become systemic in neonates or in the immunosuppressed.
 - Always place cannula aseptically and keep the site clean.
 - There is no evidence that frequent changes of cannula site or infusion kit are of benefit. However, it is a good idea to change the giving set after blood transfusion or if a line of blood has entered the infusion tubing from the vein and clotted there, as this can act as a site for bacterial colonisation. Otherwise change the lines every 3 or 4 days.
- Air embolism: if air reaches the heart, unlike blood it will stay there, especially if the patient is lying flat. Unless it is immediately aspirated, air in the heart can block the circulation. External jugular and central venous lines are particularly dangerous. There must be a tap or syringe on the catheter at all times, especially during insertion. With peripheral IV cannula, air embolus can occur through the IV giving set, especially when pumps are being used.
- Blood loss can occur if connections become undone.

Minimising IV infusion and IV drugs errors

Extravasation can result in the absence of a vital drug (e.g. morphine infusion for pain).

Steps to reduce errors and their impact

Section 9: Emergency skills

1. Prescribe or change infusion rates as infrequently as possible, ideally once or twice daily.
2. Never have more than one IV infusion line running at the same time unless this is absolutely necessary (e.g. in major trauma or shock, where two lines are needed for volume replacement and also in case one line is lost at a critical time).
3. Record hourly the amount given (from the burette, syringe or infusion bag) and the amount left.
4. Check the infusion site hourly to ensure that extravasation has not occurred.
5. Ensure that flushes are only used when essential, and are given slowly over at least 2 minutes.
6. Ensure that flushes do not overload the patient with sodium.
7. Be particularly careful with potassium solutions given IV (use the enteral route whenever possible).
8. Check and double check the following:
 - Is it the right drug? Check the ampoule as well as the box.
 - Is it the right concentration?
 - Is the shelf life of the drug within the expiry date?
 - Has the drug been constituted and diluted correctly?
 - Is the dose right? (Two people are needed to check the prescription chart.)
 - Is it the correct syringe? (Deal with one patient at a time.)
 - Is the IV line patent?
 - Is a separate flush needed? If so, has the flush been checked?
 - Are sharps (including glass ampoules) disposed of?
 - Has it been signed off as completed (and ideally countersigned)?

Writing a prescription

1. Use block capitals.
2. Use approved names.
3. The dosage should be written in grams (g), milligrams (mg) or micrograms. Always write micrograms in full.
4. Volumes should be written in millilitres (mL).
5. Avoid using decimal places whenever possible. If this is not possible, they should be prefaced by a zero. For example, write 500 mg, not 0.5 g, and if a decimal place is used, write 0.5 mL not .5 mL.
6. Write times using the 24-hour clock.
7. Routes of administration can be abbreviated as follows: IV (intravenous), IM (intramuscular), PO (orally), SC (subcutaneous), NEB (nebuliser), RECT (rectally).
8. 'As required' prescriptions must be specific about how much, how often and for what purpose (indicate the maximum 24-hour dose).
9. Each drug should be signed for individually by a registered doctor.
10. Stop dates for short-course treatments should be recorded when first prescribed.

Note on flushing intravenous cannula and lines

The smaller the syringe used, the greater the pressure exerted on fluid in the line. Therefore avoid using 1-mL syringes to flush a blocked line, as the line may rupture or tissue may be damaged by infiltration.

Care of IV cannula

Secure the cannula when it has been introduced. This may require the splinting of neighbouring joints to limit the movement of the catheter. Keep the overlying skin clean and dry. Fill the cannula with Ringer-lactate or Hartmann's solution or 0.9% saline immediately after the initial insertion and after each injection.

Blood sampling from the IV cannula

Section 9: Emergency skills

If the patient needs blood samples at the time of cannulation it is often possible to take these as the cannula is inserted. Blood can be dripped from the end of the cannula into the appropriate bottles, or a syringe can be used to gently aspirate blood from the cannula. If the cannula has been flushed prior to insertion, the first 0.5–1 mL of blood should be discarded.

Safe IV infusions where no burettes are available

- Mark the infusion bottle with tape for each hour to be given, and label each hour, or
- Empty until only the necessary amount to be given is left in the bottle.

Special sites for IV cannula

External jugular vein (Figure 9.13)

Procedure

- 1 Place patient in a 15–30-degree head-down position (or with padding under the shoulders so that the head hangs lower than the shoulders).
- 2 Turn the head away from the site of puncture.
- 3 Clean the skin over the appropriate side of the neck.
- 4 Identify the external jugular vein, which can be seen passing over the sternocleidomastoid muscle at the junction of its middle and lower thirds.
- 5 Have an assistant place their finger at the lower end of the visible part of the vein just above the clavicle. This stabilises it and compresses it so that it remains distended.
6. If the patient can undertake a valsalva manoeuvre this can help distend the vein
- 7 Puncture the skin and enter the vein pointing in the direction of the clavicle.
- 8 When free flow of blood is obtained, ensure that no air bubbles are present in the tubing, and then attach a giving set.
- 9 Tape the cannula securely in position. One of the most important points is to ensure that the cannula is properly secured in the vein by high-quality fixation. It is easily removed, so use plenty of tape!

Figure 9.13

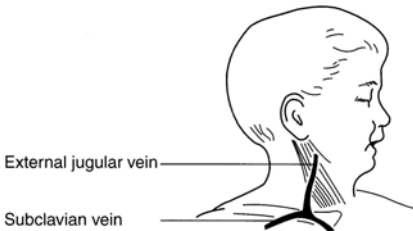

Be aware that there is a higher risk of air embolism than with peripheral venous cannulation.

If infusion through a peripheral vein or external jugular vein is not possible, and it is essential to give IV fluids to keep the patient alive:

- set up an intra-osseous infusion
- or use a central vein
- or perform a venous cut-down.

All of these procedures are described below.

Central venous cannulation

This should not be used routinely, only be performed when IV access is urgent, and only by those who have been trained in the technique (usually an anaesthetist). Remove the cannula from a central vein as soon as possible (i.e. when IV fluids or drugs are no longer essential, or when a peripheral vein can be cannulated successfully).

The aims of central venous cannulation are as follows:

- to obtain venous access when peripheral cannulation is not possible (however, in an emergency, intra- osseous cannulation is faster and easier)
- to monitor central venous pressure
- to obtain prolonged vascular access
- to obtain large-bore vascular access
- to administer certain drugs

Section 9: Emergency skills

- during resuscitation.

Procedure

Several routes are possible, but the most widely used in pregnancy is the internal jugular approach.

The following equipment is needed:

- sterile pack
- sterile Seldinger wires
- cannula: single 16- to 22G cannula
- single, double or triple lumen if available
- syringe and Ringer-lactate or Hartmann's solution or saline
- suture and tape for fixing
- local anaesthetic with fine 25G needles
- Sterilise the skin and maintain sterile technique.

Two insertion techniques are available, namely:

- the same as in peripheral cannulation
- the Seldinger technique (wire)

Ideally an ultrasound probe can help identify the vein and ensure the cannula when inserted is in the correct position in the lumen of the vein.

Seldinger method

- 1 Identify the vein with cannula on syringe (same approach as for peripheral cannulation); there must be good flow.
- 2 Stop, and pass the cannula over the needle.
- 3 Disconnect the syringe.
- 4 Pass the wire through the cannula to three-quarters the length of wire (if there is any resistance, stop, withdraw the wire with needle, and start again).
- 5 Holding the wire firmly, withdraw the needle over the wire.
- 6 Pass the dilator over the wire (it is sometimes necessary to make a small cut at the skin) and, holding the wire firmly, withdraw the dilator.
- 7 Pass the cannula/catheter filled with Ringer-lactate or Hartmann's solution or 0.9% saline over the wire (passage of the cannula should be smooth, meeting no resistance).
- 8 Hold the cannula, and withdraw the wire (gently if it sticks, do not force it).
- 9 Confirm correct placement by aspiration of blood.
- 10 Suture and fix with antiseptic ointment over the entry site.
- 11 Confirm the position with an X-ray.

Internal jugular vein

Use a head-down position as this increases vein distension and reduces the risk of air embolism.

Procedure

- 1 Place the patient in a 30-degree head-down position with lateral tilt if more than 24 weeks pregnant and turn the head to the left-hand side for the right-sided approach, which avoids the lymphatic duct. Place a towel or roll under the shoulders to extend the neck.
- 2 Clean the skin and drape with towels, exposing the neck to the clavicle.
- 3 Identify the apex of the triangle formed by the two heads of the sternocleidomastoid and clavicle, and infiltrate local anaesthetic (if conscious). Alternatively, identify carotid pulsation medial to the sternomastoid at the level of the lower border of the thyroid cartilage, and the vein (usually) just lateral to this. Aim the needle at 30 degrees to the skin and towards the ipsilateral nipple. Estimate the length of catheter from the point of skin entry to the nipple.
- 4 Direct the needle at 30 degrees to the skin, pointing towards the right nipple, and puncture the skin at the apex of the triangle.
- 5 Holding this position, advance the needle, aspirating all the time. If blood 'flashes back', stop advancing and remove the syringe from the needle. (If you do not cannulate the vein, withdraw the needle, but not out of the skin, and advance again slightly more laterally.)
- 6 Feed the Seldinger guide wire through the needle, always having control of one end of the wire.

Section 9: Emergency skills

7 Withdraw the needle over the guide wire and then feed the catheter over the wire into the superior vena cava.

8 Withdraw the wire, aspirate for blood and attach the infusion set. Do not leave the catheter open, as this may lead to an air embolism.

9 Suture the catheter in place and obtain a chest X-ray (if possible) to check for a pneumothorax and the position of the catheter tip, which should be in the superior vena cava (SVC), ideally at the junction of the SVC and the right atrium, but not in the right atrium.

Complications

- arterial puncture
- nerve damage
- pneumothorax
- extravasation-administered fluids/drugs
- septicaemia if the procedure is not sterile or if the cannula is in place for more than 5 days.

Intra-osseous needle insertion

Intra-osseous infusion is a safe, simple and reliable method of giving fluid and drugs in an emergency when venous access is not possible (e.g. in shock).

Standard intraosseous needle insertion

Intra-osseous needles (15- to 18-gauge)

If a purpose-made intra-osseous needle is not available, a number of alternatives can be used, including bone-marrow needles, short lumbar puncture needles or a large-calibre venepuncture needle. For example, a green needle can be used in a neonate. The disadvantage of venepuncture needles is that they may carry a fragment of bone into the marrow. This is not dangerous, but it may block the needle. Also the bevel of these needles is long, and extravasation of fluid is more likely than with a purpose-made intra-osseous needle.

The site for needle insertion is in the middle of the antero-medial surface of the tibia, at the junction of the upper and middle third, to avoid damaging the epiphyseal plate (which is higher in the tibia), 2–3 cm below the tibial tuberosity. An alternative site for needle insertion is the distal femur, 2 cm above the lateral condyle. *Figure 9.14 Site for standard IO needle insertion*

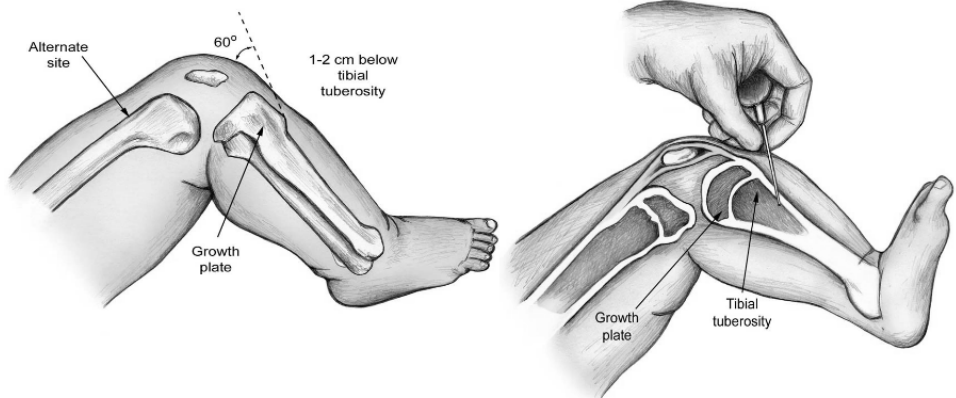

Other equipment needed

This includes the following:

1. a sterile 2-mL syringe containing 1–2% lignocaine to be used whenever the patient is conscious (otherwise the procedure will be very painful)
2. two sterile 5-mL syringes
3. sterile 20- or 50-mL syringes and ideally a three-way tap.

Section 9: Emergency skills

Procedure

- Place padding under the patient's knee so that it is bent at 30° from the straight (180°) position, with the heel resting on the table.
- Locate the correct position (described above and shown in Figure 9.14).
- Wash your hands and put on sterile gloves. (To avoid osteomyelitis, the procedure must involve strict asepsis using an antiseptic solution and sterile gauze to clean the site, with the operator wearing sterile gloves.) Clean the skin over and surrounding the site with an antiseptic solution.
- Infiltrate with lidocaine down to the periosteum if the patient is conscious.
- Ask an assistant to stabilise the proximal tibia by grasping the thigh and knee above and lateral to the cannulation site, with the fingers and thumb wrapped around the knee but not directly behind the insertion site.
- Insert the needle at a 90° angle with the bevel pointing towards the foot. Advance the needle slowly using a gentle but firm twisting or drilling motion.
- Stop advancing the needle when you feel a sudden decrease in resistance or when you can aspirate blood. The needle should now be fixed in the bone and stand up by itself.
- Remove the stylet.
- Aspirate the marrow contents (which look like blood), using the 5-mL syringe, to confirm that the needle is in the marrow cavity and to provide bone marrow/blood for the following tests when appropriate: blood glucose, haemoglobin, group and cross-matching, blood culture and urea and electrolytes.
- Hb, glucose and electrolyte measurements may not be accurate after infusions have been previously given.
- Note that failure to aspirate bone-marrow contents does not mean that the needle is not correctly placed.
- Attach the second 5-mL syringe filled with Ringer-lactate or Hartmann's solution or 0.9% saline. Stabilise the needle and slowly inject 3 mL while palpating the area for any leakage under the skin. If no infiltration is seen, start the infusion.
- Attach the 50-mL syringe, usually containing Ringer-lactate or Hartmann's solution or saline, but compatible blood or 10% glucose can be used if hypoglycaemia is suspected, and push in the infusion fluid in boluses. It is not possible to infuse fluid through the intra-osseous needle using a standard IV giving set. The fluid has to be pushed in under light pressure, and if large volumes are needed (e.g. when giving boluses of fluid to treat shock) then 20-mL or 50-mL syringes should be used.
- Check that the calf does not swell during the injections of fluid.
- Secure IV access as soon as possible.
- When the needle has been removed, cover with a sterile dressing.
- Do not place distal to a major fracture or where there is infection.
- Give prophylactic antibiotics after the immediate emergency has been managed.
- All drugs and fluids that are given IV (including 10% glucose) can be given into the bone marrow, and they will reach the heart and general circulation as fast as if they had been given through a central vein.
- Remove the intra-osseous needle as soon as venous access is available. In any case, it should not be in place for more than 8 hours.

Complications

These include the following:

- dislodgement
- misplacement (penetration through posterior cortex, failure to penetrate cortex), resulting in:
 - haematoma
 - tissue necrosis
 - compartment syndrome
- skin infection
- osteomyelitis
- tibial fracture in babies.

Section 9: Emergency skills

The scalp vein needle as an intra-osseous device

In infants, a green 'butterfly' (scalp vein) needle can be used as an intra-osseous needle with the same precautions as above.

Battery-powered intra-osseous drill device

The EZ-IO drill is a powered device that enables rapid insertion of an intra-osseous needle. Unfortunately the disposable needles are extremely and prohibitively expensive for low resource settings.

Various sizes of needle are available (see Figure 9.15) for different-sized patients.

Figure 9.15. EZ-IO power drill and needles

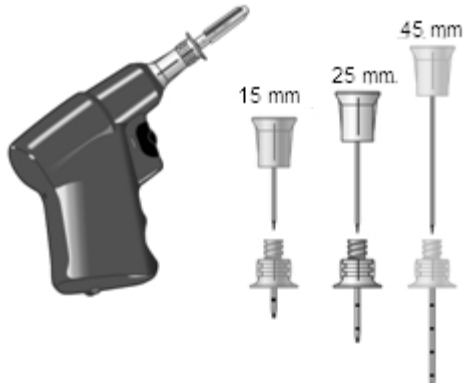

The landmarks are as before, using the upper end of the tibia. In pregnancy the upper outer aspect of the humerus is a better site.

Figure 9.16. Site for EZ-IO needle in the proximal humerus in pregnancy



The procedure is less painful for the conscious patient due to its rapidity, the drilling effect and the sharpness of the needles. The EZ-IO needles are available in two sizes, for patients under 40 kg and over 40 kg.

The procedure for insertion is as follows:

1. Take universal precautions for sterile procedure.
2. Clean the site.
3. Choose an appropriate size of needle and attach it to the drill. It will fix magnetically.
4. Remove the safety cap from the needle.
5. If the patient is conscious, control their movement during insertion.

Section 9: Emergency skills

6. Hold the drill and needle at 90° to the skin surface and push through the skin without drilling, until bone is felt. Ensure that at least 5 mm of the needle is visible at this point.
7. Squeeze the drill button and drill continuously, applying gentle steady downward pressure until there is sudden loss of resistance – there is a palpable 'give' as the needle breaches the cortex. Release the trigger and stop insertion at this point.
 - a. If the driver stalls and will not penetrate the bone you may be applying too much downward pressure.
 - b. If the driver fails (this is rare) remove it, grasp the needle kit by hand and twist it into the bone marrow.
8. Remove the drill and unscrew the trochar.
9. Aspirate the bone marrow if possible directly from the needle.
10. Attach the pre-prepared connection tube containing sterile Ringer-lactate or Hartmann's solution or 0.9% saline before any infusion is given. Do not attach a syringe directly to the EZ-IO catheter hub except when drawing blood with the needle set stabilised by hand (sterile).
11. Proceed with the required therapy. It should be noted that rapid infusion of fluid may be painful for the conscious patient.
12. Apply a sterile dressing.
13. When removing the catheter, attach a Luer lock syringe, and continuously rotate it clockwise while slowly and gently applying traction to the catheter. Do not rock or bend the catheter during removal.
14. Do not leave the catheter in place for more than 24 hours.

Figure 9.17. EZ-IO needle in place, with stylet removed.

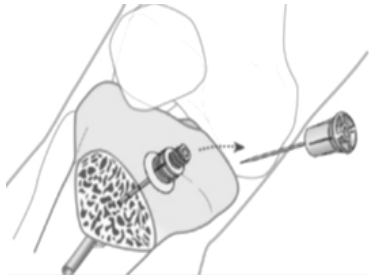

Cut-down venous cannulation

Indication

Continuous IV access is needed where percutaneous attempts have failed. In the emergency situation, intra-osseous access is faster and easier. Cut-down is less appropriate if speed is essential.

Preparation of kit

The following equipment is needed:

- skin prep (iodine, alcohol)
- scalpel
- suture
- IV cannula
- local anaesthetic
- curved artery forceps
- syringe and hypodermic needle
- sterile drapes.

Procedure

Long saphenous vein:

Section 9: Emergency skills

- Immobilise the lower leg and clean the skin, as described above. Identify the long saphenous vein, which lies 1-2 finger breadths (in pregnancy) superior and anterior to the medial malleolus.
- Clean the skin and drape with sterile towels.
- Infiltrate the skin with 1% lignocaine using a fine 24- to 25G needle, and make an incision through the skin perpendicular to the long axis of the vein. Bluntly dissect the subcutaneous tissue with haemostat forceps.
- Identify and free a 1–2 cm section of vein. Pass a proximal and distal ligature.
- Tie off * the distal end of the vein, keeping the ties as long as possible for traction.
- Make a small hole in the upper part of the exposed vein, gently dilate the opening with the tip of a closed haemostat, and insert the cannula (without the needle/trocar in it) into this, while holding the distal tie to stabilise the position of the vein.
- Secure the cannula in place with the upper ligature.
- Attach a syringe filled with Ringer-lactate or Hartmann's solution or saline and ensure that the fluid flows freely up the vein. If it does not, check that the cannula is in the vein or try withdrawing it slightly to improve the flow.
- Tie the distal ligature* around the catheter, and then close the skin incision with interrupted sutures.
- Place antiseptic ointment (e.g. iodine) over the wound, and suture or tape the catheter to the skin (ensure that local anaesthetic is used at the suture site if the child is conscious). Cover with sterile dressing.

*** It is also possible to dispense with the proximal and distal ligatures and simply penetrate the vein directly with a plastic over-the-needle cannula as you would if penetrating the skin externally. Once in the vein, remove the inner needle and secure in position.**

Complications

These include the following:

- haemorrhage or haematoma
- perforation of the posterior wall of the vein
- nerve transection
- phlebitis
- venous thrombosis.

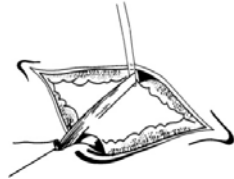

Figure 9.18. Cut-down incision showing vein and position of cut-down on long saphenous vein at ankle.



Defibrillation

In cardiac arrest when the rhythm is ventricular fibrillation (VF) or pulseless ventricular tachycardia (VT).

In any patient who is not in extremis, anaesthesia/sedation must be given before the DC shock is administered.

Safety

A defibrillator delivers enough current to cause cardiac arrest. The user must ensure that other rescuers are not in physical contact with the patient (or the trolley) at the moment when the shock is delivered. The defibrillator should only be charged when the paddles are either in contact with the child or replaced properly in their storage positions. Oxygen must be discontinued and be moved right away from the patient.

Procedure

Section 9: Emergency skills

Basic life support should be interrupted for the shortest possible time (see steps 5 to 9 below).

- 1 Apply gel pads or electrode gel.
- 2 Select the correct paddles
- 3 Select the energy required.
- 4 Place the electrodes on the pads of gel, and apply firm pressure.
- 5 Press the charge button.
- 6 Wait until the defibrillator is charged.
- 7 Shout 'Stand back!'
- 8 Check that all of the other rescuers are standing clear.
- 9 Deliver the shock.

Correct paddle placement

The usual placement is antero-lateral. One paddle is put over the cardiac apex in the mid-axillary line, and the other is placed just to the right of the sternum, immediately below the clavicle.

Good paddle contact

Gel pads or electrode gel should always be used (if the latter is used, care should be taken not to join the two areas of application). Firm pressure should be applied to the paddles.

Correct energy selection

The recommended level in VF or pulseless VT cardiac arrest is 4 joules/kg.

Automatic external defibrillators (AEDs)

Attach AED pads

Expose the chest and place one adhesive defibrillator pad on the patient's chest to the right of the sternum below the right clavicle, and one in the mid-axillary line, taking care to avoid breast tissue. Keep the axillary electrode vertical to maximise efficiency.

If a shock is indicated, most AED devices will do this automatically, but some will ask the operator to deliver the shock by pressing a button. Immediately after the shock, resume compressions for 2 minutes, after which there will be a further prompt for a rhythm analysis.

If defibrillation is **not** indicated, CPR should be continued for 2 minutes, at which stage the AED will prompt further analysis of the rhythm.

Section 9: Emergency skills

Figure 9.18 Algorithm for automatic external defibrillator (AED) use

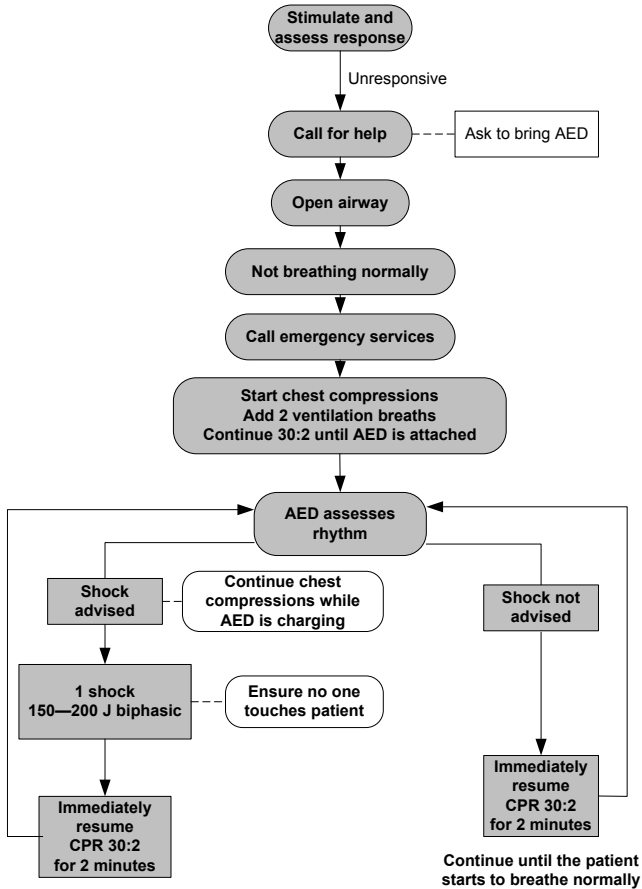

Insertion of an orogastric or nasogastric tube

The nasogastric tube is used to feed any patient who is unable to take food by mouth.

Preparation of kit

The following equipment is needed:

1. nasogastric tube
2. lubricant
3. pH indicator paper or litmus paper
4. syringe
5. stethoscope
6. adhesive tape.

Procedure

Section 9: Emergency skills

- Place the patient supine with their head in the 'sniffing' position.
- Measure the length of the tube from the nose via the earlobe to the mid-point between the xiphoid and the umbilicus. Mark the tube at this point with indelible pen.
- Feed the tube lubricated with KY Jelly or saline through either the nose or the mouth directly backwards. (The neonate is a nose breather, and therefore if there is respiratory distress the oral route may be preferred.) Try to advance the tube as the patient swallows. If a baby has respiratory distress, a gastric tube is best passed through the mouth.
- Check the position of the tube by very gently aspirating 0.2–0.5 mL of stomach contents using a small (2- or 5-mL) syringe (larger ones can damage the gastric mucosa) and checking the change in the pH indicator paper (the pH should be 5.5 or less, or the litmus paper should change colour from blue to pink), or flush the tube with 2–3 mL of air (only 1 mL in the neonate) and listen over the stomach area with the stethoscope. If in doubt, X-ray the chest and/or abdomen. (Note that the acidity of the gastric fluid may be reduced in preterm infants.)
- If there is any doubt about the location of the tube, withdraw it and start again. Withdraw immediately if the patient starts coughing, as the tube may then be in the airway.
- Secure the tube by taping it to the cheek, and record the length of tube outside the nose or mouth.
- When the tube is in place, fix a 50-mL syringe (without the plunger) to the end of the tube, and pour food or fluid into the syringe, allowing it to flow by gravity.
The nasal route is more comfortable and secure, but if an infant has respiratory distress or is receiving CPAP, an orogastric tube is best (if passed through the nose the tube increases upper airway resistance).

Never pass a nasogastric tube in a head-injured patient. An orogastric tube is safe. If there is a base-of-skull fracture, a nasal tube could be pushed into brain tissue.

Figure 9.20. Inserting a nasogastric tube

(a) The distance from the nose to the ear and then to the epigastrium is measured. (b) The tube is then inserted to the measured distance.

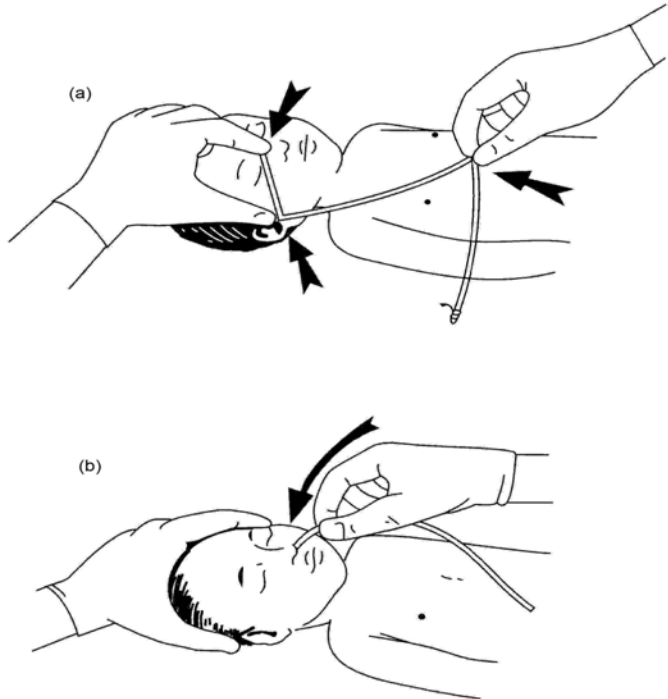

Section 9: Emergency skills

Incision and drainage of abscess

Indications

- The collection of localised infection.
- If there is uncertainty whether a hot red mass is an abscess, aspirate for pus before proceeding to incision and drainage.
- Multiple/recurrent abscesses may be associated with HIV, TB, malnutrition, diabetes mellitus, anaemia or foreign bodies.

The following equipment is needed:

- skin preparation materials
- scalpel
- microbiology swab
- curette
- sterile gauze.

Procedure

- 1 If the patient is systemically unwell, take blood cultures (before giving antibiotics).
- 2 Antibiotics are only indicated if the patient is systemically unwell or if spreading cellulitis is present.
- 3 Use general anaesthesia for certain sites (perianal, breast, cervical, etc.). Regional blocks may be used for limbs (Note that local infiltration produces poor anaesthesia in inflamed tissue.)
- 4 Clean the skin.
- 5 Incise over the most superficial tender point in the direction of skin creases. Take a sample of pus for culture and staining, including the Ziehl–Neelsen stain if indicated. The commonest error is to make the incision too small.
- 6 Insert a curette spoon or finger to break down any loculi. Send a sample of the wall of the abscess for TB if indicated.
- 7 Irrigate the cavity with 0.9% saline to flush out necrotic material.
- 8 If a large cavity exists, loosely pack it with sterile gauze. For a small cavity place a ‘wick’ (e.g. a piece of rolled gauze) into the wound, forming a track. Cover the wound loosely with absorbent dressing. Change the gauze packing after 24 hours, giving analgesia beforehand if needed. Remove the wick after 48 hours.
- 9 As the cavity discharges pus it should heal from a depth to superficially through the open skin incision.

Abdominal paracentesis see Section 42

Lumbar puncture

The following equipment is needed:

- iodine
- sterile gloves
- sterile dressings pack
- spinal needle with stylet
- collodion
- small adhesive dressing
- local anaesthetic
- sedation (in some cases).

Indications

- As part of septic screen in case meningitis is present.
- For investigating the possible cause of seizures.

Contraindications

- Signs of raised intracranial pressure, such as deep coma (P or U on the AVPU scale), unequal pupils, rigid posture or paralysis in any of the limbs or the trunk, or irregular breathing.
- Skin infection in the area through which the needle will have to pass

Section 9: Emergency skills

- Significant bleeding disorder.

If contraindications are present, the potential value of the information gained from a lumbar puncture should be carefully weighed against the risk of the procedure. If in doubt, it might be better to start treatment for suspected meningitis, and delay performing a lumbar puncture.

Precautions

- Do not perform a lumbar puncture in the very sick patient (it may precipitate shock).
- Excessive neck flexion when positioning can lead to acute respiratory deterioration.
- If a spinal needle is unavailable and a normal (non- stylet) needle is used, the needle bore may become blocked with skin on insertion and therefore obstruct flow. There is also the risk of tissue implantation leading to a dermoid cyst.

Procedure

There are two possible positions:

- the patient lying down on the left side
- the patient in the sitting position

Figure 9.21 Supporting a patient lying on her left side for a lumbar puncture. Note that the spine is curved to open up the spaces between the vertebrae.



When the patient is lying on their side a hard surface should be used. Place the patient on their side so that the vertebral column is parallel to this surface and the transverse axis of the back is vertical (see Figure 9.20).

Section 9: Emergency skills

It is helpful to have an experienced assistant present to hold the patient. Flex the spine maximally, but avoid excessive neck flexion. Make sure that the airway is not obstructed and the patient can breathe normally.

Figure 9.22 The patient in a sitting position for a lumbar puncture.



Prepare the site

- Use an aseptic technique. Scrub your hands and wear sterile gloves.
- Prepare the skin around the site with an antiseptic solution.
- Sterile towels may be used.
- In older children who are alert, give a local anaesthetic (1% lignocaine) infiltrated in the skin and subcutaneous tissue over the site.

Identify site of insertion

Locate the space between the third and fourth lumbar vertebrae or between the fourth and fifth lumbar vertebrae. (The third lumbar vertebra is at the junction of the line between the iliac crests and the vertebral column.)

Use an LP needle with a stylet (16-18 gauge; if these are not available, routine hypodermic needles may be used). Insert the needle into the middle of the inter-vertebral space and aim the needle towards the umbilicus.

Advance the needle slowly. The needle will pass easily until it encounters the ligament between the vertebral processes. More pressure is needed to penetrate this ligament, and less resistance is felt as the dura is penetrated.

Stop advancing when a 'give' or puncture sensation is felt on entering the subarachnoid space. Frequent stylet withdrawals during the procedure should be undertaken to see if the CSF flows, indicating that the subarachnoid space has been successfully entered. The subarachnoid space can be easily over-penetrated by mistake. Over-penetration leads to puncturing of the anterior vertebral venous plexus and a bloody sample, so that CSF microscopy is less informative or perhaps impossible. The needle should be withdrawn and the procedure repeated in another disc space.

Withdraw the stylet. Obtain a sample of 1 - 2 mL of CSF and place it in sterile containers, allowing at least six drops of CSF to drip into each sample container.

Replace the stylet.

Withdraw the needle and stylet completely and apply pressure to the site for a few seconds. Put a sterile dressing over the needle puncture site, and cover the whole site with adhesive dressing.

Send samples for the following:

- 1 microscopy, cell type and counts, Gram and Ziehl-Neelson staining, culture and sensitivity (including for TB) and virology.
- 2 biochemistry (glucose, protein)

Urethral Catheterisation see Section 41

Section 10: WHO safe childbirth checklist
Section 10: The WHO Safe Childbirth Checklist

Checklist item	Qualifying caption	
<i>On admission of the mother to the birth facility</i>		
Does the mother need referral?	<input type="checkbox"/> Yes	According to the facility's criteria
	<input type="checkbox"/> No	
Partograph started?	<input type="checkbox"/> Yes	Start plotting when cervix is ≥ 4 cm, then cervix should dilate ≥ 1 cm/hour. Every 30 minutes, plot heart rate, contractions and fetal heart rate. Every 2 hours, plot temperature. Every 4 hours, plot blood pressure
	<input type="checkbox"/> No, will start when ≥ 4 cm	
Does the mother need to start antibiotics?	<input type="checkbox"/> Yes, given	Give if temperature is $\geq 38^{\circ}\text{C}$, or if there is a foul-smelling vaginal discharge, rupture of membranes longer than 18 hours, or labour longer than 24 hours
	<input type="checkbox"/> No	
Does the mother need to start magnesium sulphate?	<input type="checkbox"/> Yes, given	Give if (1) diastolic blood pressure is ≥ 110 mmHg and 3+ proteinuria, or (2) diastolic blood pressure is ≥ 90 mmHg and 2+ proteinuria, and any of the following: severe headache, visual disturbance or epigastric pain
	<input type="checkbox"/> No	
Does the mother need to start antiretroviral medicine?	<input type="checkbox"/> Yes, given	Give if the mother is HIV positive and in labour
	<input type="checkbox"/> No	
<input type="checkbox"/> Supplies are available for cleaning hands and wearing gloves for each vaginal examination		
<input type="checkbox"/> Birth companion encouraged to be present at birth		
<input type="checkbox"/> Confirm that the mother and/or companion will call for help during labour if the mother has a danger sign		Call for help if the mother has bleeding, severe abdominal pain, severe headache, visual disturbance, urge to push, or difficulty emptying bladder

Section 10: WHO safe childbirth checklist

Checklist item		Qualifying caption
<i>Just before pushing (or before Caesarean section)</i>		
Does the mother need to start antibiotics?	<input type="checkbox"/> Yes, given	Give if temperature is $\geq 38^{\circ}\text{C}$, or if there is a foul-smelling vaginal discharge, rupture of membranes longer than 18 hours now, labour longer than 24 hours, <i>or</i> Caesarean section
	<input type="checkbox"/> No	
Does the mother need to start magnesium sulphate?	<input type="checkbox"/> Yes, given	Give if (1) diastolic blood pressure is ≥ 110 mmHg and 3+ proteinuria, <i>or</i> (2) diastolic blood pressure is ≥ 90 mmHg and 2+ proteinuria, and any of the following: severe headache, visual disturbance <i>or</i> epigastric pain
	<input type="checkbox"/> No	
Are essential supplies at the bedside for the mother?	<input type="checkbox"/> Gloves	Prepare to care for the mother immediately after birth: (1) Exclude the possibility of a second baby, (2) Give oxytocin within 1 minute, (3) Use controlled cord traction to deliver the placenta, (4) Massage the uterus after the placenta has been delivered
	<input type="checkbox"/> Soap and clean water	
	<input type="checkbox"/> Oxytocin 10IU in syringe	
Are essential supplies at the bedside for the baby?	<input type="checkbox"/> Clean towel	Prepare to care for the baby immediately after birth: (1) Dry the baby and keep them warm, (2) If the baby is not breathing, stimulate and clear the airway, (3) If they are still not breathing, cut the cord, ventilate with bag and mask, and (4) shout for help
	<input type="checkbox"/> Sterile blade to cut cord	
	<input type="checkbox"/> Suction device	
	<input type="checkbox"/> Bag and mask	

Section 10: WHO safe childbirth checklist

Checklist item	Qualifying caption	
<input type="checkbox"/> Has an assistant been identified and informed to be ready to help at birth if needed?		
<i>Soon after birth (within 1 hour)</i>		
Is the mother bleeding too much?	<input type="checkbox"/> Yes, shout for help	If blood loss is ≥ 500 mL, or if blood loss is ≥ 250 mL and the mother is severely anaemic, massage the uterus, consider additional uterotonic drugs, start an intravenous line, and treat the cause
	<input type="checkbox"/> No	
Does the mother need to start antibiotics?	<input type="checkbox"/> Yes, given	Give antibiotics if the placenta is manually removed, or if the temperature is $\geq 38^{\circ}\text{C}$ and any of the following are present: foul-smelling vaginal discharge, lower abdominal tenderness, rupture of membranes longer than 18 hours at time of delivery, or labour longer than 24 hours at time of delivery
	<input type="checkbox"/> No	
Does the mother need to start magnesium sulphate?	<input type="checkbox"/> Yes, given	Give if (1) diastolic blood pressure is ≥ 110 mmHg and 3+ proteinuria, or (2) diastolic blood pressure is ≥ 90 mmHg and 2+ proteinuria, and any of the following: severe headache, visual disturbance or epigastric pain
	<input type="checkbox"/> No	
Does the baby need a referral?	<input type="checkbox"/> Yes,	According to the healthcare facility's criteria
	<input type="checkbox"/> No	
Does the baby need to start antibiotics?	<input type="checkbox"/> Yes, given	Give these if antibiotics were given to the mother, or if the baby has any of the following: breathing too fast (> 60 breaths/minute) or too slow (< 30 breaths/minute), chest in-drawing, grunting, convulsions, no movement on stimulation, or too cold (temperature $< 35^{\circ}\text{C}$ and not rising after warming) or too hot (temperature $> 38^{\circ}\text{C}$)
	<input type="checkbox"/> No	
<input type="checkbox"/> Does the baby need special care and monitoring?		Recommended if more than 1 month early, birth weight < 2500 grams, needs antibiotics, or required resuscitation

Section 10: WHO safe childbirth checklist

Checklist item		Qualifying caption
Does the baby need to start an antiretroviral drug?	<input type="checkbox"/> Yes, given	Give antiretroviral drug if the mother is HIV positive
	<input type="checkbox"/> No	
<input type="checkbox"/> Started breastfeeding and skin-to-skin contact (if mother and baby are well)?		
<input type="checkbox"/> Confirm that the mother or companion will call for help if:		The mother has bleeding, severe abdominal pain, severe headache, visual disturbance, breathing difficulty, fever/chills, or difficulty emptying bladder
		The baby has fast breathing or difficulty breathing, fever or is unusually cold, stops feeding well, is less active than normal, or the whole body becomes yellow
<i>Before discharge</i>		
Is the mother's bleeding	<input type="checkbox"/> Yes	
	<input type="checkbox"/> No, treat and delay	
Does the mother need to start antibiotics?	<input type="checkbox"/> Yes, given	Give if the temperature is > 38°C and any of the following: chills, foul-smelling vaginal discharge, or lower abdominal tenderness
	<input type="checkbox"/> No	
Does the baby need to start antibiotics?	<input type="checkbox"/> Yes, give antibiotics, delay discharge, and give special care or refer	Give if the baby is breathing too fast (> 60 breaths/minute) or too slow (< 30 breaths/minute), or if there is chest in-drawing, grunting, convulsions, no movement on stimulation, too cold (temperature < 35°C and not rising after warming) or too hot (temperature > 38°C), has stopped breastfeeding well, or there is umbilical redness extending to the skin or draining pus
	<input type="checkbox"/> No	
Is the baby feeding well?	<input type="checkbox"/> Yes	
	<input type="checkbox"/> No	Help and delay

Section 10: WHO safe childbirth checklist

Checklist item		Qualifying caption
<input type="checkbox"/> Family planning options discussed and offered to mother		
<input type="checkbox"/> Confirm that the mother or companion will call for help after discharge if:		The mother has bleeding, severe abdominal pain, severe headache, visual disturbance, breathing difficulty, fever/chills, <i>or</i> difficulty emptying bladder
		The baby has fast breathing or difficulty breathing, fever <i>or</i> is unusually cold, stops feeding well, is less active than normal, <i>or</i> the whole body becomes yellow
<input type="checkbox"/> Follow-up arranged for mother and baby		

Section 11: Symptoms and signs of emergencies in pregnancy

Abdominal pain in early pregnancy

Abdominal pain due to obstetric or gynaecological causes

Presenting symptoms	Clinical signs on presentation	Investigations	Diagnosis	Treatment
Lower abdominal pain, intermittent and very sharp Vomiting	Mass in lower abdomen or on vaginal examination Warning: when performing a vaginal examination in a patient with abdominal pain who may be pregnant, consider ectopic pregnancy	Pregnancy test is helpful in early pregnancy	Ovarian cyst which may become twisted (consider torsion if there is severe pain and vomiting)	Consider surgery if this is safe and available
Lower abdominal pain Signs of early pregnancy: tiredness, nausea and/or vomiting (especially in the early morning), breast swelling, increased urinary frequency Light vaginal bleeding (takes > 5 minutes for clean pad to be soaked) Shoulder pain Fainting if ruptured Amenorrhoea with perhaps only one missed period Rectal pain	Shock if ruptured (pale, sweating, fast heart rate > 100 beats/minute), weak pulse volume, low blood pressure (systolic < 90 mmHg), drowsy, irritable, unconscious) Caution must be exercised when performing a vaginal examination if an ectopic pregnancy is possible, because of the risk of rupture during and due to the examination Vaginal examination may show signs of early pregnancy (soft uterus), closed cervix, light bleeding, tender mass in one fornix, tenderness with cervical movement	Pregnancy test positive Ultrasound	Ectopic pregnancy which may be ruptured	Prepare operating theatre for immediate salpingectomy Treat shock Group and cross-match 4–6 units of blood

Section 11: Symptoms and signs of emergencies in pregnancy

Presenting symptoms	Clinical signs on presentation	Investigations	Diagnosis	Treatment
<p>Pelvic pain</p> <p>Pain on intercourse</p> <p>Vaginal discharge</p>	<p>Fever</p> <p>Tender lower abdomen</p> <p>Tender on vaginal examination but do not undertake this if ectopic pregnancy is a possibility</p>	<p>Raised white blood cell count</p> <p>Ultrasound</p> <p>High vaginal swab for microscopy, culture and sensitivity</p>	<p>Pelvic inflammatory disease</p>	<p>Antibiotics IV if severe: metronidazole plus: <i>either</i> a macrolide such as erythromycin or azithromycin or doxycycline or ofloxacin</p>
<p>Lower abdominal pain</p> <p>History of termination of pregnancy attempted (may not be given even if this has occurred)</p> <p>Vaginal bleeding</p>	<p>Fever</p> <p>Vaginal bleeding (moderate to heavy)</p> <p>Purulent vaginal discharge</p> <p>If very severe, peritonitis (see above)</p>	<p>White blood cell count</p> <p>Haemoglobin</p> <p>Blood culture</p>	<p>Septic abortion</p>	<p>Treat shock</p> <p>IV antibiotics</p> <p>May need an intervention such as manual vacuum aspiration to remove infected products of conception, or even hysterectomy (after stabilisation)</p>

Abdominal pain in late pregnancy

Abdominal pain due to obstetric causes

Symptoms	Signs	Diagnosis	Investigatio	Treatment
<p>Intermittent lower abdominal pain</p> <p>Vaginal fluid loss before 37 weeks' gestation suggesting premature rupture of membranes</p> <p>Light vaginal bleeding*</p>	<p>Palpable uterine contractions</p> <p>Cervical dilatation</p> <p>Check for prolapsed cord if there is rupture of membranes</p>	Possible preterm labour	Partogram	<p>Give two 12mg doses of betamethasone or dexamethasone IM 12hours apart</p> <p>Tocolysis only to give time for the steroids to work. Nifedipine 20 mg orally, followed by 20mg orally after 30 minutes. If contractions persist, therapy can be continued with 20mg orally every 3–8 hours for 48–72 hours, with a maximum dose of 160mg/24 hours</p>
<p>Intermittent lower abdominal pain</p> <p>Vaginal fluid loss after 37 weeks' gestation suggesting rupture of membranes</p> <p>Light vaginal bleeding</p>	<p>Palpable uterine contractions</p> <p>Cervical dilatation and effacement</p> <p>Check for prolapsed cord if there is rupture of membranes</p>	Term labour	Partogram	See Textbook

Symptoms	Signs	Diagnosis	Investigations	Treatment
<p>Lower abdominal pain, intermittent and very sharp</p>	<p>Mass in lower abdomen or on vaginal examination. Difficult to feel in pregnancy per abdomen or per vagina as the uterus is enlarged</p>	Ovarian cyst which may become twisted (this is very rare in late pregnancy)	Ultrasound	May need laparotomy

Section 11: Symptoms and signs of emergencies in pregnancy

<p>Severe constant abdominal pain</p> <p>Light or heavy vaginal bleeding*</p> <p>Fetal movements stop</p>	<p>Shock</p> <p>Tense and very tender uterus on abdominal examination</p> <p>Fetal distress or absent fetal heart</p>	<p>Placental abruption</p>	<p>Ultrasound</p>	<p>Call for surgical and anaesthetic help</p> <p>Left lateral tilt or recovery position</p> <p>IV fluid boluses for shock</p> <p>Cross-match 4 units of blood and freeze-dried plasma if available</p> <p>Deliver fetus as soon as possible if alive</p>
<p>There is a change (usually during labour) from intermittent labour contractions to a constant pain which may become less after rupture has occurred</p> <p>Sometimes there is an oxytocin drip in place</p> <p>Vaginal bleeding which may be light or heavy</p> <p>History of a previous Caesarean section or other operation on the uterus</p>	<p>Shock</p> <p>Abdominal distension</p> <p>Tender over the uterus, with more easily palpated fetal parts</p> <p>Absent fetal movements and heart sounds</p>	<p>Ruptured uterus</p>	<p>Ultrasound may help diagnosis, but must not delay laparotomy</p>	<p>Call for surgical and anaesthetic help</p> <p>Treat shock if present</p> <p>Cross-match 4 units of blood and freeze-dried plasma if available</p> <p>Prepare theatre for laparotomy after patient is stable</p>
<p>Foul-smelling watery vaginal discharge</p> <p>Lower abdominal pain</p> <p>Premature labour or premature rupture of membranes</p> <p>Light vaginal bleeding</p>	<p>Fever</p> <p>Tender over the lower abdomen and uterus</p> <p>Possible fetal distress</p>	<p>Chorio-annionitis</p>	<p>White blood cell count</p> <p>Blood culture</p> <p>Discharge for microscopy, culture and sensitivity</p>	<p>IV antibiotics before urgent delivery, whatever the gestational age:</p> <p>Ampicillin 2g IV every 6 hours</p> <p><i>plus</i> gentamicin 80mg IV/ IM every 8 hours or 5 mg/ kg body weight IV/IM once every 24 hours</p> <p><i>plus</i> metronidazole 500 mg IV every 8 hours</p>

Section 11: Symptoms and signs of emergencies in pregnancy

Purulent, foul-smelling lochia Lower abdominal pain Light vaginal bleeding	Fever Tender uterus Shock	Endometritis after birth (puerperal sepsis)	Raised white blood cell count Blood culture Lochia for microscopy, culture and sensitivity	Treat shock IV antibiotics: Ampicillin 2g IV every 6 hours <i>plus</i> gentamicin 80 mg IV/IM every 8 hours or 5mg/kg body weight IV/IM once every 24 hours <i>plus</i> metronidazole 500 mg IV every 8 hours
--	---------------------------------	--	--	---

Abdominal pain due to obstetric causes

Symptoms	Signs	Diagnosis	Investigations	Treatment
Lower abdominal pain Rare in late pregnancy, but may present postnatally	Swinging fever Swelling in adnexa or pouch of Douglas Tender uterus Ultrasound	Pelvic abscess	Raised white blood cell count Blood culture Pus for microscopy, culture and sensitivity	IV antibiotics: Ampicillin 2g IV every 6 hours <i>plus</i> gentamicin 80mg IV/ IM every 8 hours or 5 mg/ kg body weight IV/IM once every 24 hours <i>plus</i> metronidazole 500 mg IV every 8 hours Surgical drainage
Upper abdominal pain	Headache Visual disturbance Oedema	Severe pre-eclampsia with impending eclampsia	Raised blood pressure Protein in urine $\geq 1+$	Magnesium sulphate Urgent delivery of fetus

* Light bleeding is defined as taking longer than 5 minutes for a clean pad or cloth to become soaked. Heavy bleeding is defined as taking less than 5 minutes for a clean pad or cloth to become soaked.

Section 11: Symptoms and signs of emergencies in pregnancy

Abdominal pain during pregnancy due to coincidental causes				
Symptoms	Signs	Diagnosis	Investigations	Treatment
Lower abdominal pain Nausea and/or vomiting Anorexia	Low-grade fever (> 37.5°C) Tenderness of the right iliac fossa, sometimes with rebound Tender in the right iliac fossa on rectal examination	Appendicitis	White blood cell count elevated Ultrasound if skilled	Appendicectomy
Severe abdominal pain Vomiting	High fever Abdominal distension Rigid abdomen Absent bowel sounds Shock (see above for signs)	Peritonitis		Treat shock Consider immediate laparotomy: call surgeon and anaesthetist and prepare operating theatre IV antibiotics: Ampicillin 2g IV every 6 hours <i>plus</i> gentamicin 80mg IV/IM every 8 hours or 5mg/kg body weight IV/ IM once every 24 hours <i>plus</i> metronidazole 500mg IV every 8 hours Nasogastric tube on open drainage Immediate laparotomy in operating theatre
Pain on passing urine Increased frequency of passing urine Nocturia	Rarely fever	Cystitis	Microscope urine Stick tests for infection (if available) Urine culture and sensitivity if available	Oral antibiotics
Pain in the lower abdomen or loin Nausea and/or vomiting Increased frequency of passing urine	High fever Tenderness in one of the loins over the kidney Normal bowel sounds	Pyelonephritis	Microscope urine Stick tests for infection (if available) Urine culture and sensitivity if possible	Ampicillin 2g IV every 6 hours <i>plus</i> gentamicin 80mg IV/IM every 8 hours or 5mg/kg body weight IV/ IM once every 24 hours <i>plus</i> metronidazole 500mg IV every 8 hours

Section 11: Symptoms and signs of emergencies in pregnancy

Vaginal bleeding in early pregnancy

In all cases a pregnancy test must be performed

Vaginal bleeding in early pregnancy			
Symptoms	Signs	Diagnosis	Treatment
Light bleeding Cramping lower abdominal pain	Closed cervix	Threatened miscarriage	Wait and see
Light bleeding Abdominal pain, shoulder tip pain and/or rectal pain Feeling faint on standing up, or fainting	Shock Vaginal examination should be undertaken carefully (see Section 15)	Ectopic pregnancy	See Section 15
Heavy bleeding No history of products of conception passed Cramping lower abdominal pain	Dilated cervix Tender uterus that corresponds to dates Shock if bleeding is severe Severe anaemia if bleeding is prolonged	Inevitable miscarriage	Cross match blood Treat shock if present Evacuate products of conception (ideally by manual vacuum aspiration) Give iron if the patient has anaemia
Light bleeding Mild cramping lower abdominal pain History of products of conception passed	Closed cervix Soft uterus that is smaller than expected for dates	Complete miscarriage	Check haemoglobin levels Give iron if the patient has anaemia
Heavy bleeding Nausea and/or vomiting Cramping lower abdominal pain Passage of some products of conception which look like grapes	Dilated cervix Soft uterus, larger than expected for dates	Molar pregnancy	Evacuate products of conception (ideally by manual vacuum aspiration). If symptoms persist and there is continued vaginal bleeding, repeat urine pregnancy test Measure HCG levels if possible Screen for pre-eclampsia (measure blood pressure, and urine for protein) Follow up for abnormal bleeding; if it occurs, perform a vaginal examination, ultrasound scan and measurement of HCG levels

Section 11: Symptoms and signs of emergencies in pregnancy

Vaginal bleeding in early pregnancy			
Symptoms	Signs	Diagnosis	Treatment
<p>A history of pregnancy and self-induced abortion may or may not be given</p> <p>Lower abdominal pain</p> <p>Prolonged light to heavy bleeding</p>	<p>Lower abdominal tenderness</p> <p>Foul-smelling vaginal discharge</p> <p>Pus coming from the cervix</p> <p>Fever</p> <p>Tender uterus with pain on moving the cervix</p> <p>Shock due to haemorrhage and/or sepsis</p>	<p>Induced abortion with infection</p>	<p>Treat shock if present</p> <p>IV antibiotics: Ampicillin 2 gram IV loading dose, then 1 gram IV every 6 hours <i>plus</i> gentamicin 80mg IV/IM every 8 hours or 5mg/kg body weight IV/IM once every 24 hours <i>plus</i> metronidazole 500 mg IV every 8 hours until the patient has been fever-free for 48 hours</p> <p>Manual vacuum aspiration (risk of uterine perforation): only when pulse and blood pressure are improving and after 24 hours of appropriate IV antibiotics and good urine output of > 30mL/ hour</p> <p>Correct DIC if there is a blood clotting disorder</p> <p>If the patient remains shocked after resuscitation and/or heavy vaginal bleeding continues, they will need earlier surgery</p> <p>After ensuring that there are no vaginal or cervical injuries, irrigate the vagina with sterile normal saline, Ringer-lactate or Hartmann's solution to remove any herbs or caustic substances that may have been used to induce the abortion</p>

Symptoms	Signs	Diagnosis	Treatment
<p>A history of pregnancy and self-induced abortion may or may not be given</p> <p>Lower abdominal pain</p> <p>Prolonged light to heavy bleeding</p> <p>Severe abdominal pain</p> <p>Urinary or faecal incontinence.</p> <p>Faecal discharge from vagina</p>	<p>Severe abdominal tenderness with rigid abdomen and ileus if there is peritonitis</p> <p>Foul-smelling vaginal discharge</p> <p>Pus coming from the cervix</p> <p>Fever</p> <p>Tender uterus with pain on moving cervix</p> <p>Shock due to haemorrhage and/or sepsis</p>	<p>Induced abortion with injuries to genital tract and to bowel or bladder</p>	<p>Stabilise if shocked Laparotomy to repair injuries</p> <p>Manual vacuum aspiration (high risk of uterine perforation) after checking that there are no tears in the vagina or cervix which need repair</p> <p>Appropriate IV antibiotics as above</p>

Section 11: Symptoms and signs of emergencies in pregnancy

Light bleeding is defined as taking longer than 5 minutes for a clean pad or cloth to become soaked. Heavy bleeding is defined as taking less than 5 minutes for a clean pad or cloth to become soaked.

Vaginal bleeding in late pregnancy			
Symptoms	Clinical signs	Diagnosis	Treatment
Severe constant abdominal pain Light or heavy vaginal bleeding Reduced fetal movements	Shock Tense and tender uterus on abdominal examination Fetal distress or absent fetal heart rate	Placental abruption	Call for surgical and anaesthetic help Left lateral tilt or recovery position IV fluid boluses for shock Cross-match 4 units of blood and freeze-dried plasma if available Deliver fetus as soon as possible if viable, either by inducing labour or by Caesarean section
Vaginal bleeding which can be light or very heavy Bleeding can be precipitated by intercourse or artificial rupture of membranes No pain	Soft uterus Presenting part may be higher than expected Fetus may be distressed, non-viable or uncompromised with normal movements and normal fetal heart rate pattern Ultrasound will show placenta praevia Do not undertake digital vaginal examination, as this may precipitate massive bleeding which can be fatal	Placenta praevia	Call for surgical and anaesthetic help Treat shock if present If preterm and not bleeding too heavily, give steroids, admit for bed rest, and only perform a Caesarean section if there is a further bleed Cross-match ideally 4 units of blood

Section 11: Symptoms and signs of emergencies in pregnancy

Vaginal bleeding in late pregnancy			
Symptoms	Clinical signs	Diagnosis	Treatment
Heavy vaginal and other bleeding	Shock (especially an increasing heart rate detected ideally on partograph) Abdominal distension Tender over uterus, with more easily palpable fetal parts Absent fetal movements and heart sounds	Ruptured uterus	Call for surgical and anaesthetic help Treat shock if present Cross-match ideally 4 units of blood Prepare theatre for laparotomy while resuscitating the patient

Vaginal bleeding after delivery			
Symptoms	Signs	Possible diagnosis	
Immediate heavy bleeding after birth	Uterus soft and not contracted	Atonic uterus	
Immediate heavy bleeding after birth	Uterus contracted	Trauma to cervix, vagina or perineum	
Bleeding which may be light if clot is blocking cervix	Placenta not delivered within 30 minutes of birth	Retained placenta	
Bleeding which is usually light but continues for many hours	Portion of placenta missing Uterus contracted	Retained placental parts	
Bleeding for > 24 hours	Portion of placenta missing Foul-smelling lochia may be present Fever may be present Severe anaemia	Retained placental parts with or without infection	
Lower abdominal pain of varying intensity Immediate but usually light bleeding	Uterus not felt on abdominal palpation Inverted uterus may be seen at vulva Bradycardia may be present Shock	Inverted uterus	
Usually during labour there has been a change from intermittent labour contractions to a constant pain which may become less severe after rupture has occurred Sometimes an oxytocin drip is in place Vaginal bleeding which may be light or heavy History of a previous Caesarean section or other surgery on the uterus	Shock Abdominal distension Tender over uterus	Ruptured uterus (more likely before delivery of the baby)	

Section 11: Symptoms and signs of emergencies in pregnancy

Breathing difficulties in pregnancy

All of the symptoms and signs may not be present for all of the diagnoses listed in the Table below and it is difficult to distinguish between some of them; some symptoms and signs will be a diagnosis of exclusion. It is therefore important to treat the treatable.

Symptoms that may be present	Clinical signs that may be present	Diagnosis
Weakness Tiredness	Pale conjunctiva, nail beds, palms of hands and soles of feet	Severe anaemia
Weakness Tiredness Dyspnoea	Signs of severe anaemia Oedema of legs Basal lung crepitations Tachycardia Gallop rhythm Enlarged liver Elevated jugular venous pressure (JVP)	Heart failure due to severe anaemia
Dyspnoea Cough Pleuritic chest pain	Fever Tachypnoea Respiratory distress Reduced air entry Bronchial breathing Pleural rub Rhonchi Crepitations	Acute lower respiratory tract infection (pneumonia)
Breathing difficulties in pregnancy		
Dyspnoea Cough	Respiratory distress Tachypnoea Wheezing Rhonchi Reduced air entry	Asthma
Dyspnoea Swelling of the leg Pleuritic chest pain	Tachypnoea Haemoptysis Leg pain/swelling Cyanosis Shock Central chest pain Elevated JVP Pleural rub	Pulmonary embolus
Collapse Dyspnoea	Shock Apnoea Cardiac arrest Cyanosis Coagulopathy	Amniotic fluid embolus

Section 12: Shock during pregnancy and after birth

Shock results from an acute failure of circulatory function.

The most common causes are hypovolaemia, septicaemia, the effects of trauma and very severe anaemia.

Diagnostic pointers

During assessment and resuscitation, a focused history of the previous 24 hours and previous illnesses should be obtained.

- A history of vomiting and/or diarrhoea points to fluid loss, either externally (e.g. gastroenteritis) or into the abdomen (e.g. appendicitis and peritonitis, early stages of gastroenteritis).
- A history of bleeding. This may be vaginal bleeding, or 'silent' bleeding into the abdominal cavity (as in ectopic pregnancy, placental abruption or ruptured uterus).
- Fever or a rash points to septicaemia.
- Urticaria, angioneurotic oedema or a history of allergen exposure points to anaphylaxis.
- Heart failure points to severe anaemia (usually with severe pallor), valve disease or cardiomyopathy.
- A history of sickle-cell disease or diarrhoeal illness and low haemoglobin levels points to acute haemolysis.
- A history of major trauma points to blood loss, and, more rarely, tension pneumothorax, haemothorax, cardiac tamponade or spinal cord transection.
- Severe tachycardia or signs of heart failure point to an arrhythmia or a cardiomyopathy.
- A history of polyuria, sighing respiration and a very high blood glucose level points to diabetes
- A history of drug ingestion points to poisoning.

Choice of fluid for volume replacement

Crystalloid or colloid fluids are appropriate for volume replacement in shock.

However, dextrose/glucose infusions (particularly hypotonic ones such as 5% glucose or 0.18% saline in 5% glucose) do not constitute appropriate fluid resuscitation, and can be dangerous because they lower serum sodium levels, which can result in seizures and brain swelling.

Compared with colloids, crystalloid fluids:

- diffuse more readily into the interstitial space
- may be associated with more peripheral oedema
- where capillary leak exists, allow more water to enter the interstitial space, because of the lower osmotic pressure
- need two to three times the volume of colloids to expand the vascular space
- have been reported to be associated with lower mortality

Nevertheless, the use of both crystalloids and colloids is appropriate, although crystalloids (e.g. Ringer-lactate or Hartmann's solution or 0.9% saline) are more likely to be available.

Choice of crystalloid

The fluid that was traditionally infused into the circulation for the management of shock was normal saline (0.9% sodium chloride). This fluid has increasingly been shown to be dangerous, especially in the sick patient. An infusion of normal saline causes a hyperchloraemic acidosis (a high chloride concentration leading to an acidosis) which, in the shocked patient, who is already acidotic, causes a deterioration in the health of cells in vital organs, even though perfusion of the cells has been improved by the increased circulating volume.

There are sodium-containing alternatives to normal saline that are safer as they approximate more closely to human serum/plasma in content, although they are slightly more expensive. We recommend the use of either of these alternatives – Ringer-lactate and Hartmann's solution, which are widely available – for all fluid replacement.

Section 12: Shock during pregnancy and after birth

Blood

If there is significant blood loss or pre-existing severe anaemia in the face of any blood loss, blood will be needed. Full cross-matching takes about 1 hour to perform. For urgent need, type-specific non-cross-matched blood (which is ABO- and rhesus-compatible, but has a higher incidence of transfusion reactions) takes about 15 minutes to prepare. In dire emergencies, O-negative blood must be given.

Fluids should be warmed, especially if they are needed in large volumes. In the absence of heaters, bags of fluid or blood can be warmed by placing them under the clothes next to the skin of a relative. Even this takes time, and another method is to pass the tubing of an IV set through a bowl containing warm water.

Primary assessment indicating shock

- Fast, weak pulse (≥ 100 – 110 beats/minute).
- Pallor (especially of the inner eyelids, palms or around the mouth).
- Sweatiness or cold clammy skin.
- Rapid breathing (> 30 breaths/minute).
- Anxiety, reduced conscious level, confusion or unconsciousness.
- Low blood pressure (systolic pressure less than 90 mmHg is a late sign).
- Reduced urine output (< 30 mL/hour).

Resuscitation

Airway and haemorrhage control

If heavy bleeding is the suspected cause of shock, take immediate steps to stop the bleeding. For example in PPH uterotonic drugs such as oxytocin or misoprostol, uterine massage, bimanual compression, aortic compression and condom catheter, and anti-shock garment are urgently required. Urgent surgical intervention may be required (e.g. for ruptured ectopic pregnancy).

- Use an opening manoeuvre if the airway is not open or is partially obstructed. Keep the airway open. If there is improvement but the airway closes without active opening support, consider airway adjuncts to maintain the airway if the patient is unconscious (P or U on the AVPU scale).
- Suction if necessary.
- Maintain and protect the airway by intubation undertaken by experienced help (if available).

Breathing

- Provide a high concentration of oxygen through a facemask with a reservoir bag if there is adequate spontaneous respiration.
- For patients with inadequate ventilation, respiration should be supported with oxygen via a bag-mask, and experienced help should be summoned (if available).

Circulation

- Gain IV access.
- Use a short, wide-bore (16- to 18-gauge) IV cannula if possible for IV access.
- Access via the internal or external jugular veins is a good option if peripheral access is impossible. Long saphenous vein cut-down may also be considered, and the new intraosseous drill can be used if all else fails (see Section 9).
- Applying pressure on the site of the bleeding can be valuable in many circumstances, including postpartum haemorrhage (see Section 15) and external haemorrhage from major trauma (Section 42).
- Try to obtain two vascular access sites to give large volumes quickly, and in case one line is lost.
- A blood pressure cuff can be used to speed up infusions in emergency situations. Wrap the cuff around the blood/fluid bag and place it inside a non-compressible bag. (see Figure 12.1).



Figure 12.1 BP cuff around IV fluid bag

- Use the left lateral tilt position or recovery position if unconscious to minimise aortic and vena caval compression, and to reduce the risk of aspiration in patients after 20 weeks' gestation.
- Elevate the legs by raising the foot of the bed.
- Consider using a non-pneumatic anti-shock garment (NASG).
- Give an initial rapid bolus of 500 mL to 1 L of Ringer- lactate or Hartmann's solution or blood if the patient is haemorrhaging. A colloid at the same dose can also be given, if available. It is essential that the bolus is given as rapidly as possible. In the absence of syringe pumps, it should be manually pushed in using a 20- to 50-mL syringe (using a three-way tap and link to an IV giving set).
- Further boluses of 500–1000 mL will usually be required in the first hour. Once more than 2 litres have been given IV, complications such as pulmonary or cerebral oedema may occur. Expert help, including CVP monitoring, is very valuable if it is available.

The concept of *'targeted crystalloid fluid-resuscitation'* requires urgent research into shock due to obstetric haemorrhage. Here the initial boluses of IV crystalloids required to treat shock would only be given to keep the vital organs (especially the brain, heart and kidneys) perfused before blood becomes available and, of most importance, surgery and specific medical treatments to stop the bleeding have started to take effect. The administration of too large a volume of IV crystalloids fluids may increase the blood pressure, damage clotting and disrupt early clot formation.

If this approach is used when giving boluses of crystalloid in shock due to bleeding (before blood is available and before procedures undertaken to stop haemorrhage are effective), only the amount necessary to keep the blood pressure at a level sufficient to perfuse the vital organs is given. There is no clear evidence to indicate the precise blood pressure that should be achieved in a woman in shock due to haemorrhage. However, adequate perfusion of vital organs may best be indicated by a radial pulse which can be palpated and an alert conscious level. During pregnancy, the adequacy of the fetal heart rate may also be helpful.

Our personal practice, especially in low resource settings, is to start with IV boluses of 500 mL of crystalloid and reassess after each bolus, always aiming to stop haemorrhage and obtain blood for transfusion as soon as possible. In situations where there is brisk active blood loss and delay in obtaining blood or effective intervention to halt the bleeding, several boluses of crystalloids may be required. **The importance of undertaking measures to halt the bleeding and obtaining blood for transfusion rapidly cannot be overstated.**

Tranexamic acid

This should be started as soon as possible after the onset of major haemorrhage.

Section 12: Shock during pregnancy and after birth

The loading dose is 1 gram over 10 minutes followed by an IV infusion of a further 1 gram over a period of 8 hours. The slow IV bolus dose is given by injecting 1 gram of tranexamic acid into a 100-mL bag of 0.9% saline and letting it run through over a period of about 10–20 minutes (the exact timing is not crucial). The 8-hour infusion is given by injecting 1 gram of tranexamic acid into a 500-mL bag of 0.9% saline and giving it over a period of 8 hours (approximately 60 mL/hour).

Keep the patient warm but do not overheat.
Transfuse blood as soon as possible to replace blood loss.

Determine the cause of bleeding

- If bleeding occurs before 24–28 weeks of pregnancy, suspect miscarriage, induced abortion, ectopic pregnancy or molar pregnancy.
- If bleeding occurs after 24–28 weeks or during labour, but before delivery, suspect placenta praevia, abruption placentae or ruptured uterus.
- If bleeding occurs soon after childbirth, suspect atonic uterus, retained placental fragments, ruptured uterus, tears of the genital tract or occasionally an inverted uterus.
- In all cases consider the possibility of a primary or secondary blood clotting disorder.

Whole blood clotting time

If laboratory clotting tests are not available:

- Transfer 2 mL of venous blood into a small dry clean plain glass test tube (approximately 10 mm × 75 mm).
- Hold the tube in your closed fist to keep it warm (+ 37°C).
- After 4 minutes, tip the tube slowly to see if a clot is forming. Then tip it again every minute until the blood clots and the tube can be turned upside down.
- **Failure of a clot to form after 7 minutes, or formation of a soft clot that breaks down easily, suggests a blood clotting disorder.**

Cases where infection is the suspected cause of shock (septicaemia)

- Collect appropriate samples (blood cultures, urine, pus, swabs) for microbial culture before starting antibiotics, if facilities are available but do not delay giving antibiotics because of specimen collection.
- Give a combination of antibiotics to cover aerobic and anaerobic infections, and continue until the patient has been fever-free for 48 hours:
 - benzyl penicillin 2.4 grams initially, then 1.2 grams IV 6-hourly or ampicillin 2 grams initially, then 1 g IV/IM every 6 hours **plus** gentamicin 80 mg IV/IM 8-hourly or 5 mg/kg body weight IV/IM once every 24 hours **plus** metronidazole 500 mg IV every 8 hours
 - or ceftriaxone 2–4 grams IV once daily or cefotaxime 2 grams 12-hourly IV **plus** metronidazole 500 mg IV every 8 hours.
 - if peritonitis is possible, always add metronidazole IV.
- If the patient is in shock, do not give antibiotics by mouth or IM, as they will not be absorbed.
- Reassess the patient's condition for signs of improvement.

Cases where haemorrhage due to trauma is the cause of shock

- Try and stop haemorrhage and if appropriate prepare for surgical intervention.
- Give 500 mL IV crystalloid fluid resuscitation boluses and reassess circulation after each bolus until blood is available (see above).

General issues

Section 12: Shock during pregnancy and after birth

Do not give IV boluses of 5% dextrose or dextrose saline (4%/0.18%), as they cause hyponatraemia, and may result in cerebral oedema and death.

An antibiotic such as cefotaxime or ceftriaxone should always be given IV when a diagnosis of septicaemia with a purpuric rash (suspect meningococcal infection).

Take blood for the following investigations (if available): full blood count (FBC), renal and liver function tests, blood culture, cross-matching, blood clotting, glucose stick test and glucose laboratory test.

Catheterise and monitor urine output.

Cases where a blood clotting disorder is present and fractionated blood products are not available

- Use fresh whole blood (straight from the donor if possible). In general, in obstetric emergencies, volume overload is not a problem.
- If volume overload is a concern, allow the unit of fresh whole blood to stand for 30 minutes. The red blood cells will drop to the bottom, and the fluid/plasma above them containing clotting factors can be drawn off with a syringe and needle, and plasma alone can be given.

Central venous access

This can be valuable provided that the healthcare workers present have the skills needed **to do this safely and rapidly** as it is potentially hazardous. The catheter should be inserted in the superior vena cava or intra-thoracic inferior vena cava or via the femoral, internal jugular or subclavian vein routes. However, it is essential that resuscitation is not delayed by trying to insert a central venous catheter. If there is a clotting disorder, never use the subclavian route.

A normal central venous pressure (CVP) is 4–10 cmH₂O, and optimising the CVP can improve cardiac output with less risk of inducing heart failure. Take great care if the CVP is > 12 cm H₂O, as cardiac failure may be induced by excessive IV fluids, especially if severe anaemia, malnutrition or a primary cardiac disorder is present.

Reassess ABC on a regular basis.

Reassess the response to fluids to determine whether the woman's condition is improving.

Signs of improvement include the following:

- decreasing pulse rate (a rate of ≤ 100–110 beats/minute)
- increasing blood pressure (systolic pressure ≥ 90–100 mmHg)
- improving mental status (less confusion or anxiety)
- increasing urine output (≥ 30 mL/hour).

Continue monitoring to ensure that the pulse rate and blood pressure do not deteriorate after improvement, indicating the return of shock.

If the mother's condition improves, adjust IV fluids to 1 litre over 6 hours, and continue management for the underlying cause of shock.

If more than 3 litres have been given IV in a mother, and if shock is still present, call for anaesthetic assistance.

Correct any hypoglycaemia.

Inotropes

An IV infusion of dobutamine and/or dopamine at 5–20 micrograms/kg/minute should be considered, especially if a third bolus of fluid is required. Sometimes adrenaline by IV infusion at 0.05–2 micrograms/kg/minute may be required.

These infusions can initially be given carefully through a peripheral vein until central venous access is obtained.

Section 12: Shock during pregnancy and after birth

Figure 12.2 Shock in pregnancy or the puerperium: pathway of care.

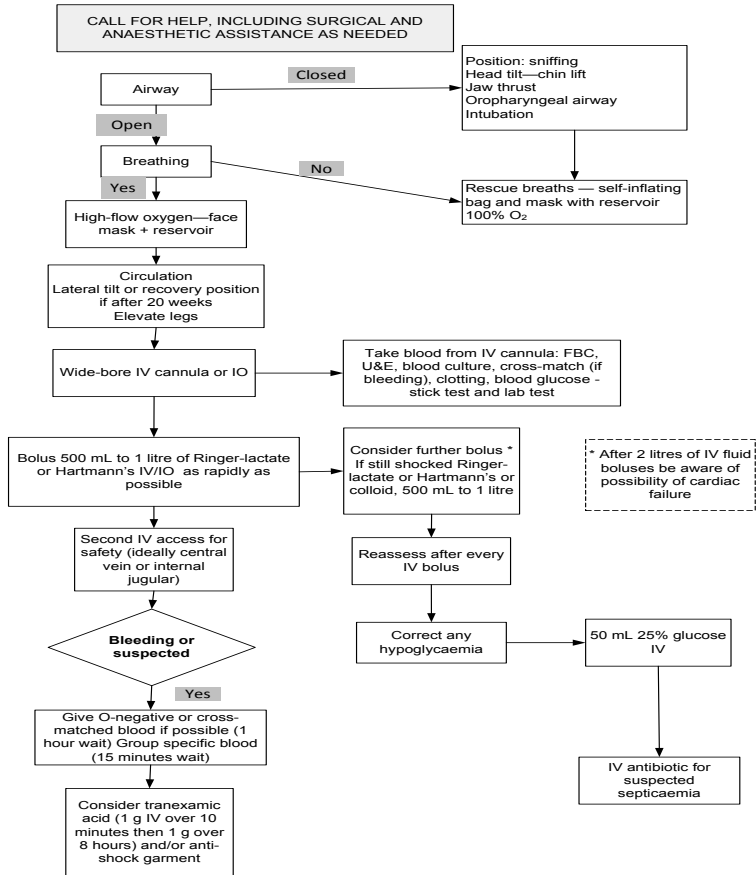

Section 13: Severe anaemia, including sickle-cell disease

In normal pregnancy there is an increased total blood volume and a marked increase in plasma volume, so the haemoglobin concentration falls. Pathological anaemia is mainly due to iron deficiency, associated with depleted iron stores before pregnancy and poor diet. Malaria is another major cause of anaemia in pregnancy. Where amoebiasis and other hookworms are endemic, these may worsen the anaemia.

Anaemic women cope poorly with blood loss at delivery.

Severe anaemia is present if haemoglobin levels are less than 5.0 g/dL or if there are signs of heart failure and haemoglobin levels are less than 7.5 g/dL. This condition is very dangerous for both mother and baby.

Presentation of severe anaemia

- The patient will be weak, with near white palms, soles and tongue, and signs of heart failure if the anaemia is severe (see below).
- In haemolysis, the urine may be dark brown in colour and there may be signs of jaundice.

Treatment of severe anaemia in pregnancy

Treatment of severe anaemia if heart failure is not present, give ferrous sulphate 200 mg orally three times a day, vitamin C 1000 mg daily and folic acid 5 mg once daily. If vitamin C is not available, iron tablets may be taken with orange juice to aid absorption.

Parenteral IV iron: parenteral administration produces a larger and more rapid rise in haemoglobin levels, and is more effective in replenishing ferritin levels, so might be necessary for patients who cannot tolerate oral preparations or who are non-compliant, or if the anaemia is diagnosed late and rapid correction is required.

Parenteral iron is **best given IV**. Intramuscular injections are painful and may stain the skin. **Do not give parenteral iron during the first trimester.**

IV preparations: the side effects of intravenous iron preparations are less common with iron sucrose than with iron dextran. Side effects of iron dextran include arthralgia, myalgia, pyrexia, flushing and hypotension. Serious hypersensitivity is observed in approximately 1 in 200 patients with iron dextran (low-molecular-weight dextran) and 1 in 50000 with iron sucrose.

Iron sucrose (Venofer®): 200 mg (elemental iron). For IV infusion, dilute 10 mL of iron sucrose (200 mg) in 100 mL of 0.9% saline and infuse immediately after dilution. The first 10 mL (20 mg) should be given slowly over 10 minutes and the remainder over 1 hour. No test dose is required for iron sucrose, as anaphylaxis is rare with this preparation. However, adrenaline must be available. A fall in blood pressure is possible if the iron infusion is given too quickly. IV infusions can be repeated weekly if the required rise in haemoglobin levels is not achieved, up to a maximum total dose of 1000 mg.

Treat for malaria, give prophylaxis (see Textbook), and prevent future inoculations with impregnated bed nets.

Treat any chronic parasitaemia (e.g. hookworm, schistosomiasis) (Textbook).

Where hookworm is endemic (prevalence of 20% or more), give one of the following antihelmintic treatments:

- albendazole 400 mg by mouth once; this must not be given in the first trimester because it causes fetal anomalies
- or mebendazole 500 mg by mouth once or 100 mg twice a day for 3 days
- or levamisole 2.5 mg/kg body weight by mouth once daily for 3 days
- or pyrantel 10 mg/kg body weight by mouth once daily for 3 days.

Where hookworm is highly endemic (prevalence of 50% or more), repeat the antihelmintic treatment 12 weeks after the first dose.

Treatment of severe anaemia where there is heart failure

Section 13: Severe anaemia and sickle cell disease

Give a high concentration of oxygen, bed rest and sit the patient upright (with lateral tilt as well if she is more than 20 weeks pregnant).

- Consider transfusion with packed cells if the haemoglobin concentration is less than 5.0 g/dL (with IV furosemide of 40 mg for each unit of packed cells). If blood cannot be centrifuged, let the bag hang until the cells have settled. Infuse the cells slowly and dispose of the remaining serum.
- Partial exchange transfusion may be helpful. Use a cannula in a large vein in the antecubital fossa, withdraw 20 mL of the patient's anaemic blood and infuse 40 mL of new blood (ideally packed red blood cells) over 5 minutes and repeat 5–10 times.

If labour occurs when the patient is severely anaemic:

- Deliver with the patient sitting up.
- Cross-match blood and have it available in case of postpartum haemorrhage.
- Avoid a prolonged second stage as this increases the risk of PPH.
- If there are signs of heart failure or maternal exhaustion shorten the second stage with a ventouse if possible.
- Manage the third stage actively (give oxytocin), and suture tears without delay.
- The mother is in great danger for at least 48 hours after delivery. Prescribe iron and folate during the puerperium.

Sickle-cell anaemia in pregnancy

Treatment of acute painful crisis is the same as that for non-pregnant patients, with hydration, oxygen and analgesics, although doses analgesia may be higher. Reassurance should be given that morphine use during pregnancy does not jeopardise the baby's health. However, if large doses of morphine are needed in late pregnancy, the newborn may require opioid weaning.

Care during delivery

- Inform the multidisciplinary team if available (the senior midwife in charge, senior obstetrician, anaesthetist and haematologist) when labour is confirmed.
- Intravenous fluids should be administered if oral hydration is inadequate. A fluid balance chart should be kept.

Changes during the intrapartum period:

- There is an increased frequency of sickle-cell crises.
- Cardiac function can be compromised
- There is an increased risk of painful crises with protracted labour (more than 12 hours). If the woman is well hydrated and labour is progressing, the labour should be carefully supervised. Caesarean section should be considered if labour is not progressing well and delivery is not imminent.
- There is an increased oxygen demand. Use of pulse oximetry to detect hypoxia is appropriate. If the oxygen saturation is 94% or less, oxygen should be given by nasal cannula.

A raised temperature ($> 37.5^{\circ}\text{C}$) requires investigation. The clinician should have a low threshold for commencing broad-spectrum antibiotics.

Postpartum care

- If the baby is at high risk of SCD (based on parental haemoglobinopathy results), early testing for SCD should be offered.
- Maintain maternal oxygen saturation above 94% and adequate hydration based on fluid balance until discharge.
- Low-molecular-weight heparin (or unfractionated heparin if former not available) should be administered while the woman is in hospital and for 7 days post-discharge following vaginal delivery, or for a period of 6 weeks following Caesarean section.
- Anti-thrombotic stockings are recommended in the puerperium.
- The risk of sickle-cell crisis is increased. Hydration and oxygenation should be maintained and early mobilisation encouraged. Crises should be managed as for non-

Section 13: Severe anaemia and sickle cell disease

pregnant women. NSAIDs can be given in the post- partum period and during breastfeeding. Breastfeeding should be encouraged.

- Postpartum contraceptive advice should be given. Progestogen-containing contraceptives, injectable contraceptives and the levonorgestrel intrauterine system are safe and effective in SCD. Oestrogen-containing contraceptives should be used as second-line agents.
- Barrier methods are as safe and effective in women with SCD as in the general population.

Section 14: Septic abortion or miscarriage

Consider the possibility of septic abortion in any woman or girl with a history of termination of pregnancy or attempted termination. Presentation is typically with some of the following *symptoms and signs*: lower abdominal pain, prolonged vaginal bleeding, tender uterus, foul-smelling vaginal discharge, purulent cervical discharge, fever and malaise.

If **septic shock** is present, this will be shown by some of the following signs and symptoms:

- fast, weak pulse (≥ 100 – 110 beats/minute)
- pallor (especially of the inner eyelid, palms or around the mouth)
- sweatiness with cold or warm (vasodilated) skin
- rapid breathing (> 30 breaths/minute)
- anxiety, confusion or unconsciousness
- low blood pressure (systolic pressure < 90 mmHg is a late sign)
- reduced urine output (< 30 mL/hour).

Resuscitation if necessary for shock then proceeds as described below.

Airway

- Use an opening manoeuvre if the airway is not open or is partially obstructed. Keep the airway open. If there is improvement but the airway closes without active opening support, consider airway adjuncts to maintain the airway if the patient is unconscious (P or U on the AVPU scale).
- Suction if necessary.
- The airway may need to be maintained and protected by intubation, using experienced senior help (if available).

Breathing

- Provide a high concentration of oxygen through a face-mask with a reservoir bag if there is adequate spontaneous respiration.
- For patients with inadequate ventilation, respiration should be supported with oxygen via a bag-mask, and experienced senior help summoned (if available).

Circulation

- Gain IV access.
- Use a short, wide-bore (16- to 18-gauge) IV cannula if possible for IV access.
- The internal jugular and external jugular veins are good options for access if peripheral access is impossible. Long saphenous vein cut-down may also be considered.
- Try to obtain two vascular access sites to give large volumes quickly, and in case one line is lost.
- Elevate the legs by raising the foot of the bed.
- Give an initial rapid IV/IO bolus of 500 mL to 1 litre of Ringer-lactate or Hartmann's solution. It is essential that the bolus is given as rapidly as possible.
- Further boluses of 500–1000 mL will usually be required during the first hour. Once more than 2 litres have been given IV, complications such as pulmonary or cerebral oedema may occur. If available, expert help, an anaesthetist, and the use of inotropes, sodium bicarbonate, and intermittent positive pressure ventilation (IPPV) with positive end-expiratory pressure (PEEP) are all potentially valuable.
- A fresh blood transfusion may also be important.

Give antibiotics after taking specimens for culture if facilities are available (blood cultures, high vaginal swab and urine)

All patients, whether shocked or not, must be given the following antibiotics without delay:

- ampicillin 2 grams IV every 6 hours
- **plus** gentamicin 80 mg IV/IM 8-hourly or 5 mg/kg body weight IV/IM every 24 hours
- **plus** metronidazole 500 mg IV every 8 hours.

All antibiotics should be continued until the woman has been fever-free for 48 hours.

Section 14: Septic abortion or miscarriage

Patients who do not appear to be shocked on first examination must still be frequently observed for the early signs of shock during the first 6–12 hours. The frequency of observations can then be reduced.

Start antibiotics as soon as possible and before attempting manual vacuum aspiration (MVA).

The patient may also need the following:

- MVA to remove infected products of conception; preferable to curettage, because perforation may already have occurred, or could easily do so because of the friable nature of the uterine wall
- Hysterectomy after stabilisation if infection cannot be controlled.

Section 15: Major obstetric haemorrhage

Ruptured ectopic pregnancy

Clinical presentation: symptoms and signs

- Lower abdominal pain (which tends to be unilateral), cramping or stabbing, due to distension of the tube and peritoneal irritation from blood in the abdominal cavity. Rupture results in generalized abdominal pain, often associated with distention, guarding and rebound tenderness (peritonism).
- Shoulder tip pain, caused by blood irritating the diaphragm.
- Rectal pain or perineal discomfort caused by blood in the pouch of Douglas.
- Diarrhoea is atypical but can be the main presenting complaint.
- Hypovolaemic shock occurs as soon as sufficient blood has been lost. Often there will be fainting or a feeling of faintness that requires the patient to lie down.
- A fast weak pulse (heart rate ≥ 100 beats/minute).
- Hypotension (a late sign after much blood lost: systolic pressure < 90 mmHg).
- Vaginal bleeding, which can mimic a normal menses (75%):
 - usually dark, and not heavy
 - may be irregular.
- Signs and symptoms of early pregnancy may occur but are unusual. They include tiredness, nausea and/or vomiting (especially in the early morning), breast swelling and urinary frequency.
- Anaemia if there is chronic slower bleeding.

In all women and girls of reproductive age with above symptoms, especially dizziness or fainting, do a pregnancy test and consider the possibility of ectopic pregnancy.

Abdominal examination reveals muscle guarding and rebound tenderness. A low grade fever may be present and the differential diagnosis is appendicitis. There may be abdominal distension with shifting dullness if there is free blood in the abdomen.

Pelvic examination: caution must be exercised when performing a bimanual vaginal examination if an ectopic pregnancy is possible, because of the risk of rupture during and due to the examination. Vaginal examination may show general pelvic tenderness, sometimes with a mass in the fornix, or increased tenderness on one side. There may be cervical excitation, bluish discoloration of the vagina and cervix and/or slight uterine enlargement.

Diagnosis

Consider this diagnosis in particular if any anaemia, shock or abdominal pain is greater than expected for the amount of vaginal bleeding. Check whether the woman or girl has any risk factors for an ectopic pregnancy.

Differential diagnosis: threatened miscarriage, acute or chronic pelvic inflammatory disease (PID), torsion or rupture of an ovarian cyst, acute appendicitis or peritonitis.

Tip test: Tilt the head down. If there is blood in the peritoneal cavity it will irritate the diaphragm; this is manifested as shoulder tip pain. This test is useful if it gives a positive result, but a negative result does not exclude haemorrhage.

Do a pregnancy test in all potentially fertile women and girls with abdominal pain, fainting or shock. If they are unable to provide a urine specimen, consider using a urinary catheter to obtain one.

Ultrasound examination

If there is a positive pregnancy test but no intrauterine pregnancy is seen on the ultrasound scan, an ectopic pregnancy is likely. The likelihood of ectopic pregnancy increases if free fluid and/or an echogenic mass is seen.

Culdcentesis is not recommended, as it may delay surgery and introduce infection.

Section 15:Major obstetric haemorrhage: ruptured ectopic

Primary assessment and resuscitation of shocked patients

Call for help. A surgeon and anaesthetist must be urgently requested, and the operating theatre must be prepared.

Airway

- Use an opening manoeuvre if the airway is not open or is partially obstructed. If there is an improvement, use airway adjuncts to support the airway or ask an assistant to hold it open.
- Suction if necessary.
- The airway may need to be maintained and protected by intubation using experienced senior help (if available).

Breathing

- Provide a high concentration of oxygen through a face-mask with reservoir bag for patients with adequate spontaneous respiration.
- For patients with inadequate ventilation or depressed conscious level (P or U on the AVPU scale), respiration should be supported with oxygen by bag-valve-mask inflations and experienced senior help obtained, including an anaesthetist.

Circulation

- Elevate the legs and consider using a non-pneumatic anti-shock garment.
- Gain IV access.
- Use a short wide-bore IV cannula if possible (14- to 16-G).
- External jugular vein access is a good option if peripheral access is impossible. Long saphenous vein cut-down may also be considered, and, if the operator is adequately trained, central venous access ideally via the internal jugular vein can be extremely helpful, or the intra- osseous route if this is not possible (see Section 9).
- If sufficient staff available try to obtain two vascular access sites in order to give large volumes quickly, and in case one line is lost.
- Take blood for cross-matching of 4–6 units, full blood count, renal function tests (if available) and blood clotting.
- Give 500 mL to 1 litre of Ringer-lactate or Hartmann's solution by rapid bolus while awaiting blood for transfusion.
- Remember that young healthy women can lose a lot of blood before they become shocked, especially if it is a slow leakage rather than a sudden large loss of blood.

The concept of targeted crystalloid fluid resuscitation is important in management. Here the initial boluses of IV crystalloids required to treat shock would only be given to keep the vital organs (especially the brain, heart and kidneys) perfused before blood and, most important of all, surgery have become available.

The administration of too large a volume of IV crystalloid fluids by increasing blood pressure and damaging the coagulation system could increase bleeding by disrupting early clot formation.

If this approach is adopted when giving boluses of crystalloid to patients who are in shock due to bleeding, before blood becomes available and here, of most importance, surgical intervention, only the amount needed to keep the blood pressure at a level sufficient to perfuse the vital organs would be given. There is no clear evidence to indicate the precise blood pressure that should be achieved in a woman in shock due to a ruptured and bleeding ectopic pregnancy. However, adequate perfusion of vital organs may best be indicated by a radial pulse that can be palpated and an alert conscious level.

Our personal practice is to start with IV boluses of 500 mL of crystalloid or ideally blood and reassess after each bolus always aiming for urgent surgical intervention and blood transfusion. Several boluses of crystalloids may be required before these actions are possible.

Disability

Conscious level on AVPU scale.

Emergency treatment

Section 15:Major obstetric haemorrhage: ruptured ectopic

If the diagnosis is ruptured ectopic pregnancy with shock, order blood for transfusion and immediately prepare the operating theatre. **Obtain a surgeon urgently, and proceed to urgent laparotomy while resuscitation is under way.** Do not wait for blood.

At laparotomy, perform salpingectomy. Repair of the tube carries a major risk of future ectopic pregnancy, and should not be undertaken in resource-limited settings.

Autotransfusion

If blood is free from infection, it can be collected after the abdomen has been opened and transfused.

When the woman is on the operating table prior to surgery and the abdomen is distended with blood, it is sometimes possible to insert a needle through the abdominal wall and collect the blood in a donor set.

Alternatively, open the abdomen and proceed as follows:

- Scoop the blood into a basin and strain it through gauze to remove all clots.
- Clean the top portion of a blood donor bag (containing anticoagulant) with antiseptic solution and open it with a sterile blade.
- Pour the mother's blood into the bag and infuse it through a filtered set in the usual way.
- If a donor bag with anticoagulant is not available, add 10 mL of 0.3 molar sodium citrate to each 90 mL of blood.

Miscarriage

Consider miscarriage or induced abortion in any woman or girl of reproductive age if more than 1 month has elapsed since her last menstrual period, and one or more of the following is present: bleeding, lower abdominal pain, partial expulsion of products of conception, dilated cervix, or smaller uterus than expected for gestation.

Spontaneous miscarriage

This is the loss of a pregnancy before fetal viability (28 weeks' gestation in low-resource settings). It occurs in at least 15% of pregnancies.

The stages of spontaneous miscarriage include the following:

1. threatened miscarriage: pregnancy may continue
2. inevitable miscarriage: pregnancy will not continue and will proceed to incomplete or complete miscarriage
3. incomplete miscarriage: products of conception are partially expelled.
4. complete miscarriage: products of conception are completely expelled.
5. missed miscarriage: is not associated with symptoms but found incidentally on routine ultrasound scan or when ultrasound is performed to investigate a pregnancy that is not growing as anticipated. The time from fetal demise to expulsion from the uterus varies widely and it is not uncommon for a miscarriage to remain in situ for many weeks.

Miscarriages can be complicated by infection (see Section 14).

1.Threatened miscarriage

Here there is light vaginal bleeding and sometimes cramping lower abdominal pain. On examination there is a soft uterus corresponding in size to the date of the last menstrual period, and the cervix is closed.

Ideally in the presence of bleeding the viability of the pregnancy should be assessed by sonicaid/Pinnard stethoscope (if gestation permits) or by ultrasound. However, if the bleeding is light and self-limiting and ultrasound is not easily available then a conservative approach can initially be followed. Advise the woman to avoid strenuous exercise and sexual intercourse but bed rest is not necessary. Follow her up in the antenatal clinic. If the bleeding continues, assess for fetal viability and if the equipment is available perform an ultrasound scan. There is no medication that can prevent progression to a complete miscarriage. Take blood for group analysis in case bleeding becomes worse in the future.

2. Inevitable miscarriage

This can be diagnosed clinically by the findings of an open internal cervical os and/or the passage of products of conception per vagina. If in doubt the diagnosis should be confirmed by ultrasound.

3. Incomplete miscarriage

Here there is a history of significant bleeding (greater than menstruation), often with passage of clots and fetal tissue and varying degrees of lower abdominal pain secondary to uterine contraction. Bleeding can vary in severity and the cervix may be open or closed. Often the bleeding has reduced and almost stopped in which case, a complete miscarriage is an important differential diagnosis.

Diagnose by visualisation or palpation of products of conception in or through the cervical os, or by visualisation of retained products of conception on ultrasound.

Management of miscarriage

There are three broad methods for managing miscarriage:

- 1 **Expectant:** No medical or surgical intervention is made but the patient is monitored for spontaneous resolution. This relies on ready access to emergency treatment and careful follow-up.
- 2 **Medical:** Medication is used to expedite or induce expulsion of the retained products of conception. In resource poor settings this is generally used only for later mid-trimester miscarriages (below).
- 3 **Surgical:** The uterus is surgically evacuated of the products of conception.

Surgical Management

If pregnancy is less than 16 weeks surgical management is preferred where access to care and follow-up are restricted.

If the pregnancy is 12 to 16 weeks gestation with an unfavourable cervix that is likely to be difficult to dilate, then consideration should be given to:

- 1 'ripening' the cervix with misoprostol 200 to 600 micrograms around 3 to 24 hours prior to the procedure
- 2 Using medical induction as for gestations of 16 weeks and over (below).
- 3 Expectant management – especially if the patient appears to be contracting and is otherwise stable
- 4 Performing the surgery under optimal conditions: in an operating theatre with local anaesthetic, the availability of a general anaesthetic, and with an experienced practitioner available.

If the cervix is open and/or some products have already been expelled a sponge forceps can be used to remove products of conception if they are visibly protruding through the cervix. A manual evacuation of the uterus can then be performed to ensure evacuation is complete.

- Manual vacuum aspiration (MVA) (see Figures 15.1 to 3) is the preferred method of evacuation. Evacuation by curettage should only be used if MVA is not available.

Figure 15.1 Manual vacuum aspiration kit including cannulae of different sizes.



- If evacuation is not immediately possible and there is significant bleeding, give ergometrine 200–500 micrograms IM or misoprostol 200 micrograms orally, sublingually or rectally.
- Proceed to evacuation as soon as possible.

If the pregnancy is more than 16 weeks; a late miscarriage:

Expectant management is most appropriate when the miscarriage is progressing on its own.

Medical management includes oxytocin, mifepristone and misoprostol.

Surgical management for retained placental tissue either by Manual Vacuum

Aspiration/curettage or, after 24 weeks, manual removal of the placenta is sometimes required. *It is very important that a late miscarriage, which can cause chronic vaginal bleeding, is recognised.*

Safe evacuation of retained products of conception (MVA or by curette)

1 Explain the procedure and the reasons for undertaking it, and obtain consent.

2 This must be a surgically aseptic procedure, with the use of sterile gloves and gown. Apply antiseptic solution (such as 0.5% chlorhexidine) to the vagina and cervix (especially the os) by first inserting a high-level disinfected or sterile speculum into the vagina and then using a sterile or high-level disinfected sponge forceps with a cotton or gauze swab and giving three applications of antiseptic.

3 Where possible perform the procedure in the operating theatre. This is especially indicated if there is a risk of heavy bleeding (e.g. molar pregnancy, suspected coagulation disorder), if the procedure is poorly tolerated by the patient or if the cervical os is difficult to dilate or difficult to access.

4 Even when bleeding is not heavy, give oxytocin 10 units IM or ergometrine 200 micrograms IM before MVA to make the uterus firmer and reduce the risk of perforation.

5 Prepare the MVA syringe by closing the pinch valve and pulling back on the plunger until its arms lock. In the case of large amounts of retained products (e.g. molar pregnancy), prepare two or three syringes.

6 Bimanually examine the uterus to assess whether it is anteverted or retroverted prior to instrumentation and to access its size.

7 Provide an oral analgesic, paracetamol 1 gram, and if the cervix is not dilated sufficiently to pass the MVA catheter, prepare 20 mL of 0.5% lignocaine (without adrenaline) with a 3.5 cm long 22- or 25-gauge needle to perform a paracervical nerve block (see 11 below).

8 Using a Cusco's or Sims' speculum or vaginal retractor, visualise the cervix. You will need an adequate light source.

Section 15: Major obstetric haemorrhage: miscarriage

9 Inject 1 mL of 0.5% lignocaine into the anterior or posterior lip of the cervix, whichever has been exposed, if a tenaculum is to be used.

10 Apply either a tenaculum or sponge (ring) forceps (the latter do not require administration of local anaesthetic, and are less likely to tear the cervix) to the lip of the cervix.

11 If the cervix is insufficiently dilated for the MVA catheter to be passed, perform a paracervical nerve block following slight traction applied to the cervical lip to identify the junction between the cervix and the vaginal wall where injections of lignocaine are to be made. Inject 2 mL of 1% lignocaine just under the epithelium (no deeper than 3 mm) at 3, 5, 7 and 9 o'clock positions. Ensure that the needle is not in a vein with each injection by drawing back the needle before injection, as IV injection of lignocaine is dangerous and can cause convulsions and cardiac arrest. Wait 2 minutes and check that the cervix is anaesthetised by pinching it gently with forceps. If the pinch is felt, wait for another 2 minutes.

12 Grasp the lip of the cervix with the sponge forceps and apply gentle traction. Cervical dilatation with Hegar dilators is only needed where the cervical os is not dilated and is firm. Slowly introduce the dilators (the smallest one first) into the cavity, checking carefully whether the uterus is anteverted or retroverted, until the resistance felt on passage through the closed internal os is released and the dilator is felt to pass through it into the uterine cavity. Usually a dilatation of 10–12 mm is sufficient. Ensure that the cervix is not torn or a false passage created by the dilators.

Figure 15.2 Inserting the MVA cannula

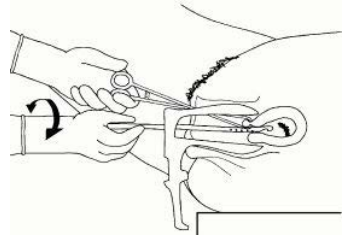
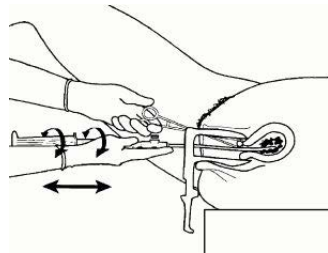

Figure 15.3 Evacuating the uterine contents



13 Pass the MVA cannula gently with a rotating movement through the cervix into the uterine cavity just beyond the internal os. Slowly push the cannula into the uterus until it touches the fundus. Measure the depth by dots visible on the cannula and then withdraw the cannula by about 0.5 cm. Note the depth of the cavity and do not pass instruments beyond this. The risk of uterine perforation is higher in cases complicated by sepsis, or in a postpartum uterus with retained products of conception (see Section 14). Also be aware that as it is evacuated the uterus generally contracts and thus the cavity will be smaller by the end of the procedure. Attach the prepared MVA syringe to the cannula and release the pinch valves, allowing the vacuum to transfer to the cannula and the inside of the uterus. Evacuate the uterine contents by gently rotating the syringe from 10 to 12 o'clock and moving the cannula back and forth within the uterus. Do not allow the cannula at this stage to be withdrawn past the cervical os into the vagina, as the vacuum will be lost. If the

Section 15: Major obstetric haemorrhage: miscarriage

vacuum is lost or the syringe is more than half full, empty it and then re-establish the vacuum. Do not hold the syringe by the plunger arms while the vacuum is present, as they may become unlocked and the plunger will then slip back into the syringe, pushing materials back into the uterus.

14 To ensure that all products of conception have been removed, check that red or pink foam but no tissue is seen in the cannula. The uterus will have a 'gritty' feel when the cavity is empty, and haemostasis should be achieved. The uterus may contract around the cannula. Always examine the syringe contents after the procedure. An absence of products of conception in a patient with signs of pregnancy or a positive pregnancy test and continued bleeding suggests three possibilities. Either the miscarriage was complete before evacuation, or the products are still in the uterus (in which case evacuation needs to be repeated), or there is an ectopic pregnancy. Be very careful about the third possibility.

15 If MVA is not available and a curette is used, undertake the procedure up to Step 11 above. Apply the curette with firm but controlled movements in all four quadrants of the uterus (anterior wall, left lateral, posterior wall and right lateral). The uterus will have a 'gritty' feel when the cavity is empty, and haemostasis should be achieved. If there is ongoing bleeding ensure that the cavity is empty with additional gentle curettage.

16 IV antibiotics should be given as a single dose unless there are signs of sepsis, in which case a full course of antibiotics should be given (see Section 14). All patients should be additionally treated prophylactically for Chlamydia trachomatis with either azithromycin 1 g orally once or doxycycline 100 mg orally twice daily for 7 days.

17 Anti-D immunoglobulin prophylaxis, if available and affordable, should be given to women with a Rhesus- negative blood group. In well-resourced countries, a dose of 250 IU of anti-D immunoglobulin is given before 20 weeks' gestation, and 500 IU after 20 weeks' gestation.

18 Give paracetamol, 500 mg to 1 gram orally, if needed for pain.

19 If an unsafe induced abortion is suspected, examine the woman for signs of infection and uterine, vaginal, bladder or bowel injury, and thoroughly irrigate the vagina with sterile Ringer-lactate or Hartmann's solution to remove any herbs, local medications or caustic substances before MVA is undertaken (see Section 14).

Uterine perforation

Uterine perforation may occur following evacuation of the uterus in either a medical or non-clinical setting. The risk of complications, such as infection, perforation, and damage to visceral organs such as bladder and bowel, is high where procedures are performed in non-clinical settings, and in such cases a laparotomy will be required along with high-dose intravenous antibiotics (see Section 14).

In most perforations where only the uterus has been damaged, the hole will heal spontaneously. Keep the woman under close observation for at least 48 hours.

Symptoms and signs of perforation when it has occurred in a non-medical setting

These include severe abdominal pain, vaginal bleeding, weakness, and dizziness or fainting and a high fever. On examination of the abdomen there will be guarding, rebound tenderness or a rigid abdominal wall. Frequently there will be signs of septic shock (see Section 14).

4. Complete miscarriage

Evacuation of the uterus is not needed. Observe closely for evidence of bleeding, and follow up the woman in the clinic.

Miscarriage beyond 16 weeks' gestation Spontaneous miscarriage will generally result in expulsion of the complete fetus (this is also usually the case between 12 and 16 weeks' gestation) and placenta. These may be expelled together within the gestational sac or separately after rupture of the fetal membranes.

The patient may present with bleeding, pain, loss of liquor or a history of having already expelled the fetus before arrival. The examination may reveal an effacing and/or dilated cervix, bulging membranes, or fetal parts. The cervix may also be closed and the patient

Section 15:Major obstetric haemorrhage: miscarriage

relatively asymptomatic despite a finding of fetal death on ultrasound. Ultrasound may reveal fetal cardiac activity despite evidence of an inevitable miscarriage.

Management of late miscarriage can be divided into Expectant and Medical management with Surgical management reserved for retained placental tissue after fetal expulsion and the rare cases where life-threatening haemorrhage occurs and delivery is not rapidly achievable by any other means.

If there are no signs of labour and, especially if the cervix is unfavourable, then the use of mifepristone is beneficial, but not essential if unavailable.

Expectant management

This is best reserved for patients where the delivery/miscarriage process is clearly ongoing and is likely to occur spontaneously without medical intervention. If the delivery is urgent due to the maternal condition, the patient must be monitored closely to ensure the labour is progressing so that it can be medically augmented promptly if required.

Medical management

If spontaneous delivery is not expected or delayed then delivery can be expedited medically. If chorioamnionitis is suspected then delivery is urgent and induction should be started without delay and the patient treated appropriately with high dose IV antibiotics and other measures as indicated during the process.

The patient needs to be assessed for evidence of infection, bleeding or other associated disorders and treated accordingly.

The following investigations should be performed as a minimum: blood group and cross match, Hb, malaria RDT+/- malaria smear, urine analysis for possible infection.

If there are no signs of labour and especially if the cervix is unfavourable, then the use of mifepristone is beneficial if available but can be omitted. If the delivery is urgent then either the interval between mifepristone and misoprostol treatment can be reduced or they can be administered together.

- 1 Obtain intravenous access
- 2 Give mifepristone 200 micrograms orally (if available)
- 3 Observe the patient in hospital for a period of 36 to 48 hours
- 4 If mifepristone is not available give misoprostol 100 micrograms (200 micrograms if <27 weeks) vaginally or orally every 3 hours up to a total of 5 doses. Oral administration is advised following initial vaginal installation of the first dose of misoprostol and assessment, especially, in the presence of ruptured membranes, to reduce the risk of ascending infection. A sterile technique must be followed whenever vaginal assessments are performed.
- 5 Review by a doctor if delivery has not occurred within 3 hours of the final (5th dose) of misoprostol.

Note: The dose of misoprostol should not be higher than 100 microgram beyond 27 weeks' gestation and no higher than 50 microgram in women at higher risk of perforation e.g. grand-multiparae and after previous Caesarean section.

If mifepristone or misoprostol are not available, infuse oxytocin, 40 units in 1 litre of IV fluid (Ringer-lactate or Hartmann's solution) over 4 hours until expulsion of the products of conception occurs.

Following delivery, oxytocin 10 IU intramuscular should be given and the patient monitored for bleeding.

If the placenta is not expelled with or immediately following the fetus, retained tissue is likely even if the placenta is eventually expelled. Have a low threshold for exploration and evacuation.

Where gestation is around 24 weeks it may be safer to remove the placenta manually as after a term pregnancy. If not possible then MVA/curette can be used.

Follow-up and management after a miscarriage, especially where evacuation has occurred.

Uncomplicated evacuations may not require follow-up. The patient should be encouraged to eat and drink and be mobile. She should be aware of the potential complications of miscarriage that include: retained tissue (sometimes requiring repeat evacuation), infection and haemorrhage. She should be advised to seek help if there are any symptoms suggestive of these complications, such as ongoing bleeding beyond 2 weeks, very heavy bleeding at any time, severe abdominal pain, offensive-smelling vaginal secretions, fever or malaise.

Rigors or fainting potentially indicate severe complications, and the woman must return immediately to the hospital if these symptoms occur. Family planning must be discussed, and the woman advised to avoid pregnancy for at least 3 months.

In the case of mid-trimester miscarriages (>12 weeks' gestation), consideration should be given to the cause of the miscarriage as it is less common at this time and more likely to be secondary to a treatable factor. As a minimum, malaria (where endemic), syphilis and urinary tract infection should be excluded or treated.

Antepartum haemorrhage

Bleeding after potential viability from 24–28 weeks' gestation. The main causes are placenta praevia, placental abruption, and bleeding from cervical or vaginal lesions.

Bleeding from the cervix is common but is not usually heavy. It may be due to rapid cervical dilatation, cervical ectropion or polyps. Ectropions and polyps may become more vascular and friable in pregnancy, predisposing to bleeding. Endo-cervical and vaginal infections such as Chlamydia, Neisseria, Trichomonas and Candida can give rise to bleeding. Cervical carcinoma is another cause of APH.

Speculum examination should be performed in order to visualise the cervix and help to assess the likely cause.

TABLE 15.1 Causes of major (> 500 mL) or massive (> 1500 mL) APH

Symptoms	Clinical signs	Diagnosis	Treatment
Severe constant abdominal pain	Shock	Placental abruption	Call for surgical and anaesthetic help
Light or heavy vaginal bleeding (or non-visible bleeding in concealed abruption)	Tense and tender uterus on abdominal examination		Oxygen
	Fetal distress or absent fetal heart rate		Left lateral tilt
Reduced or absent fetal movements			IV fluid boluses for shock + blood
Dizziness			Cross-match 4 units of blood and freeze-dried plasma if available; transfuse prior to delivery if possible, to try to correct any clotting abnormality
Shortness of breath			
Confusion			Deliver the fetus as soon as possible if viable, either by inducing labour or by Caesarean section

Section 15:Major obstetric haemorrhage: antepartum haemorrhage

Symptoms	Clinical signs	Diagnosis	Treatment
<p>Vaginal bleeding that may be light or very heavy</p> <p>Bleeding can be precipitated by intercourse or vaginal examination</p> <p>No pain</p>	<p>Soft uterus</p> <p>Presenting part may be higher than expected</p> <p>Malpresentation is more common</p> <p>Fetus may be distressed, non-viable or uncompromised with normal movements and normal fetal heart rate pattern</p> <p>Ultrasound will show placenta praevia</p> <p>Do not undertake digital vaginal examination, as this can puncture the placenta and precipitate massive bleeding which may be fatal</p> <p>Shock may be present, depending on how heavy the bleeding is and for how long it has been occurring</p>	Placenta praevia	<p>Call for surgical and anaesthetic help</p> <p>Treat shock if present, including the lateral tilt position (see above)</p> <p>Do not undertake digital vaginal examination, as this can puncture the placenta and precipitate massive bleeding which may be fatal</p> <p>If preterm and not bleeding too heavily, give steroids, admit for bed rest and only go for Caesarean section if there is a further bleed</p> <p>Cross-match ideally 4 units of blood</p>
<p>Continuous abdominal pain</p> <p>Vaginal bleeding that may be light or heavy</p> <p>History of a previous Caesarean section or other surgery on the uterus</p>	<p>Shock (especially an increasing heart rate)</p> <p>Tense, distended and tender abdomen</p> <p>Easily palpable fetal parts</p> <p>Absent fetal movements and heart sounds</p> <p>Malpresentation – transverse lie</p> <p>Signs of cephalo-pelvic disproportion</p> <p>Scar from previous surgery</p> <p>Haematuria</p>	Ruptured uterus	<p>Call for surgical and anaesthetic help</p> <p>Treat shock if present</p> <p>Cross-match ideally 4 units of blood</p> <p>Prepare operating theatre for laparotomy while resuscitating patient</p> <p>Stoptyocin infusion if in place</p>
Heavy vaginal and other bleeding	<p>Bleeding from sites in addition to the vagina</p> <p>Signs of other conditions that may be responsible, such as:</p> <ul style="list-style-type: none"> • placental abruption • pre-eclampsia or eclampsia (high blood pressure and proteinuria) • retained dead fetus • septicaemia, including intrauterine sepsis • incompatible blood transfusion • amniotic fluid embolism 	Coagulation failure	<p>Fresh blood transfusion</p> <p>Blood products such as platelets, fresh-frozen plasma and cryoprecipitate if available</p> <p>Antibiotics if appropriate</p>

Section 15: Major obstetric haemorrhage: antepartum haemorrhage

Symptoms	Clinical signs	Diagnosis	Treatment
Vaginal bleeding that is light Bleeding can be precipitated by intercourse or artificial rupture of membranes No pain	Fetal distress or death	Vasa praevia (placental blood vessels lying in the membranes and in front of the baby's head)	If diagnosed by ultrasound before labour, plan for Caesarean section

Diagnosis

Important points in history taking include the following:

- Is the bleeding provoked or unprovoked?
 - Bleeding due to placenta praevia is likely to be unprovoked. However, bleeding may be precipitated by intercourse or vaginal examination.
 - Abruption is more likely after abdominal trauma.
 - Intercourse may cause bleeding from cervical or vaginal lesions.
- Is the bleeding painful or painless?
 - Bleeding due to placenta praevia is usually painless.
 - Bleeding due to placental abruption is initially painless, but as it continues contractions will occur and eventually become tonic with constant severe pain and a woody feel to the uterus.
- Is it fresh or old blood?
- Is the bleeding light or heavy?

Management of APH

- ABC and resuscitation if needed.
- Monitor vital signs.
- Gain IV access and give fluid resuscitation if needed.
- Send blood for urgent haemoglobin, grouping and cross-matching, as well as Kleihauer test (if available).
- Catheterise the patient.
- Perform an abdominal examination: assess uterine tone, tenderness, presence of contractions, auscultation of the fetal heart.
- Do a speculum examination: assess for vaginal and cervical lesions, and severity of bleeding. If the placental site is unknown, an ultrasound scan should be performed first. If not possible, great caution must be taken as bleeding from a placenta praevia may be exacerbated by vaginal assessment.
- Listen to the fetal heart.

Insert a venous cannula if any of the following are present: active bleeding, contractions, tenderness or increased tone of the uterus.

If the patient is shocked, proceed to assessment and resuscitation (see below).

Investigations: haemoglobin, platelet count, clotting tests, urea and electrolytes, liver function tests. Cross-match 4 units if there is major (> 500 mL) or massive (> 1500 mL) haemorrhage or if the bleeding is rapid; group and save if there is loss of < 500 mL and the bleeding is not ongoing.

Perform a Kleihauer test if the woman is Rhesus negative or if there is major abdominal trauma.

Management of the different causes of APH

Placenta praevia

Placenta praevia is an abnormally situated placenta in the lower uterine segment. It presents with painless bleeding, often with no precipitating factor. Bleeding may be heavy and is bright red.

Prevention and protection

- Early detection of placenta praevia is very important to prevent serious bleeding.
- Any bleeding during pregnancy must be investigated by an ultrasound scan.
- Mothers with placenta praevia should have immediate access to an obstetric unit with facilities for Caesarean section.
- Mothers over 28 weeks pregnant with a placenta praevia and bleeding should stay in hospital until delivery by Caesarean section, or live very near to an obstetric unit that can perform Caesarean section.

Never allow a digital vaginal examination to be undertaken on a patient with known or suspected placenta praevia, as it can precipitate massive vaginal bleeding.

Careful speculum examination can help to exclude bleeding from the cervix or vagina but, if placenta praevia is known to be present, then undertake with extreme caution, ideally in the operating theatre.

Placental abruption

- Placental abruption refers to the premature separation of a normally situated placenta. The bleeding may be concealed or revealed, or mixed. It may be partial or complete (if complete, the fetus will be dead).
- The characteristic initial symptom is painless bleeding, which can be concealed or be associated with vaginal bleeding. As abruption becomes worse, contractions will occur and eventually become tonic with constant severe pain and a woody feel to the uterus. At this stage there will usually be shock, severe abdominal pain, and tenderness over the uterus. In early bleeding the uterus may still be soft to touch, but as the bleeding progresses it has a hard 'woody' feel due to uterine contraction. It may be difficult to palpate the fetal parts, the uterus may be large for dates and there may be signs of fetal distress or intrauterine fetal death. It is possible for large bleeds to be asymptomatic and even small bleeds can occasionally result in fetal death.
- Disseminated intravascular coagulation (DIC) is a common complication. A large placental abruption can occur without any visible vaginal blood loss (concealed haemorrhage).
- Remember that blood loss is invariably underestimated. Young healthy women will compensate and maintain their blood pressure until they lose around 20% of their circulating volume.
- The main risk factor for placental abruption is a previous abruption. Increased maternal age, maternal hypertension and trauma also increase the risk.

Ruptured uterus

Uterine rupture is full-thickness separation of the uterine muscle and the overlying visceral peritoneum, sometimes associated with extrusion of the fetus, placenta or both into the abdominal cavity.

- Bleeding from a ruptured uterus can occur either before (rare) or after the onset of labour, although the majority occurs during labour itself.
- Risk factors for rupture include obstructed labour due to cephalo-pelvic disproportion, multiparity (especially grand-multiparity), previous uterine surgery (including myomectomy and Caesarean section), and use of uterotonics (including misoprostol and oxytocin).
- A previous Caesarean section scar may rupture during labour. However, obstructed labour even without a uterine scar, particularly in a woman of high parity, may also cause uterine rupture.
- Excessive doses of oxytocin during labour can precipitate uterine rupture and oxytocin should be used with particular caution in multiparous women, especially if it is

Section 15:Major obstetric haemorrhage: antepartum haemorrhage

being used to augment rather than induce labour. Any mother who is receiving this drug during labour should be assessed closely for contraindications before its administration, and should not be left alone.

- Extra careful consideration must be given to the administration of oxytocin in labour to a woman with a uterine scar, because of the increased risk of uterine rupture. This applies to women with previous myomectomy as well as to those with a previous Caesarean section.
- In any setting, including resource limited settings, women with uterine scars should only receive oxytocin before delivery when a high level of supervision is available.
- Ideally, always use a burette in-line giving set to administer IV oxytocin, to avoid over-dosage.
- Rupture of the uterus can also occur following violence or major trauma.

Symptoms and signs of ruptured uterus

- Characteristically there is pain and tenderness over the uterus, with blood loss vaginally and cessation of contractions.
- Uterine rupture usually presents with shock, which is partly due to blood loss and partly due to increased vagal nerve stimulation (so there may be a slow pulse rather than a fast one). The baby is usually dead or has severe fetal distress.
- There may be a change in the nature of the pain in labour, from severe intermittent pain to a constant pain.
- Vaginal bleeding may or may not be present. Bleeding from a ruptured uterus can fail to drain vaginally due to an impacted fetal head, and usually the majority of bleeding is intra-abdominal in this situation.
- Maternal shock can be made worse by dehydration, exhaustion and acidosis if prolonged obstructed labour has preceded the rupture.
- The abdomen is tender to palpation, and the fetal parts can be too easily palpable.
- On vaginal examination, the presenting part may be high or impacted; the fetal head may have retreated into the uterus.
- There may be a marked maternal bradycardia (< 60 beats/minute) due to increased vagal tone.
- The main differential diagnosis is placental abruption.

Management of ruptured uterus

- 1 Suspect uterine rupture in any patient with risk factors such as previous Caesarean section.
- 2 Primary assessment, resuscitation and emergency treatment for shock (see below).
- 3 Call the obstetrician and anaesthetist.
- 4 Obtain consent and prepare the operating theatre.
- 5 Perform urgent laparotomy.
- 6 Give prophylactic IV antibiotics (ampicillin, gentamicin and metronidazole).

Vasa praevia

- This is an uncommon but life-threatening condition for the fetus. In vasa praevia, fetal blood vessels run over or close to the cervix beneath the presenting part, unprotected by Wharton's jelly or placental tissue. These vessels are vulnerable to laceration and compression, most commonly at the time of delivery.
- Fetal or neonatal death can occur due to exsanguination or asphyxiation.
- Antenatal diagnosis can be made only by skilled ultrasound examination. Caesarean section is then needed to reduce the high mortality rate.

Failure of blood clotting

Section 15: Major obstetric haemorrhage: antepartum haemorrhage

This may be due to a pre-existing coagulation problem, or to complications of the pregnancy causing excessive bleeding and disseminated intravascular coagulation (DIC) (consumption of the clotting factors).

Obstetric causes include the following:

- placental abruption
- pre-eclampsia or eclampsia
- retained dead fetus
- septicaemia, including intrauterine sepsis
- incompatible blood transfusion
- amniotic fluid embolism.

Primary assessment and resuscitation and secondary assessment and emergency treatment for APH with shock

The aims are as follows:

- to prevent shock and disseminated intravascular coagulation
- to achieve intact fetal survival if viability is possible in the circumstances.

Call for experienced obstetric and anaesthetic assistance (if available) and ensure that the operating theatre is ready

Airway

- Open the airway using chin lift or jaw thrust techniques if it is closed or partially obstructed. If there is an improvement, keep the airway open using either an assistant or an oropharyngeal airway if the patient is unconscious and this is tolerated without gagging.
- Suction if necessary.
- The airway may need to be secured by intubation using experienced senior help (if available).

Breathing

- Normal respiratory rates in pregnancy at rest are 15–20 breaths/minute. Tachypnoea can be due to acidosis.
- Provide high-flow oxygen by facemask with reservoir bag for adequate spontaneous respiration regardless of SaO₂. This increases fetal oxygen delivery as well as improving maternal tissue oxygenation.
- If ventilation is inadequate, especially when there is a depressed conscious level (P or U on the AVPU scale), airway and breathing should be supported by bag-valve-mask inflations with high-flow oxygen, and experienced senior help should be called, including an anaesthetist if available.

Circulation

- Normal heart rates in pregnancy at rest are 60–90 beats/minute.
- Normal blood pressure in a pregnant mother at rest is 95/60–135/85 mmHg.
- Remember to put the patient in the left lateral tilt position and elevate the legs.
- Monitor the heart rate and blood pressure, and reassess regularly. Aim to keep the heart rate at ≤ 110 beats/minute and the systolic blood pressure at ≥ 100 mmHg.

Recognise the signs of hypovolaemic shock. These include the following:

- tachycardia
- tachypnoea
- cold, pale, sweaty and possibly cyanosed skin
- alteration of mental state: confusion or unconsciousness
- fall in urine output to less than 30 mL/hour
- narrowed pulse pressure
- hypotension (this is a late sign).

Remember that young healthy women can lose a lot of blood before they become shocked, especially if it is a slow trickle rather than a sudden large loss.

Restore circulating volume

- Put the mother in the left lateral tilt to minimise the effects of compression of the inferior vena cava or aorta. Lateral tilt can be achieved by using a pillow, blanket or rolled

Section 15: Major obstetric haemorrhage: antepartum haemorrhage

up towel. A wedge may be used during obstetric procedures. Assistants can also manually displace the uterus.

Figure 15.4 Manual displacement of uterus and left lateral tilt



- Gain IV access and take blood for full blood count, cross-matching and blood clotting measurement. If IV access is not possible, consider intra-osseous needle insertion.
- Use a short wide-bore IV cannula if possible, either 14G (usually orange) or 16G (usually grey).
- External jugular vein access is a good option if peripheral access is impossible. Long saphenous vein cut-down may also be considered. If adequately trained personnel are available, central venous access, ideally via the internal jugular vein, can be extremely helpful. If access is not possible, consider intra-osseous needle insertion (see Section 9).
- Try to obtain two vascular access sites to give large volumes quickly, and in case one line is lost. Do not waste time, and as soon as the first IV cannula is in place, give an IV fluid bolus.
- Take blood for cross-matching (ideally 4–6 units), full blood count, renal function tests (if available), and blood clotting.
- Elevate the legs.
- Give an initial IV bolus of 500 mL to 1 litre of Ringer- lactate or Hartmann's solution as fast as possible using a three-way tap and 20- to 50-mL syringes to push in as rapidly as possible. If reassessment of the circulation shows little or no improvement, then a further 500 mL should be given and followed by blood transfusion as soon as this is available. (A normal adult has a circulatory blood volume of 5 litres, and during pregnancy this increases by 40% to 7 litres.)
- Apply an anti-shock garment (if available) to help maintain adequate central circulation and provide time for urgent definitive treatment to be implemented.

Tranexamic acid can be of benefit in patients with continued bleeding. The loading dose is 1 gram over 10 minutes followed by an IV infusion of a further 1 gram over 8 hours. The slow IV bolus dose is given by injecting 1 gram of tranexamic acid into a 100-mL bag of 0.9% saline and letting it run through over about 10–20 minutes (the exact timing is not crucial). The 8-hour infusion is given by injecting 1 gram of tranexamic acid into a 500-mL bag of 0.9% saline and giving it over 8 hours (approximately 60 mL/hour).

- Ensure adequate transfusion; the best way to resuscitate the fetus is to resuscitate the mother. Inadequate transfusion is common, especially in cases of placental abruption.
- A central venous pressure (CVP) line can aid the decision as to whether more fluid is needed. However, insertion should not delay initial resuscitation, and must be undertaken by a competent person. If peripheral access is inadequate, this route may be used for volume replacement. If DIC is established, CVP insertion is more hazardous and the subclavian vein should be avoided, because it is not externally compressible.
- If shock is accompanied by a bradycardia of less than 60 beats/minute (e.g. in a patient with a ruptured uterus), give atropine 500–600 micrograms as an IV injection.

Blood products

- Fresh whole blood is preferable for managing obstetric haemorrhage.

Section 15:Major obstetric haemorrhage: antepartum haemorrhage

- Use cross-matched blood where available except in an immediately life-threatening emergency, when group- specific blood should be used, as cross-matching may take up to an hour.
- The patient's blood group should be established during pregnancy, to facilitate the provision of blood when it is needed.
- All large-volume infusions should be warmed. In particular, do not infuse cold fluid through a central venous line. The patient should also be kept warm, as hypothermia will exacerbate poor peripheral perfusion, acidosis and coagulation abnormalities. Any benefits of blood filters may be outweighed by their deleterious effect on the speed of transfusion. A good way of warming blood is to place the cold bag under the clothes of a relative next to their skin until the blood is warmed.

Identify and treat any blood clotting disorders.

- Assess bedside clotting: coagulopathy is defined as failure of a clot to form after 7 minutes, or formation of a soft clot that breaks easily (see page XX for details of whole blood clotting time measurement). Suspect and aggressively treat blood clotting disorders using warmed fresh blood, platelets (if the platelet count is $< 50\,000 \times 10^9$), fresh-frozen plasma (15 mL/kg) and cryoprecipitate as appropriate and if available.
- Freeze-dried plasma is being used in the military in adverse conditions, as it is shelf stable for 2 years and easily reconstituted with sterile water within minutes. It would be a very useful addition to the emergency stores in resource-limited countries where the use of fresh or frozen plasma presents major storage problems.

Urinary catheterisation is needed for measurement of hourly urine output. Aim for a rate of more than 30 mL/ hour.

When the patient is stable, move her to a place where there is adequate space, light and equipment to continue resuscitation and treatment.

Fetal assessment

When the mother has been resuscitated:

- listen for fetal heart sounds
- if significant haemorrhage has occurred and the fetus is considered viable after birth in the prevailing circumstances, consider immediate delivery only if this is safe for the mother.

Anaesthetic issues

Cardiovascular instability is a relative contraindication to spinal anaesthesia.

- Rapid sequence induction agents with minimal peripheral vasodilator action, such as ketamine 1–2 mg/kg, should be considered (but may cause an increase in BP in pre-eclampsia)
- Adrenaline and atropine should be readily available in case cardiovascular collapse occurs on induction. Ventilation with high oxygen concentrations may be needed until the bleeding is controlled.
- Volatile agents have been associated with increased blood loss due to their relaxant effects on uterine muscle. Anaesthesia should be maintained with IV agents (usually ketamine) if uterine atony is a problem.
- If spinal anaesthesia is used, compensatory lower limb vasoconstriction is abolished, so profound hypotension may occur.

Delivery options

- Diagnose and treat the source of bleeding.
- Perform Caesarean section for major abruption or placenta praevia.
- Induce labour if the fetus is dead, there is no placenta praevia, the mother is stable and there is no significant ongoing blood loss.
- Urine output should be monitored hourly and Caesarean section considered if labour does not become established fairly quickly. The longer the dead fetus remains in utero, the greater the likelihood of development of DIC.

Section 15: Major obstetric haemorrhage: antepartum haemorrhage

- Expect and be prepared for massive postpartum haemorrhage, whether the baby is delivered vaginally or by Caesarean section. In cases of severe APH that require surgery, discuss the possibility of hysterectomy.

APH uses up the clotting factors and platelets, leaving the woman in danger if PPH follows soon afterwards.

If no safe operating theatre facilities for Caesarean section are present, give oxygen, transfuse fresh blood and transfer the patient as soon as she is safe and stable. Ensure that IV fluids are in place, catheterise the patient, and ensure that she is nil by mouth.

Monitoring

Essential monitoring should include pulse rate and volume, blood pressure, respiratory rate, oxygenation (SaO₂ if available), temperature and fluid balance (with a urinary catheter). Regular checks of the haematocrit, clotting studies and blood gases will help to guide resuscitation.

Figure 15.5 Pathway of care for massive APH

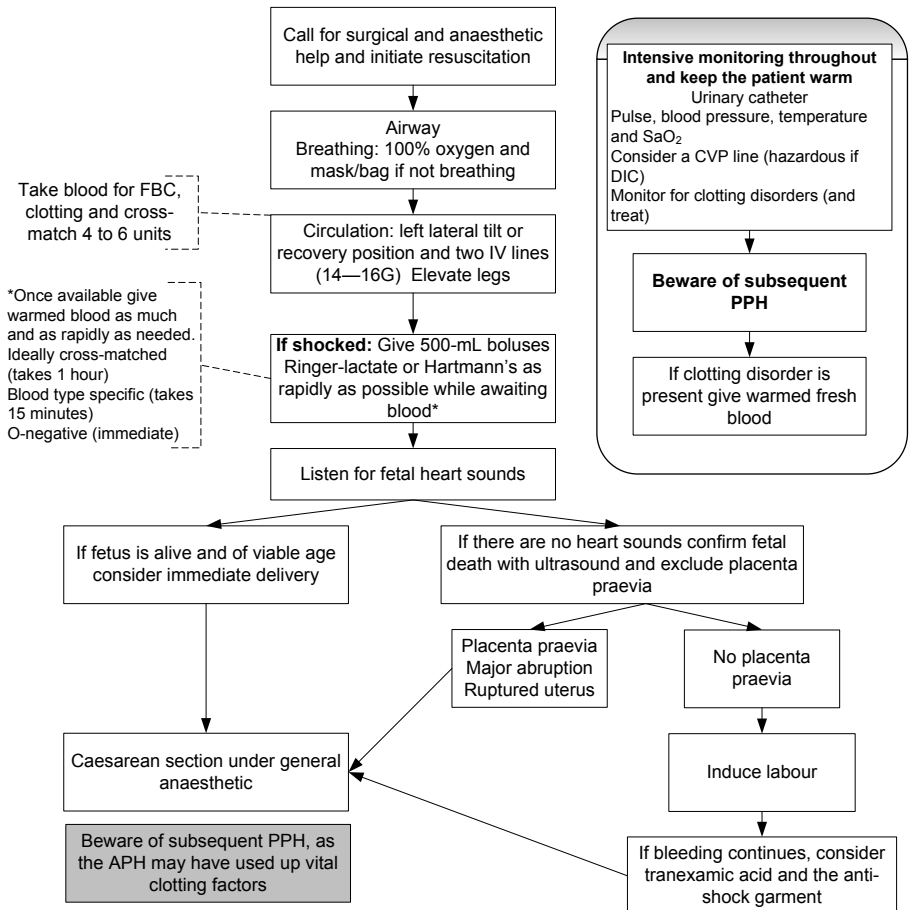

Section 15:Major obstetric haemorrhage: postpartum haemorrhage

Postpartum haemorrhage

A blood loss of more than 500 mL from a vaginal birth and more than 1 litre after a Caesarean section.

Estimates of blood loss are inaccurate and tend to be low, often around half the actual loss. Blood is mixed with amniotic fluid and sometimes with urine. It is also dispersed on sponges, towels and linen, in buckets and on the floor.

The importance of any given volume of blood loss varies depending on the mother's haemoglobin level. A mother with a normal haemoglobin level will tolerate blood loss that would be fatal for an anaemic woman. This is why **it is essential to ensure that every woman who reaches labour has an adequate haemoglobin level.**

Bleeding may occur at a slow rate over several hours, in which case the condition may not be recognised until the mother is shocked.

Prevention of PPH

Active management of the third stage of labour is essential for prevention of PPH, and it consists of four possible interventions:

- 1 a prophylactic uterotonic drug after delivery, after checking that there is not a second twin present.
- 2 early cord clamping and cutting
- 3 controlled cord traction
- 4 uterine massage after delivery of the placenta.

A prophylactic uterotonic drug after delivery is the most important intervention:

Oxytocin 10 IU IM or, especially if the mother is shocked, 5 IU by slow (over 1–2 minutes) IV injection is the first choice because it causes uterine contractions to prevent atony rapidly and with minimal adverse effects. Atony is the most common cause of PPH (around 80% of cases). Where oxytocin is unavailable or does not work, other uterotonic drugs should be used, including:

- o **Ergometrine** 200 or 500 micrograms IM
- o **Misoprostol** 600 micrograms sublingually or orally if the mother is fully conscious 800 micrograms rectally if the mother is drowsy or unconscious.

All uterotonic drugs should be given within 1 minute of the complete birth of the fetus, to aid separation of the placenta by enhancing uterine contractions and reducing the risk of bleeding from an atonic (relaxed) uterus. **It is essential that, before giving such drugs, you are certain there is not another fetus in the uterus.**

Ensure that both oxytocin and ergometrine are protected from heat damage by paying close attention to the cold chain and their storage, otherwise they may not be effective. Ideally oxytocin should be stored in a fridge, but it can be kept at 15–30°C for 3 months. Oxytocin must never be frozen. Ergometrine should always be stored in a fridge at 2–8°C. Misoprostol can be stored at ambient temperature.

Ergometrine is contraindicated in heart disease, hypertension, pre-eclampsia and eclampsia, as it raises the blood pressure by vasoconstriction, which increases the risk of cerebrovascular accidents.

Early cord clamping and cutting

This is not an essential part of the active management of the third stage of labour, and is no longer recommended unless the infant needs resuscitation.

Controlled cord traction

This is optional where delivery is undertaken by a skilled birth attendant, but contraindicated if a skilled attendant is not available.

Strong uterine massage

This should **always** be undertaken immediately after delivery of the placenta until the uterus is contracted and remains so. Check the state of contraction of the uterus every 15

Section 15:Major obstetric haemorrhage: postpartum haemorrhage

minutes for 2 hours, and repeat the massage if at any time the uterus becomes soft and relaxed.

In order to prevent PPH during or after Caesarean section, the use of oxytocin plus cord traction is recommended in preference to manual removal of the placenta.

How to manage the third stage of labour if uterotonic drugs are not available

Unfortunately it is not uncommon for hospitals in low resource countries to run out of uterotonic drugs. In this avoidable and dangerous situation, expectant and/or physiological management should be undertaken.

- 1 Place the baby on the mother's breast.
 - 2 Leave the cord alone.
 - 3 Observe for the following signs of placental separation:
 - a small gush of blood
 - a lengthening of the cord at the introitus
 - the mother feeling uncomfortable, feeling a contraction and wanting to 'bear down'.
- Most placentas separate within 1 hour of birth. If this does not happen, seek help.
- 4 Deliver the placenta.
 - Sit the mother upright.
 - Encourage her to bear down with a contraction (only after placental separation).
 - Catch the placenta. If membranes are dragging behind it, gently twist a few turns and with slight traction and an up-and-down movement deliver the placenta plus membranes.

Controlled cord traction should not be undertaken prior to the separation of the placenta in the absence of uterotonic drugs.

TABLE 15.2 *Diagnosis of causes of PPH*

Symptoms	Signs	Possible diagnosis
Immediate heavy bleeding after birth	Uterus soft and not contracted	Atonic uterus
Immediate heavy bleeding after birth	Uterus contracted	Trauma to cervix, vagina or perineum
Bleeding which may be light if clot is blocking cervix	Placenta not delivered within 30 minutes of birth	Retained placenta
Bleeding which is usually light but continues for many hours	Portion of placenta missing Uterus contracted	Retained placental parts
Bleeding for more than 24 hours	Portion of placenta missing Foul-smelling lochia may be present Fever may be present Severe anaemia	Retained placental parts with or without infection
Lower abdominal pain of varying intensity Immediate but usually light bleeding	Uterus not felt on abdominal palpation Inverted uterus may be seen at vulva Bradycardia may be present Shock	Inverted uterus

Section 15:Major obstetric haemorrhage: postpartum haemorrhage

Symptoms	Signs	Possible diagnosis
<p>Usually during labour there has been a change from intermittent labour contractions to a constant pain which may become less after rupture has occurred</p> <p>Sometimes an oxytocin drip is in place</p> <p>Vaginal bleeding which may be light or heavy</p> <p>History of a previous Caesarean section or other operation on the uterus</p>	<p>Shock</p> <p>Abdominal distension</p> <p>Tenderness over uterus</p>	<p>Ruptured uterus (more likely before delivery of the baby)</p>

Monitoring after the placenta has been delivered by active or expectant management

- 1 Monitor the blood pressure, pulse and state of the uterus (i.e. whether it is contracted) every 15 minutes for 2 hours after delivery of the placenta.
- 2 Examine the placenta for completeness.

Causes of PPH

Primary PPH

This occurs within 24 hours of birth, and in around 80% of cases is due to uterine atony. Remember the 4 T's: Tone, Tissue, Trauma, Thrombin.

- Tone: atonic uterus – failure to contract after birth.
- Tissue: retained placenta or placental fragments.
- Trauma: ruptured uterus, or trauma to the cervix, vagina or perineum.
- Thrombin: clotting defects, notably disseminated intra-vascular coagulation (DIC).

Remember also the following:

- Haemorrhage may be concealed within the uterus or within the abdominal cavity.
- A ruptured uterus can cause concealed bleeding, as can bleeding following Caesarean section.
- An inverted uterus is associated with PPH.
- Any degree of PPH is dangerous if there has been severe anaemia before delivery.

Secondary PPH

Secondary PPH (occurring from 24 hours or more after delivery up to 6 weeks after birth) is commonly associated with retained products of conception that undergo necrosis, become infected and prevent involution (sustained contraction) of the uterus. A fever suggests an infective component.

Factors that predispose to PPH

These include the following:

- previous APH
- retained products of conception
- trauma to the uterus or birth canal (e.g. from instrumental delivery)
- uterine over-distension (e.g. due to multiple pregnancy or polyhydramnios)
- grand multiparity
- prolonged labour.

Management of large PPH

First call for help (this must include a surgeon and an anaesthetist), palpate the uterus and massage it strongly and immediately, as it is most likely that an atonic uterus is the cause.

Procedures for stopping haemorrhage must be started immediately and then undertaken in parallel with IV fluid resuscitation.

Section 15:Major obstetric haemorrhage: postpartum haemorrhage

Airway and breathing

- Ensure that the airway is open and remains so.
- Provide high-flow oxygen through a facemask with reservoir bag if there is adequate spontaneous respiration.
Give 100% oxygen (using a mask with reservoir and high flow rate).
- For patients with inadequate ventilation or depressed conscious level (P or U on the AVPU scale), respiration should be supported with oxygen via a bag-valve-mask, and experienced senior help should be summoned (if available).

Circulation

Primary assessment denoting shock

- Fast, weak pulse (≥ 100 – 110 beats/minute). Normal heart rates in a pregnant mother at rest are 60–90 beats/ minute. Tachycardia is an early sign of shock.
- Low-volume (weak) pulse.
- Pallor (especially of the inner eyelid, palms or around the mouth).
- Sweatiness or cold clammy skin.
- Prolonged capillary refill time (> 3 seconds).
- Rapid breathing (> 30 breaths/minute). Normal respiratory rates at rest are 15–20 breaths/minute; tachypnoea can be due to acidosis.
- Low blood pressure (systolic pressure < 90 mmHg) is a very late sign. Healthy women and girls can maintain a normal or even high blood pressure while losing large volumes of blood.
- Nausea with or without vomiting.
- Anxiety, confusion or unconsciousness.
- Reduced urine output (< 30 mL/hour). Urinary catheterisation is needed for measurement of hourly urine output if the patient is shocked (normal output is > 30 mL/hour).

The aim with all treatments is for a pulse rate of ≤ 100 – 110 beat/minute and a systolic blood pressure that is ≥ 90 – 100 mmHg and stable in a woman who is fully alert and has a urine output of ≥ 30 mL/hour.

Measures to stop further haemorrhage due to uterine atony

1. Rubbing up a contraction

Poor contraction of the uterus after delivery is the commonest cause of PPH. Rub up a contraction of the uterus (do not just pinch the skin).

Abdominal massage of the uterus

If the uterus is atonic, a contraction may be rubbed up by abdominal massage.

- Massage the fundus in a circular motion with the cupped palm of your hand until it is contracted.
- When it is well contracted, place your fingers behind the fundus and push down in one swift action to expel clots.

2. Uterotonic drugs

Give 10 IU of oxytocin IM or 5 IU IV slowly, especially if the patient is already shocked, and repeat after 5 minutes if they are still bleeding and/or the uterus is not contracted. This is the drug of first choice.

Oxytocin starts to work 2–3 minutes after IV injection, but has a relatively short duration of action, and an infusion will be needed to maintain a contracted uterus. Following an oxytocin bolus, give an IV infusion of oxytocin 40 IU in 500 mL (60 drops/minute with a standard IV giving set where 20 drops = 1 mL) or 1 litre (120 drops/minute) of Ringer-lactate or Hartmann's solution over 4 hours.

Side effects include hypotension (due to vasodilatation when given as a rapid IV bolus) and fluid retention.

If the mother does not have eclampsia, pre-eclampsia or hypertension, ergometrine 200 to 500 micrograms IM **in addition** may help uterine contraction.

Section 15:Major obstetric haemorrhage: postpartum haemorrhage

If the first dose of oxytocin does not stop bleeding within a few minutes, give misoprostol. It is given rectally as 4 × 200 microgram tablets or pessaries (800 micrograms in total) or, if the patient is conscious, orally as 3 × 200 micro-gram tablets or 2 × 200 micrograms of powder sublingually.

Ergometrine, either as part of Syntometrine (oxytocin 5 IU and ergometrine 500 micrograms IM) or alone, is contraindicated in pre-eclampsia, as its hypertensive action increases the risk of convulsions and cerebrovascular accidents.

3. Urinary catheterisation

This may help the uterus to contract.

4. Bimanual uterine compression

If heavy PPH continues despite uterine massage, and with the placenta already delivered, this procedure can be very effective. If the placenta is still in place priority should be given to removing it as soon as possible.

- You must wear sterile or disinfected gloves (ideally long versions to the elbow).
- Introduce your right hand into the vagina, clench your fist with the back of your hand positioned posteriorly and your knuckles in the anterior fornix.
- Place your other hand on the abdomen behind the uterus and squeeze the uterus firmly between both hands.
- Continue compression until the bleeding stops (i.e. there is no bleeding when compression is released), and the uterus is contracted.

Although this procedure is painful, it is highly effective and can significantly reduce or even successfully treat uterine haemorrhage. Therefore, if the bleeding is profuse, and the number of staff attending the patient allows, it is a good idea for one member of the team to commence bimanual compression while uterotonic drugs are prepared and given, and initial fluid resuscitation commenced.

Figure 15.6 Bimanual compression

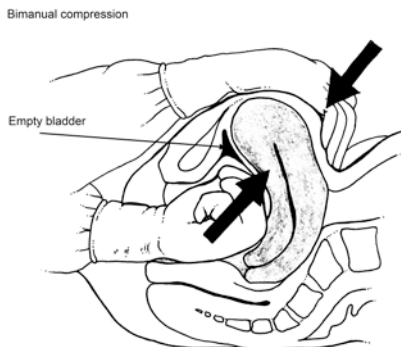

5. Aortic compression

If bleeding still persists, apply aortic compression.

- Apply downward pressure with a closed fist (with your thumb outside the fist) over the abdominal aorta directly through the abdominal wall.
- The point of compression is just above the umbilicus and slightly to the left.
- Aortic pulsations can be felt through the anterior abdominal wall in the immediate postpartum period. Press the aorta down on to the vertebral column.
- With your other hand, palpate the femoral pulse with four fingers parallel to and just below the inguinal ligament to check the adequacy of compression.

Section 15: Major obstetric haemorrhage: postpartum haemorrhage

- If the pulse is palpable during compression, the pressure exerted by the fist is inadequate.
- If the femoral pulse is not palpable, the pressure exerted is adequate.

Figure 15.7 Aortic compression

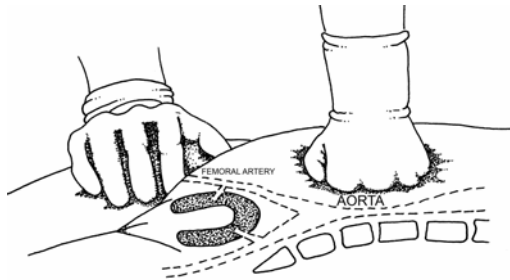

Continue until the bleeding stops. If it does not stop, continue to exert pressure while transferring the mother to a facility where expert help is available.

6. Uterine tamponade

Uterine packing with a hydrostatic balloon such as a Rusch balloon or condom over a simple in–out urinary catheter can help to control haemorrhage from an atonic uterus that does not respond to the above measures. The uterus may also be packed with a sterile pack or gauze, although it is important to ensure any gauze used is tied together, counted carefully, and extended into the vagina to facilitate removal.

A condom catheter, which is inserted into the uterus as a sterile procedure and filled with 250–500 mL of sterile Ringer-lactate or Hartmann's solution or 0.9% saline to create a uterine wall tamponade, is an effective way of stopping uterine bleeding that is continuing despite the use of uterotonic drugs and procedures (see Figure 15.8). It is important to check that the balloon is fully inside the uterus as it is inflated, and to take measures to ensure that it does not become displaced into the vagina. Packing the vagina with a sterile pack or gauze swab can do this.

Leave the balloon in position until the bleeding has stopped for up to 24 hours (the exact time needed is unclear). Before removing it, ensure that at least 1 unit of cross-matched blood for possible transfusion is available, with the possibility of making more available if required. Theatre staff and an anaesthetist should be warned in case bleeding occurs when the catheter is removed. One approach is to remove 50 mL every 30 minutes until it is fully emptied. Observe the patient closely for 4 hours after removal of the catheter, looking at vaginal blood loss and vital signs. IV antibiotics should be given when the catheter is put in place, and should be continued for 48 hours.

Section 15:Major obstetric haemorrhage: postpartum haemorrhage

Figure 15.8 Condom catheter inflated with sterile IV fluid



An alternative new approach (in low resource settings involves inflating a condom with air rather than IV fluids (see Figure 15.9). It includes the following components:

- a firm type of urinary catheter (used for temporary insertion and drainage of urine) rather than an indwelling Foley catheter, which is easily constricted
- a latex male condom from a sterile and unbroken pack
- the inflator (with its tube) of an aneroid blood pressure machine
- a surgical suture (preferably black silk) for tying the condom to the catheter
- a piece of sterile thread for tying the end of the condom after inflation to stop the escape of air
- sterile gauze to pack the vagina and maintain the inflated condom in the uterine cavity.

Figure 15.9 Condom catheter inflated with air



Using a sterile procedure throughout, the catheter is inserted into the condom, with the end part of the condom touching the tip of the catheter. The lower part of the condom is tied to the catheter using suture thread and inserted into the uterine cavity. The condom is then held in place inside the uterine cavity using the non-dominant hand, the lower end of the catheter is connected to the inflator of the blood pressure machine (with the valve closed), and the condom is then inflated with air until the bleeding is either arrested or greatly reduced. Pneumatic pressure is rapidly achieved after a few inflations. The uterus gradually increases in size (this can be seen abdominally) as the condom is being inflated, and the woman should experience no more than slight discomfort. Excessive inflation of the condom must be avoided, and pain indicates that too much air is being forced into the

Section 15:Major obstetric haemorrhage: postpartum haemorrhage

condom. If this happens, loosening the valve of the inflator can easily reduce the volume of air.

Compared with inflating the condom with fluid (assuming that IV fluid is available, which is not always the case), this technique is much faster and easier, and good control is achieved by using the valve on the inflator.

7. Fluid resuscitation at the same time as the above manoeuvres

The aim of fluid resuscitation is to maintain perfusion of vital organs (the brain, heart and kidneys) during the manoeuvres described above.

1 Elevate the patient's legs (raise the foot of the bed).

2 Try to obtain two vascular access sites in order to give large volumes quickly, and in case one line is lost. Insert a wide-bore IV cannula (ideally two) (14 to 16G) and send blood for a full blood count, cross-matching (4–6 units) and clotting. If peripheral veins are difficult to access, the external jugular vein or long saphenous vein cut-down are good alternatives. If a skilled person is available, an internal jugular vein central line can be helpful, especially if the central venous pressure can be measured.

3 If venous access is not possible, consider inserting an intra-osseous line using the newly available drill system (see Section 9).

4 Give 500 mL of O-negative blood if it is immediately available. If not, standard practice is to give an initial rapid IV bolus of 1 litre of Ringer-lactate or Hartmann's solution (or of 0.9% saline if the former are not available) while waiting for blood for transfusion. It is essential that the IV bolus is given as rapidly as possible, with the aid of pressure bags or manual pressure. A blood pressure cuff that is wrapped around the fluid bag and inflated can be used to speed up infusions (see Figure 15.10). An alternative is to push the boluses in using a 20- to 50-mL syringe (with a three-way tap linked to the IV giving set).

5 As soon as it is available give 1 unit of blood (500 mL) as rapidly as possible, and repeat as required. Fresh blood is particularly useful for combat- ing the coagulopathy that occurs in major blood loss if specific coagulation components such as platelets are unavailable. Remember that blood loss is usually underestimated.

6 Further 500 to 1000-mL boluses of IV crystalloid or blood, if available, will usually be required in the first hour. Once more than 2 litres have been given IV, complications such as pulmonary oedema may sometimes occur, so be alert for circulatory overload. The concept of *targeted crystalloid fluid resuscitation* requires urgent research. If this approach is adopted the initial boluses of IV crystalloids required to treat shock would only be given to keep the vital organs (especially the brain, heart and kidneys) perfused before blood becomes available and, most important of all, before specific treatments to stop the bleeding have started to take effect. Giving too much IV crystalloid fluid may theoretically increase bleeding by disrupting early clot formation and damaging the coagulation system. There is no clear evidence to indicate the precise blood pressure or clinical signs that should be achieved in a woman in shock due to PPH. Adequate perfusion of vital organs may be indicated by a radial pulse that can be palpated and a fully alert conscious level.

Until bleeding has been stopped and blood is available for transfusion, our personal practice, especially in low resource settings, is therefore to start with IV boluses of 500 mL of crystalloid and reassess after each bolus.

7 Keep the patient warm but do not overheat them, as this will cause peripheral vasodilatation and reduce the blood supply to vital centres. Hypothermia will exacerbate poor peripheral perfusion, acidosis and coagulation abnormalities.

8 If there is evidence of a blood-clotting problem, give fresh-frozen plasma and/or other clotting factors (if available).

9 Further IV fluid administration should be guided by the response of the pulse rate, blood pressure and capillary refill time, and later by the hourly urine output. Aim for a pulse rate of ≤ 100 –110 beats/minute and a systolic blood pressure that is ≥ 90 –100 mmHg and stable.

Section 15: Major obstetric haemorrhage: postpartum haemorrhage

Figure 15.10 Pressure bag over bag containing Ringer- lactate or Hartmann's solution



Blood products

Fresh whole blood is the ideal choice if it is available. Full cross matching of blood may take up to an hour and is often unavailable in resource poor settings. In an emergency, group-specific blood should be used. The patient's blood group should have been established during pregnancy, as this facilitates the provision of blood when it is needed. O-Rhesus-negative blood can be transfused in acute emergencies.

All large-volume infusions of blood should be warmed. A good way of warming blood is to place each bag of blood or fluid under a relative's clothes next to their skin. Do not infuse cold fluid directly through a central venous line.

8. New potentially valuable treatments for PPH

Tranexamic acid

If there is continuing bleeding, especially if it has been caused by genital tract trauma, this inexpensive and safe drug can be helpful. Recent evidence has shown that tranexamic acid can reduce mortality from major haemorrhage in major trauma in adults. The drug should be started as soon as possible, and within the first 3 hours after the onset of major haemorrhage, in order to be effective.

The loading dose is 1 gram over 10 minutes followed by an IV infusion of a further 1gram over 8 hours.

The slow IV bolus dose is given by injecting 1 gram of tranexamic acid into a 100-mL bag of 0.9% saline and letting it run through over a period of about 10–20 minutes (the exact timing is not crucial).

The 8-hour infusion is given by injecting 1 gram of tranexamic acid into a 500-mL bag of 0.9% saline and giving it over a period of 8 hours (i.e. approximately 60 mL/hour). If there is a gap between the initial bolus and the subsequent infusion this probably does not matter too much, but ideally one should follow the other.

The non-pneumatic anti-shock garment (NASG)

This compression garment is made from neoprene, a stretchable material that recoils and applies pressure through the skin and consists of five segments that compress the legs (segments 1, 2 and 3), the pelvis (segment 4) and the abdomen (segment 5) (see Figures 15.11 and 15.12).



Figures 15.11-15.12 NASG

The abdominal segment includes a foam compression ball that presses on the area of the uterus. Velcro holds the segments in place.

Section 15: Major obstetric haemorrhage: postpartum haemorrhage

The NASG is reported to reduce shock by compressing blood vessels in the lower parts of the body, thereby diverting up to 30% of total blood volume to the heart, lungs, brain and possibly the kidneys. It is promising where there can be delays in transfer to facilities where comprehensive emergency obstetric care is available, and where blood transfusion and surgery can be undertaken. The NASG can give time for blood transfusion to become established and other treatments to be given, as well as reducing the amount of blood that subsequently needs to be transfused.

The NASG is applied in sequence from the lower legs up to the abdominal compression segment (segment 5). With experience one person can apply it in 2 minutes, although it takes from 5 to 10 minutes if the healthcare worker is alone and unused to applying it. Help from others present, such as porters or relatives, can be valuable.

In PPH due to uterine atony, it is particularly important that someone is massaging the uterus and giving the other treatments outlined above when the NASG is being applied. After the garment is in place the legs no longer need to be elevated and the uterus can still be externally massaged by placing one hand underneath the pelvic segment of the NASG. Vaginal examinations and repair of cervical or vaginal tears can be performed while the NASG is in place. The pelvic and abdominal segments can be opened for surgery such as emergency hysterectomy or B-Lynch sutures.

The NASG can be applied in addition to all the other measures for PPH described above when signs of shock first appear. The only contraindication to its use is known heart disease.

The NASG is removed segment by segment when bleeding has been reduced to safe levels and the patient's cardiovascular stability has been maintained for at least 2 hours (systolic blood pressure ≥ 90 – 100 mmHg, heart rate ≤ 100 – 110 beats/minute and haemoglobin concentration of ≥ 7 g/dL). Removal begins at the ankles with 15-minute gaps between each segment that is opened, and clinical measurements being made before each segment is removed. If the systolic blood pressure drops by ≥ 20 mmHg and/or the heart rate increases by ≥ 20 beats/minute, reapply that segment of the NASG and consider additional treatments such as further blood transfusion.

Between patients, the NASG can be laundered in the same way as for bloodstained sheets (see Textbook).

Stopping bleeding due to trauma to the perineum, cervix or vagina

If the bleeding continues despite all of the measures described above, examine the perineum, vagina and cervix with a sterile speculum. Postpartum bleeding with a contracted uterus is usually due to a cervical or vaginal tear. Trauma to the cervix or vagina is the second most frequent cause of PPH, and may coexist with an atonic uterus. Examine the mother carefully and repair any tears.

Bleeding from trauma can be substantial and may be fatal, especially if there is pre-existing severe anaemia. Suture packs, a torch, a Sims' speculum and sutures must always be immediately available on the PPH emergency trolley.

Initially stop the bleeding with sterile packing until a surgeon is able to repair the wounds.

It is essential to ensure that the uterus is contracted even when a traumatic cause is present.

Repairing a perineal tear

Get a good light, and start at the top of the tear. If difficult ask for help if available.

- 1 Anything except very minor tears should be repaired in the lithotomy or similar position as it provides a better view and is more comfortable for the surgeon/midwife.
- 2 Use a cutting needle on the skin and a round-bodied needle on other tissues.

Section 15:Major obstetric haemorrhage: postpartum haemorrhage

- 3 Put the first stitch in above the highest point of the tear (apex). This is usually within the vagina.
- 4 When you get to the junction between the vaginal mucosa and the skin, put a needle through the loop and tie a knot.
- 5 Continue by applying stitches into the muscle and fascia to close any dead space (gaping of the vaginal skin) and again tie a knot once done.
- 6 Next close the skin by placing the needle in through the skin on one side, and then in through the sub-cutaneous tissues and out through the skin on the other side. If using interrupted sutures, the stitches are usually inserted ~ ½ cm from the skin edges and approximately 1 cm apart from each other. Tie a knot after each stitch to oppose the skin.

Repairing a bleeding cervical tear

Place the patient in the lithotomy position and explain the procedure to the patient.

Get a good light and if at all possible an assistant.

Search all round the patient's cervix, if the cervix is not easily visible grasp it with a sponge holding forceps (or similar) and pull it into view. In order to visualise the entire cervix it is often necessary to follow the cervix round from anterior to posterior by pulling each segment down with the sponge holding forceps. Ideally two forceps are used and the next segment picked up with one set of forceps while traction is maintained with the other ('walking the cervix').

Once the cervical tear is identified start suturing it at its highest point (the apex).

If you cannot insert sutures, control the bleeding with a vaginal pack and transfer the patient.

Stopping bleeding due to retained placenta or retained products of conception

Examine the placenta and ensure that it is complete.

Retained placenta

A retained placenta is defined as occurring:

- 1 after active management of the third stage of labour, if the placenta is not delivered within 30 minutes of the birth
- 2 after expectant management of the third stage of labour, if the placenta is not delivered within 60 minutes of the birth.

Management of retained placenta

If there is a clinically significant PPH, the placenta must be removed urgently. Call for help (including an anaesthetist and an obstetrician), insert a venous cannula, take blood for haemoglobin and cross matching as for PPH, and ensure that the operating theatre is ready.

Massage the uterus, and if there is atony it should be managed as described for PPH above. However, although oxytocin should be used as necessary, ergometrine may cause tonic uterine contraction, which may delay expulsion.

Cause 1: The placenta is separated but trapped in the lower part of the uterus or cervix

- If the placenta is undelivered after 30 minutes of oxytocin, and the uterus is contracted and the placenta separated (usually indicated by the gushing of blood and rising of the uterus into the abdomen as a firm, more movable structure as with a normal placental separation and delivery), attempt controlled cord traction. During this procedure, and at all times, keep one hand on the abdomen to support the uterus and prevent its inversion.
- Avoid forceful cord traction and fundal pressure, as they may cause uterine inversion.
- This situation usually responds to firm and persistent traction on the cord with the other hand countering this on the uterus to prevent inversion. Ensure that the bladder is empty. Ask the mother to empty her bladder, otherwise catheterise the bladder if necessary.

Section 15:Major obstetric haemorrhage: postpartum haemorrhage

- If you can see the placenta, ask the mother to push it out; an upright position may help. Undertake a sterile vaginal examination and if you can feel the placenta in the vagina or cervix, remove it.

Cause 2: The placenta has failed to separate from the uterus

If controlled cord traction plus uterotonic drugs are unsuccessful, manual removal of the placenta is likely to be required (see below).

If the cord has broken from the placenta, it is still possible for the placenta to be pushed out by contractions and by the mother.

Cause 3: The placenta is morbidly attached to the uterus. Very adherent tissue may be **placenta accreta**, a situation that is more likely to occur after a previous Caesarean section. Efforts to extract a placenta that does not separate easily may result in heavy bleeding or uterine perforation, which usually requires hysterectomy.

Therefore, if there is any suspicion of a morbidly adherent placenta the patient should ideally be referred to a hospital with operating facilities and a surgical team (if available).

See pages xxx below for more details on management. Where there is significant haemorrhage, uterine and vaginal packing with gauze or balloon tamponade/condom catheter can halt the bleeding and eventually allow residual placenta to disintegrate and resorb/expel on its own. Hysterectomy will be needed if bleeding cannot be stopped by the measures described above.

If bleeding continues, assess clotting status using a bedside clotting test. Failure of a clot to form after 7 minutes, or formation of a soft clot that breaks down easily, suggests coagulopathy.

If there are signs of infection (fever with foul-smelling vaginal discharge), give antibiotics as for endometritis.

Manual removal of the placenta

This is a painful procedure associated with a high risk of infection unless it is undertaken using full sterile procedures.

Unless it is performed as an emergency for major PPH, we consider that manual removal of the placenta should be undertaken in an operating theatre with preceding morphine or ketamine in the presence of an anaesthetist.

Elbow-length sterile gloves should be used.

Provided that active PPH is not occurring, the mother should first be adequately resuscitated with IV fluids/blood and oxygen. The pulse rate, blood pressure, oxygen saturation and urine output should be closely monitored. Ideally, facilities for blood transfusion and, if necessary, emergency hysterectomy should be available.

After the placenta has been removed, massage the uterus to encourage tonic uterine contraction. An IV infusion of oxytocin 40 units in 500 mL or 1 litre of Ringer-lactate or Hartmann's solution should be administered over 4 hours to ensure continued uterine contraction.

A single dose of prophylactic antibiotics should be given just before all manual removals (2 grams of ampicillin IV or IM plus 80 mg of gentamicin IM/IV).

Figure 15.13 Introducing one hand into the vagina along the cord

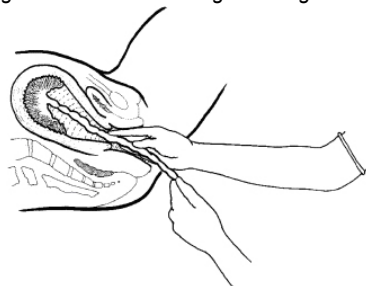

Figure 15.14 Supporting the fundus while detaching the placenta. Reach the placenta from the implantation site by keeping the fingers tightly together and using the edge of the hand to gradually make a space between the placenta and the uterine wall

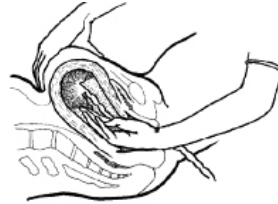
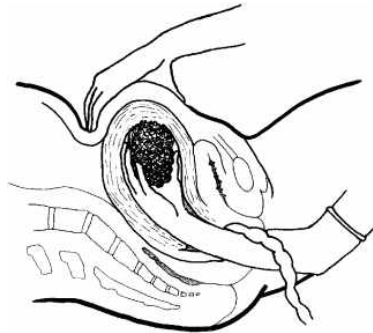

Figure 15.15 Withdrawing the hand plus the placenta from the uterus.



Treatment of PPH that continues despite all of the above interventions

Reassess the patient and determine whether bleeding is continuing and whether there is a clotting disorder. Assess the clotting status using a bedside clotting test (see page XX). Failure of a clot to form after 7 minutes, or formation of a soft clot that breaks down easily, suggests coagulopathy.

If bleeding continues, re-examine the patient and ensure that the oxytocin IV infusion is running correctly (40 units of oxytocin in 500 mL of Ringer-lactate or Hartmann's solution over 4 hours).

Exclude the following:

- inverted uterus
- retained products of conception
- damage to the genital tract: check for bleeding from the cervix, vaginal walls and perineum.

If the above measures fail to control PPH, do not wait too long.

The following operative interventions are available:

- B-Lynch sutures
- hysterectomy, which may be life-saving, and should be considered early in order to reduce the risk of life-threatening coagulopathy.

Check the haemoglobin levels or haematocrit after resuscitation and when the patient is stable. Consider administering oral iron if the patient is anaemic.

Treatment of secondary PPH

This is particularly dangerous in low-resource settings. Severe and life-threatening anaemia can develop rapidly, and frequently the woman is admitted in shock and urgently requiring blood transfusion. Severe life-threatening septic shock can also develop.

Section 15:Major obstetric haemorrhage: postpartum haemorrhage

1. Assess vital signs and temperature, and if the patient is shocked proceed as described above for massive PPH. Assess the uterine size, and perform a speculum and vaginal examination and note the degree of bleeding, whether the blood is offensive, whether the cervix is still open, and whether there is cervical and uterine tenderness.
2. Take a high vaginal swab for bacteriology (if available) before antibiotics are given. Insert an IV line and take blood for haemoglobin, blood cultures, cross matching and blood clotting (or clotting/ bleeding time if unavailable) (as DIC may occur).
3. Urgently start 7 days of treatment with IV antibiotics, as the bleeding is often secondary to infection. This is especially likely if there is foul-smelling lochia, a fever, or there has been prolonged rupture of membranes prior to delivery.
 - Give IV ampicillin 2 grams IV every 6 hours
 - **plus** gentamicin 80 mg IV or IM every 8 hours or 5 mg/ kg body weight IV/IM once every 24 hours
 - **plus** metronidazole 500 mg IV every 8 hours.Alternatively, give ceftriaxone 2 grams IV or IM once daily **plus** metronidazole 500 mg IV every 8 hours.
4. Provide blood transfusion (ideally fresh blood) if the haemoglobin level is < 5 g/dL, or if it is < 7.5 g/dL with symptoms suggesting early cardiac failure or shock or if there is brisk ongoing blood loss.
5. Examine for suspected retained placental fragments, but beware of the high risk of uterine perforation. Feel inside the uterus using elbow-length sterile gloves, and try to remove any retained products manually or using ovum forceps. Be very careful not to perforate the uterus. Placental tissue that sticks to the uterus may be placenta accreta, which may result in heavy bleeding (see below for management). If the cervical os has already started to close, this approach might not be possible. If a curette is used, it should be blunt, and great care should be taken as the uterus will be soft and easy to perforate. A vacuum aspirator (as used for treating miscarriage) or digital curettage may be safer options. Laparotomy is occasionally needed to deal with the continued bleeding from an infected or ruptured uterine incision or infected placental bed.

Figure 15.16 Evacuating the uterus.

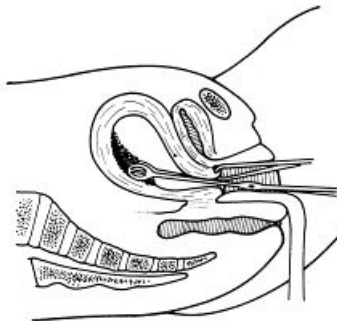

Management of placenta accreta

The placenta being morbidly adherent to deeper layers in the uterine muscle or even external to the uterus causes this serious complication. It is more common after a previous Caesarean section and in the presence of a placenta praevia. After Caesarean section an attempt should be made to assess the site of the placenta with ultrasound to determine whether it is likely to overlie the previous scar. If the patient undergoes a new Caesarean section, or has a retained placenta, the procedure should be carried out by the most experienced practitioner possible and preparations made for major haemorrhage, i.e. experienced anaesthetic assistance, good intravenous access, cross matched blood and availability of the non-pneumatic anti-shock garment.

Section 15:Major obstetric haemorrhage: postpartum haemorrhage

Option 1. Allow the placenta to be left in situ where it may separate and expel itself over time. This risks haemorrhage, infection and DIC and in these cases the mother must be made aware of these risks. She must be observed carefully for signs of infection, given prophylactic antibiotics (single dose of ampicillin 2 g IV/IM plus gentamicin 5 mg/ kg body weight IV/IM) and warned about what to expect when the placenta is eventually expelled. She must have rapid access to emergency care and be monitored as an inpatient.

Option 2. Attempt to remove the placenta. Haemorrhage should be anticipated and the procedure performed in theatre with adequate IV access, monitoring, cross-matched blood available and the most experienced anaesthetic and surgical personnel possible.

Option 3. Immediate hysterectomy in order to prevent later complications and the necessity for very close post-partum monitoring. The decision will need to be based on the patient's wishes, the resources available and the doctor's abilities. If there is no facility for emergency hysterectomy, the patient should be transferred to a facility where this is available.

Anaesthetic issues when managing PPH

Cardiovascular instability is a relative contraindication to spinal anaesthesia. Rapid sequence induction agents with minimal peripheral vasodilator action, such as ketamine, should be considered (see Textbook). Adrenaline and atropine should be readily available in case cardiovascular collapse occurs on induction. Ventilation with high concentrations of oxygen may be needed until the bleeding is controlled. Volatile agents have been associated with increased blood loss due to their relaxant effects on uterine muscle. Anaesthesia should be maintained with IV agents (ketamine or etomidate) if uterine atony is contributing to haemorrhage.

Disseminated intravascular coagulation (DIC)

Suspect and aggressively treat coagulopathy using warmed fresh blood, platelets, fresh-frozen plasma and cryoprecipitate as appropriate and available. DIC is more likely to occur if there has been a previous antepartum haemorrhage.

Monitoring

Once the bleeding has been controlled, frequent observations of respiratory rate, pulse rate, blood pressure, urinary output and oxygen saturation (if available) are vital both to detect problems and to monitor the response to treatment. At least 48 hours of close observations are required.

Section 15:Major obstetric haemorrhage: postpartum haemorrhage

Figure 15.17 Pathway of care for massive postpartum haemorrhage (PPH). NASG, non-pneumatic anti-shock garment

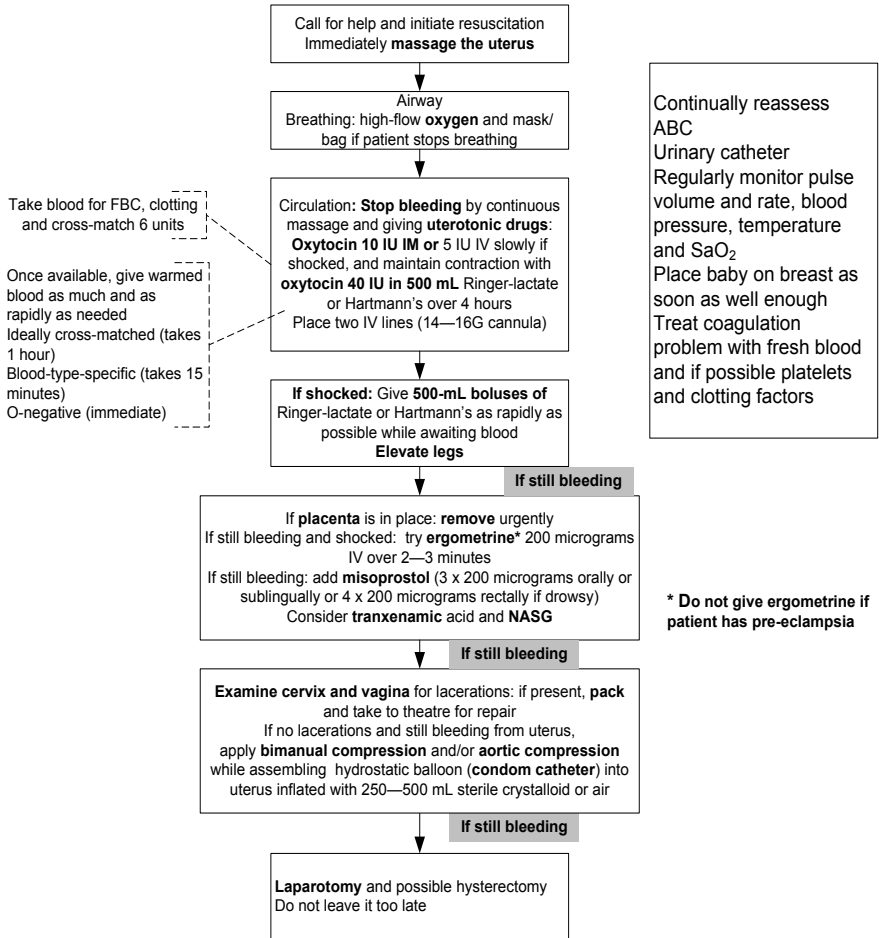

Section 16: Hypertension, pre-eclampsia and eclampsia

Hypertension in pregnancy occurs when the systolic blood pressure is ≥ 140 mmHg and/or the diastolic blood pressure is ≥ 90 mmHg. If the blood pressure is elevated, confirm this by making repeated measurements (see below).

Severe hypertension (systolic pressure ≥ 170 mmHg and/or diastolic blood pressure ≥ 110 mmHg) must be treated immediately, because a systolic or diastolic blood pressure at or above these levels is associated with a risk of cerebral haemorrhage, hypertensive encephalopathy and placental abruption.

Measuring blood pressure and looking for hypertension

When you measure the blood pressure of a woman, she should be rested and seated at a 45-degree angle with the machine on the bed beside her. Do not prop it up on her abdomen. Also do not lie her down, as this causes compression of the central veins. Open the cuff out flat, and make sure that you place the centre of the inner bladder on the artery. A falsely high reading will be obtained if the cuff's bladder does not encircle at least 80% of the circumference of the arm.

If the blood pressure is consistently higher in one arm, this arm should be used for all subsequent measurements.

Some automated blood pressure machines under-measure systolic blood pressure.

The systolic pressure is the onset of the first sound (Korotkov 1). The diastolic pressure is the complete disappearance of sounds (Korotkov 5). The normal systolic blood pressure in pregnancy is in the range 95–135 mmHg. The normal diastolic blood pressure is in the range 60–85 mmHg. Diastolic blood pressure measures peripheral resistance and does not vary with the woman's emotional state to the same degree that systolic pressure does. The blood pressure normally falls during the second trimester of pregnancy, reaching its lowest value by the end of the second trimester, and returning to pre-pregnancy levels at term.

If the systolic pressure is ≥ 140 mmHg and/or the diastolic blood pressure is ≥ 90 mmHg on two consecutive readings taken ≥ 4 hours apart, hypertension should be diagnosed.

In addition to a blood pressure of $\geq 140/90$ mmHg, any increase in systolic pressure of ≥ 30 mmHg or in diastolic pressure of ≥ 15 mmHg over recent previous measurements requires close monitoring, even if the pressures do not reach 140 mmHg systolic or 90 mmHg diastolic.

Pre-eclampsia

This is hypertension (blood pressure of $\geq 140/90$ mmHg) that develops after 20 weeks' gestation, always in association with proteinuria (≥ 0.3 grams in a 24-hour specimen). This level correlates with $\geq 1+$ on dipstick testing.

Pre-eclampsia is a multi-system disorder.

Other conditions cause proteinuria, and false-positive results are possible (e.g. due to contamination with normal vaginal discharge or amniotic fluid). Urinary infection may also produce proteinuria, but rarely $\geq 2+$ on dipstick testing. Blood in the urine due to catheter trauma, schistosomiasis or contamination with vaginal blood may also give false-positive results.

Random urine sampling, such as the dipstick test for protein, is a useful screening tool. A change from negative to positive during pregnancy is a warning sign. If dipsticks are not available, a sample of urine can be heated to boiling point in a clean test tube. Add a drop of 2% acetic acid to check for persistent precipitates that can be quantified as a percentage of protein in the sample. Only clean-catch midstream specimens should be used. Catheterisation for this purpose is not justified, due to the risk of urinary tract infection.

Section 16: Hypertension, pre-eclampsia and eclampsia

Oedema occurs with the same frequency in women with and without pre-eclampsia. However, if oedema develops suddenly and is widespread, always screen for pre-eclampsia. Test for oedema by pressing with your finger for 1 minute over the bony part of the mother's tibia. If there is a dent when you take your finger away, oedema is present. If the mother has been lying down, look for oedema over the sacrum. Oedema can also make a finger ring tight. Oedema of the face is more likely to represent a sign accompanying pre-eclampsia.

HELLP is a syndrome that consists of Haemolysis, Elevated Liver enzymes and Low Platelets. It may complicate pre-eclampsia, sometimes with only mild or borderline hypertension and marginally abnormal proteinuria.

Eclampsia is *fitting, convulsions or seizure* associated with the syndrome of pre-eclampsia. Seizures can occur without any previous signs or symptoms.

Gestational hypertension This is hypertension that develops only after 20 weeks' gestation but with no other features of pre-eclampsia, and which resolves within 3 months after birth. Patients who present early in pregnancy (after 20 weeks) and with severe hypertension are more likely to develop pre-eclampsia.

Chronic hypertension

1 Essential hypertension (also called primary hypertension) occurs before 20 weeks' gestation, without cause (see below).

2 Hypertension may also be secondary to other medical conditions such as chronic renal disease, endocrine disorders or diabetes mellitus.

It is important to control the hypertension in these cases, keeping the blood pressure below 150/100 mmHg, but not permitting the diastolic pressure to go below 80 mmHg.

Management of pre-eclampsia and gestational hypertension

Pre-eclampsia progresses during pregnancy, and the only definitive treatment is delivery. If the patient is at term (i.e. after 36 weeks) then, after stabilisation of the mother, the baby should be delivered as soon as possible.

For those at high risk of recurrence, low doses of aspirin reduce the risk of pre-eclampsia by about a sixth (17%), with a similar lowering of the risk of the baby dying (14%), and a small lowering of the risk of the baby being born too early (8%). Doses up to 75 mg appear to be safe and high-risk women are advised to start taking it from 12 weeks' gestation and to continue until delivery of the baby.

There is no evidence that bed rest improves the outcome for the mother or the fetus. Heavy physical labour is clearly inappropriate. However, women in low-income settings are commonly seen working in this way despite being in advanced pregnancy.

Mild cases can be cared for without hospital admission, but there need to be regular (at least weekly) checks on blood pressure and urine, and the family must be made aware of the warning signs of severe pre-eclampsia or eclampsia (see below).

If there is severe pre-eclampsia or eclampsia, if the blood pressure cannot be adequately controlled, or if there is pulmonary oedema, deteriorating renal or liver function, placental abruption or evidence of falling platelet counts or DIC, delivery is urgent but must always take place after stabilisation. In cases before 36 weeks' gestation, an injection of dexamethasone or betamethasone 12 mg IM, two doses 12 hours apart or 6 mg IM, four doses 12 hours apart, improves the likelihood of avoiding neonatal respiratory failure.

Stabilisation involves correction of severe hypertension, control of fluid intake and output, correction of blood-clotting disorders (in low-resource settings with fresh blood transfusion) and prevention or control of eclampsia (see below).

Antihypertensive drugs for pre-eclampsia

Section 16: Hypertension, pre-eclampsia and eclampsia

Mild pre-eclampsia does not require antihypertensive drugs.

If the systolic blood pressure is 150–160 mmHg and/ or the diastolic blood pressure is 95–105 mmHg, treatment with oral antihypertensive drugs should be started.

Systolic pressure of ≥ 170 mmHg and/or diastolic pressure of ≥ 110 mmHg must be urgently treated with antihypertensive drugs. However, **it is essential that the blood pressure is not lowered too rapidly**, as this can seriously affect the woman's cerebral circulation and the circulation to the placenta and fetus. Aim for a systolic blood pressure of 150 mmHg.

Oral antihypertensive drug treatment

Methyldopa

This drug takes 24 hours to work. The dose is 250 mg three times a day initially; increasing every 2 days up to 750 mg three times a day. Side effects include dry mouth, postural hypotension, sedation and depression. Methyldopa is contraindicated in patients with depression or liver disease. The simultaneous administration of oral iron and oral methyldopa can lead to a drug interaction that can result in clinically significant increases in blood pressure (> 15 mmHg increase in systolic pressure and > 10 mmHg increase in diastolic pressure).

Labetalol

This is a beta-blocker with mild alpha-blocking effects. The dose is 100–400 mg three times a day. Side effects include bradycardia, bronchospasm, weakness, scalp tingling (only for 24–48 hours), nausea and headache. Labetalol is contraindicated in patients with asthma.

Hydralazine

This is a vasodilator. The dose is initially 25 mg twice a day, increasing gradually to 50 mg three times a day. Side effects include uncontrolled hypotension, flushing, tachycardia, palpitations, headache and (uncommonly) a lupus syndrome.

Treatment of severe hypertension

It is essential that severe hypertension is controlled at any gestation, both before and after delivery.

Antihypertensive drugs should be given urgently to all patients with a systolic blood pressure of ≥ 170 mmHg and/ or a diastolic blood pressure of ≥ 110 mmHg.

Without urgent treatment there is a risk of cerebral haemorrhage, eclampsia and pulmonary oedema.

The aim should be a gradual and sustained reduction in blood pressure with one or more of the drugs described below.

Blood pressure should not be allowed to fall below 140/80 mmHg before delivery.

Hydralazine

Give 5 mg IV slowly over a period of 5 minutes (it acts within 5 minutes). Repeat the BP after every 15 minutes and treat with further doses of 5 mg until the diastolic blood pressure is 90–100 mmHg and the systolic BP is 140–160. Repeat the hydralazine hourly as needed, or give hydralazine 12.5 mg IM every 2 hours as needed.

Alternatively, give hydralazine IV infusion, 20 mg in 200 mL of 5% dextrose at 0.5 mL (10 drops) per minute (20 drops = 1 mL for a standard giving set), and stop the drip when the diastolic blood pressure is ≤ 90 mmHg. Hydralazine may cause an increase in the maternal heart rate.

Side effects include uncontrolled hypotension, flushing, tachycardia, palpitations, headache and (uncommonly) a lupus syndrome.

Labetalol

Section 16: Hypertension, pre-eclampsia and eclampsia

Intravenous labetalol is preferable to hydralazine if the maternal pulse rate exceeds 120 beats/minute.

The labetalol dosage is 10 mg IV. If the response is inadequate (i.e. if diastolic blood pressure remains above 110 mmHg) after 10 minutes, give a further dose of labetalol 20 mg IV. Increase the dose to 40 mg and then 80 mg if a satisfactory response is not obtained after 10 minutes of each dose.

Alternatively, use an IV infusion of 200 mg in 200 mL of Ringer-lactate solution at 40 mg/hour, increasing the dose at 30-minute intervals as required to a maximum of 160 mg/hour.

Side effects include bradycardia, bronchospasm, weakness, scalp tingling (only for 24–48 hours), nausea and headache. Labetalol is contraindicated in patients with asthma, as it may cause severe bronchospasm.

Nifedipine

The slow release/modified action version of the tablets should be used in this situation.

Nifedipine is a calcium antagonist that can be administered as an initial 10 mg oral dose (onset of action within 10–20 minutes), with a repeat dose of 10 mg if there is an inadequate response after 30 minutes. Subsequent oral doses are 20 mg twice a day. Side effects include severe headaches associated with flushing and tachycardia. Oedema, weakness and constipation may also occur. Nifedipine is contraindicated in patients with aortic stenosis. It may inhibit labour.

Give *prophylactic magnesium sulphate* if severe hypertension is accompanied by proteinuria and/or if protein testing is not available by symptoms that suggest that eclampsia may occur (see below).

Eclampsia or severe pre-eclampsia

Although pre-eclampsia and eclampsia are most common in the primigravida, they can occur in multiparous patients.

Symptoms and signs of impending eclampsia

- headache, visual disturbances, epigastric pain and vomiting
- rapidly developing generalised (especially facial) oedema
- pulmonary oedema
- right upper quadrant tenderness
- recently developed hypertension $\geq 170/110$ mmHg with proteinuria > 1 gram/24 hours or a rapid rise in blood pressure
- clonus and increased tendon reflexes
- HELLP syndrome.

Any headache or epigastric pain occurring in the second half of pregnancy should be investigated for pre-eclampsia (measure the blood pressure and test the urine for protein).

Differential diagnosis (see Table 16.1)

- A seizure/fit/convulsion:
 - in a patient with known epilepsy
 - in severe malaria (see Section 36)
 - in head injury (see Section 42)
 - in meningitis/encephalitis (see Section 33).
- Poisoning (Section 44)
- Amniotic fluid embolus (see Section 20).

Maintain a high index of suspicion of pre-eclampsia or eclampsia even in patients with malaria, migraine or epilepsy, as the conditions may coexist.

A small proportion of mothers with eclampsia have a normal blood pressure. Treat all convulsions as eclampsia until another diagnosis is confirmed.

Convulsions with signs of pre-eclampsia indicate eclampsia.

Section 16: Hypertension, pre-eclampsia and eclampsia

Convulsions due to eclampsia:

- can occur regardless of the severity of hypertension
- are difficult to predict, but rarely occur without increased tendon reflexes, headache or visual changes
- are tonic-clonic and resemble grand mal convulsions of epilepsy
- may recur frequently, as in status epilepticus, and may be fatal
- will not be observed if the woman is alone
- may be followed by coma that lasts for minutes or hours depending on the frequency of convulsions
- occur after childbirth in about 44% of cases, usually but not always within the first 24 hours after birth. The longer the gap between delivery and a fit, the more likely the diagnosis is to be a condition other than eclampsia (e.g. cerebral venous thrombosis).

The first eclamptic fit is usually self-limiting.

Control of blood pressure is essential in the management of severe pre-eclampsia or eclampsia where high blood pressure may cause a cerebrovascular accident (stroke). Magnesium sulphate is essential for preventing eclampsia and, if eclampsia occurs, for preventing further fits.

Table 16.1 Differential diagnosis of hypertension and convulsions in pregnancy

Symptoms	Signs	Results of investigations	Diagnosis	Treatment
None unless very severe	Blood pressure \geq 140/90 mmHg before 20 weeks' gestation	Urine for protein negative Renal function tests normal	Essential hypertension	Consider antihypertensive drugs
None unless very severe	Blood pressure \geq 140/90 mmHg before 20 weeks' gestation	Proteinuria \geq 2+	Hypertension secondary to other disease such as renal impairment, or autoimmune disease	Treat hypertension with drugs if severe, and treat the underlying condition
None unless very severe	Blood pressure \geq 140/90 mmHg after 20 weeks' gestation	No proteinuria	Pregnancy-induced hypertension	Treat hypertension with drugs if severe
None unless very severe	Blood pressure \geq 140/90 mmHg before 20 weeks' gestation	Proteinuria \geq 2+	Mild to moderate pre-eclampsia	Avoid work involving heavy labour

Section 16: Hypertension, pre-eclampsia and eclampsia

Symptoms	Signs	Results of investigations	Diagnosis	Treatment
Headaches increasing in frequency and unrelieved by paracetamol Visual disturbance Upper abdominal pain Shortness of breath Passing small amounts of urine Oedema	Blood pressure $\geq 140/90$ mmHg after 20 weeks' gestation Hyper-reflexia Passing less than 400mL of urine in 24 hours Pulmonary oedema Facial and rapidly developing oedema	Proteinuria $\geq 2+$	Severe pre-eclampsia Impending fit due to eclampsia	Urgent admission to hospital Magnesium sulphate
May be history of the symptoms in the row above Generalised convulsions Unconscious	Generalised fitting Coma Blood pressure $\geq 140/90$ mmHg after 20 weeks' gestation Facial and rapidly developing oedema	Proteinuria $\geq 2+$	Eclampsia	ABC Magnesium sulphate
Difficulty opening mouth and swallowing	Spasms of the face, neck and trunk Arched back Board-like abdomen		Tetanus	ABC, Penicillin, anti-tetanus immunoglobulin Muscle relaxants (magnesium and/or diazepam) Nasogastric feeding
Past history of convulsions	Convulsions Coma Normal blood pressure	EEG abnormal	Epilepsy	ABC, Blood glucose Anticonvulsant drugs
Chills/rigors Headache Muscle/joint pain	Fever Convulsions Coma Severe anaemia Jaundice	Blood smear for malarial parasites	Severe malaria	ABC, blood glucose Antimalarial drugs
Headache Stiff neck Photophobia Vomiting	Fever Stiff neck Reduced conscious level or coma Convulsions	Full blood count Blood culture Lumbar puncture (unless evidence of raised intracranial pressure)	Meningitis or encephalitis	ABC Antibacterial or antiviral drugs
Headache Blurred vision Photophobia History of migraine	Normal blood pressure	No proteinuria	Migraine	Paracetamol Bed rest in dark room

Section 16: Hypertension, pre-eclampsia and eclampsia

Symptoms	Signs	Results of investigations	Diagnosis	Treatment
Headache, vomiting, focal or generalized seizure, confusion, blurred vision, reduced consciousness	Focal neurological signs	Cerebral imaging if available	Stroke due to cerebral haemorrhage, infarction or cerebral vein thrombosis	ABC Expert neurological input

Primary assessment, resuscitation and emergency treatment of eclampsia

Call for help

- Never leave the patient alone.
- Prevent maternal injury during the convulsion.

Airway

• If the airway is not open, use an airway-opening manoeuvre and keep it open. Consider an airway adjunct such as an oropharyngeal airway or intubation. **Do not attempt to insert an oropharyngeal airway while the patient is convulsing.**

- The oropharynx may need gentle suctioning under direct vision, being careful to avoid inducing laryngospasm.
- The recovery position should be adopted to minimise the risk of aspiration of vomit.

Breathing

• If there is spontaneous breathing, give a high concentration of oxygen via a face mask plus reservoir. Give 100% oxygen (mask with reservoir and a flow rate of at least 5 litres/minute) regardless of the mother's oxygen saturation (this increases fetal oxygen delivery as well as improving maternal tissue oxygenation).

Figure 16.1 The recovery position



• If there is apnoea or hypoventilation, provide ventilation with bag-valve-mask-ventilation and 100% oxygen using reservoir.

Circulation

- Look for signs of life (breathing, movement, gagging/ coughing) or for a pulse at the carotid. If these are absent or you are not sure, initiate CPR (see Section 8).
- If the mother is over 20 weeks' gestation and uterus above umbilicus, put her in the left lateral tilt position and/or manually displace the uterus to reduce vena caval compression, or put her in the recovery position.
- Secure IV or intra-osseous access.
- Monitor the blood pressure.
- Attach a pulse oximeter.
- Insert a urinary catheter with strict fluid input/output chart.

Insert a 14G or 16G IV cannula and take 20 mL of blood for full blood count, blood group, cross-matching (4 units = 2 litres) and clotting. Do a 20-minute whole blood clotting time (WBCT20) test if laboratory analyses are not available (see Section 12).

Figure 16.2 Pathway of care for eclampsia when the mother is having convulsions

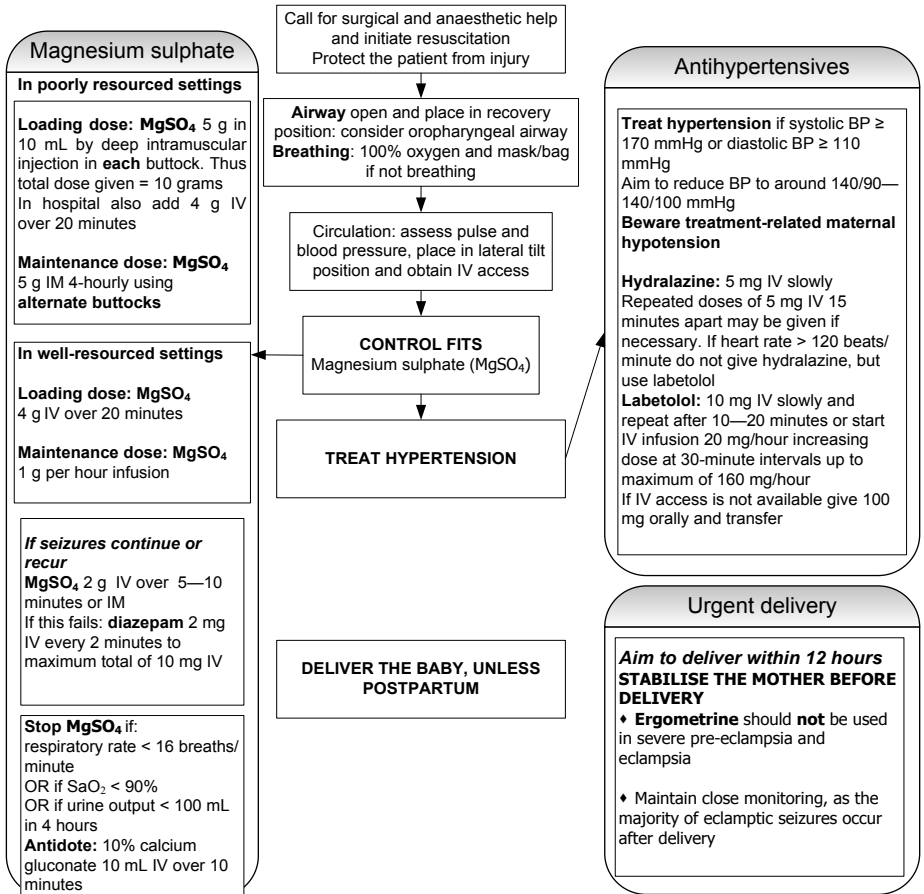

Emergency drug treatment of eclampsia

Stopping the convulsion and preventing further convulsions

The majority of seizures are self-limiting. Commence magnesium sulphate to prevent further fits.

Magnesium sulphate (MgSO₄) treatment

Magnesium sulphate is the anticonvulsant of choice.

If the mother is conscious, warn her that there will be a feeling of warmth passing through her body when magnesium sulphate is infused, and that this is not harmful. Failure to do so may result in the mother pulling out her IV cannula, and other potentially dangerous reactions.

Loading dose in well-resourced settings

Section 16: Hypertension, pre-eclampsia and eclampsia

Give 4 grams of MgSO₄ as 20 mL of a 20% solution of magnesium sulphate IV added to 80 mL of 5% dextrose solution given slowly over 20 minutes (total volume 100 mL). (To make 20 mL of a 20% solution, add 8 mL of 50% MgSO₄ solution to 12 mL of sterile water.)

If convulsions recur after completion of the loading regime, give 2 grams of MgSO₄ IV slowly over 10 minutes (10 mL of 20% solution is added to 90 mL of Ringer-lactate or Hartmann's solution).

Do not use the same IV line to inject other drugs if MgSO₄ is being given by IV infusion.

Loading dose in resource-limited settings

Give 5 grams of MgSO₄ (10 mL of 50% solution) by deep intramuscular injection in each buttock. Thus the total dose given is 10 grams. (Sometimes 0.5 mL of 2% or 1 mL of 1% lignocaine is given in the same syringe for each injection of 5 grams, to reduce the pain of the injections.) An aseptic technique is essential.

Maintenance dosage

- Well-resourced countries: Provided that there is close monitoring (ideally with a burette in giving set), give 1 gram of MgSO₄/hour IV for 24 hours (i.e. 25 mL/ hour of the loading dose solution of 4 grams in 100 mL described above).
- Resource-limited countries: give 5 grams of MgSO₄ IM 4-hourly (plus 1 mL of 1% lignocaine, or 0.5 mL of 2%, in the same syringe) using alternate buttocks.

Alternative regime in Asia

This regime is recommended in Asia where pregnant women are smaller than those in Africa and there are more resources.

Loading dose: Give 4 grams of MgSO₄ as 20 mL of a 20% solution added to 80 mL of 5% dextrose solution slowly IV over 20 minutes (total 100 mL). (To make 20 mL of a 20% solution, add 8 mL of 50% MgSO₄ solution to 12 mL of sterile water).

Then immediately give 3 grams (6 mL of 50% solution) by deep intramuscular injection in each buttock. (Sometimes 1 mL of 1% or 0.5 mL of 2% lignocaine is given in the same syringe, to reduce the pain of the injections.)

Maintenance dose

Give 2.5 grams of MgSO₄ IM every 4 hours using alternate buttocks.

Treatment if seizures continue or recur

Give 2 grams of MgSO₄ if body weight is less than 70 kg, or 4 grams if body weight is over 70 kg, as an extra loading dose IV over 5–10 minutes or IM in low-resource settings.

Alternative regime in very low resource settings

This regime is undertaken in some West African countries, and was recommended by the WHO in 2003.

Loading dose: 4 grams IV of MgSO₄ over 20 minutes: add 8 mL 50% to 92 mL Ringer-lactate or Hartmann's solution. This is followed by 10 grams 50% MgSO₄ solution IM (5 grams in each buttock: deep IM injections with lidocaine as above in the same syringe). Ensure that the needle is not in a vein.

Maintenance dose: This is 5 grams MgSO₄ 50% solution with lidocaine every 4 hours into alternate buttocks.

If eclampsia recurs, and only after 15 minutes, give 2 grams of MgSO₄ over 5 minutes IV: add 4 mL of 50% to 16 mL of Ringer-lactate or Hartmann's solution.

Continued treatment with magnesium sulphate

Section 16: Hypertension, pre-eclampsia and eclampsia

Continue MgSO₄ for 24 hours after delivery or the last convulsion, provided that:

- respiratory rate is > 12–16 breaths/minute
- urine output is > 30 mL/hour (WHO figure is > 100 mL over 4 hours)
- tendon reflexes are present.

Discontinue magnesium sulphate when:

- blood pressure is stable and consistently below 150/100 mmHg
- diuresis has started
- there are no neurological symptoms.

Monitor the fetus by regular heart rate assessments. A fluid balance chart must be kept (see below).

Remember to subtract the volume containing MgSO₄ infused from total maintenance infusion volume to avoid fluid overload.

When using magnesium sulphate, monitor hourly urine output, respiratory rate, SaO₂ and tendon reflexes every 15 minutes for the first 2 hours, and then every 30 minutes.

Symptoms and signs of magnesium toxicity

These include the following:

- double vision, confusion, slurred speech, nausea and weakness
- loss of tendon reflexes
- respiratory depression (< 12–15 breaths/minute) and/ or SaO₂ < 94%
- respiratory arrest
- cardiac arrest.

If magnesium toxicity is suspected, stop the infusion and if severe signs such as very slow respiration, respiratory or cardiac arrest, administer antidote of 10 mL 10% calcium gluconate IV slowly over at least 1–2 minutes.

Stop the infusion of magnesium sulphate if:

- patellar reflexes are absent
- there is respiratory depression (respiratory rate < 12–15 breaths/minute) or a fall in oxygen saturation to < 94% on a pulse oximeter. Give oxygen to keep oxygen saturation at > 94%
- urine output is less than 30 mL/hour over the last 4 hours.

If respiratory depression develops, give 100% oxygen by facemask with reservoir, and give calcium gluconate 1 gram (= 10 mL of 10% solution) IV slowly over 1–2 minutes. Too rapid administration can result in loss of consciousness, cardiac arrhythmias and cardiac arrest.

If respiratory arrest occurs:

- give chest inflations with bag-valve-mask ventilation with 100% oxygen
- inject calcium gluconate 1 gram (10 mL of 10%) IV slowly over 5 minutes.

The magnesium sulphate infusion may be recommenced at a reduced dose, if this is considered necessary, once normal respiration and reflexes have returned.

Note for anaesthetists: there is an increased sensitivity to muscle relaxants (particularly non-depolarising agents) in patients on magnesium.

In patients with known renal disease or myasthenia gravis, magnesium sulphate is contraindicated and, if available, phenytoin should be used. The loading dose is 15 mg/kg (maximum dose 2 grams) over 20 minutes by slow IV injection. Subsequently a dose of 100 mg orally twice a day can be given. IV injection if given too rapidly can cause severe hypotension, cardiac arrhythmias or respiratory arrest.

Other anticonvulsant drugs

If repeated fits occur despite magnesium sulphate, give either rectal paraldehyde (10–20 mL as an enema mixed with 10 parts of Ringer-lactate solution; do not give if it is a brownish colour or smells of acetic acid; note that it crosses the placenta) or rectal

Section 16: Hypertension, pre-eclampsia and eclampsia

diazepam (500 micrograms/kg or 10–20 mg; may cause neonatal hypothermia, hypotonia and respiratory depression).

Other causes of fitting should be considered if fits persist or recur despite magnesium sulphate. These include a cerebrovascular accident (stroke), malaria and meningitis. If magnesium sulphate is not available, use diazepam (see below).

Diazepam

A bag-valve-mask must be immediately available in case the patient stops breathing.

Loading dose: diazepam 2 mg increments IV every 2 minutes up to 10 mg. If convulsions recur, repeat the loading dose.

Maintenance dose: diazepam 40 mg in 500 mL of Ringer-lactate or Hartmann's solution, titrated to keep the mother sedated but able to be woken and without hypoventilation.

Maternal respiratory depression may occur when the dose exceeds 30 mg in 1 hour. Assist ventilation (e.g. bag-valve-mask, anaesthesia apparatus, intubation) if necessary, and do not give more than 100 mg in 24 hours.

Rectal administration: give diazepam rectally when IV access is not possible. The loading dose is 20 mg in a 10-mL syringe. Remove the needle, lubricate the barrel and insert the syringe into the rectum to half its length. Discharge the contents and leave the syringe in place, holding the buttocks together for 10 minutes to prevent expulsion of the drug. Alternatively, the drug may be instilled in the rectum through a catheter.

If convulsions are not controlled within 10 minutes, administer an additional 10 mg per hour or more, depending on the size of the woman and her clinical response.

Be prepared for neonatal resuscitation when diazepam has been administered, especially if it was used in large doses.

Summary of the management of severe pre-eclampsia and/or eclampsia

Stage 1: Prevention of fitting

If there are significantly increased tendon reflexes, often also with ankle clonus, before delivery or afterwards, and the patient shows other signs of impending eclampsia (e.g. confusion, jitteriness, severe headache), prophylactic 'anti-convulsant' therapy (magnesium sulphate where possible) should be commenced.

Other indications for magnesium sulphate treatment where eclampsia has not yet occurred include the following:

- persistent hypertension despite adequate antihypertensive drugs and good fluid management
- evidence of thrombocytopenia or liver dysfunction (if these can be measured).

The same regimen of magnesium sulphate (or diazepam if magnesium sulphate is not available) is used for prophylaxis as described above for the treatment of eclampsia. A loading dose alone may be sufficient.

Stage 2: Reduction of blood pressure and expansion of intravascular volume

Hypertension should be treated if the blood pressure is $\geq 170/110$ mmHg as described above. Careful fetal monitoring during the commencement of treatment is vital, as a rapid fall in maternal blood pressure may cause fetal distress, especially in a growth-restricted or compromised fetus.

If the gestation is less than 36 weeks, dexamethasone or betamethasone 12 mg IM in two doses 24 hours apart should be given to improve fetal lung maturity and decrease the risk of neonatal respiratory failure, if time allows.

Antihypertensive drugs; see above.

Volume expansion during antihypertensive treatment for severe hypertension

Section 16: Hypertension, pre-eclampsia and eclampsia

Antihypertensive agents such as nifedipine and hydralazine act as vasodilators. In pre-eclampsia where intravascular volume is already reduced, a small volume load should be given immediately prior to IV antihypertensive treatment (300 mL of Ringer-lactate or Hartmann's solution IV over 20 minutes). Colloid or starch, such as Haemaccel (500 mL), which remains for longer in the intravascular compartment, may be helpful. Clinical examination for signs of cardiac failure (see pages xx) should be sought before and after such treatment.

Stage 3: Anticipate and/or manage complications

Airway and breathing

- Keep the airway clear.
- The respiratory rate should be recorded regularly (ideally it should be 15–40 breaths/minute).
- Beware of over-sedation, aspiration, pulmonary oedema and laryngeal oedema (which presents with stridor).
- If the respiratory rate is less than 12–15 breaths/minute, particularly if the mother is receiving magnesium sulphate, action should be taken and other signs of toxicity sought (see above).

If magnesium sulphate is being given, stop this and give calcium gluconate (see above).

- Oxygen can be given using nasal cannulae (ideally with SaO₂ monitoring) if SaO₂ is less than 94%. Keep SaO₂ >94%.
- Arrange for a chest X-ray if aspiration is suspected.
- An increased respiratory rate is an early sign of pulmonary oedema.

Circulation

Monitor fluid balance and prevent fluid overload (urinary catheterisation is important).

Usually there is net fluid overload in pre-eclampsia, but the fluid has leaked out of the intravascular compartment due to low oncotic pressure (partly due to hypoalbuminaemia) and increased capillary permeability.

Complications of excessive fluid in the wrong compartment include cerebral oedema, pulmonary oedema and laryngeal oedema (stridor).

Renal failure may develop secondary to the hypertension or to intravascular hypovolaemia (or as a primary injury in severe pre-eclampsia).

Keep IV fluids at a rate of less than 100 mL/hour or less than 1 mL/kg per hour (WHO suggests a rate of less than 1 litre in 6–8 hours). Fluid restriction should be maintained until there is post-partum diuresis, which is easy to recognise as there is usually oliguria in severe pre-eclampsia. If there is APH or PPH, fluid restriction will probably not be appropriate.

- Insert an indwelling urinary catheter, and keep a strict intake–output chart with hourly running totals. The total maintenance fluid intake should not exceed 1.5–2 litres over 24 hours. If the average urine output is less than 30 mL/hour over a period of 4 hours this is usually due to the decreased intravascular volume, and will respond to a bolus of 200 mL of IV Ringer-lactate or Hartmann's solution, which can be repeated if necessary.
- In the presence of over-hydration, particularly with heart failure or renal impairment, furosemide 20–40 mg IV should be given. Mannitol is not advisable because of the fluid load that results from its administration, and because of its rebound effects.
- Beware of cardiac arrhythmias. Ideally monitor potassium levels regularly and ECG continuously.
- Magnesium sulphate is renally excreted, so careful observation for magnesium toxicity is required if there is oliguria.
- Fluid infusion equal to the same quantity as the urinary output in the preceding hour plus 30 mL is a useful guide to IV fluid administration.

Section 16: Hypertension, pre-eclampsia and eclampsia

- Central venous pressure (CVP) monitoring may be useful to guide management, especially if urine output is low. (Keep the CVP at up to + 6 cmH₂O in a spontaneously breathing patient.)

Additional organ involvement

Neurological complications

These include cerebrovascular accidents and cerebral oedema.

Undertake regular (2-hourly) neurological examination (including pupillary and tendon reflexes) and record the AVPU and/or Glasgow Coma Scale (GCS) scores. All patients should be able to open their eyes to stimulus, obey commands and respond to questions about their name and age. If not, they are over-sedated or may be developing cerebral complications.

A GCS score of ≤ 8 indicates coma and an airway that is not protected by pharyngeal and/or laryngeal reflexes.

Cerebral oedema is usually localised to the occipital and parietal cortical areas, and is a result of cerebral vasospasm. Magnesium sulphate can help to prevent this. Mannitol is not indicated. Recurrent convulsions despite magnesium sulphate with or without other anticonvulsants may require intubation and controlled ventilation (if available).

Haematological complications

These include disseminated intravascular coagulation (DIC).

- Group and save and cross-match fresh blood.
- Check the full blood count, including a platelet count if possible.
- Do a whole blood clotting test as well as APTT (if available) (see xx). Failure of a clot to form after 7 minutes, or formation of a soft clot that breaks down easily, suggests coagulopathy.
- If the platelet count is $> 100,000 \times 10^9/L$, a major coagulation problem is unlikely. Spontaneous haemorrhage may occur with counts below $10,000 \times 10^9/L$.
- In frank DIC, give whole fresh blood if there is bleeding.

Hepatic complications

These include jaundice, bleeding tendency, hepatic failure, hepatic sub-capsular oedema or hepatic rupture (the last two cause right upper quadrant or epigastric pain). Delivery of the baby is urgent.

Fetal problems

These include intrauterine growth retardation, fetal distress in labour, preterm delivery as a result of obstetric intervention, fetal death due to placental abruption or fetal asphyxia in labour.

General nursing care

- Airway and breathing management should be undertaken as appropriate. This includes ensuring that SaO₂ remains normal at $>94\%$.
- Maintain the patient in the lateral tilt or recovery position at all times before delivery.
- Indwelling aseptically placed urinary catheter and hourly urine output measurement.
- Care of eyes and oral hygiene.

The HELLP syndrome (Haemolysis, Elevated Liver enzymes, Low Platelet counts) syndrome is a dangerous form of severe pre-eclampsia.

- If the platelet count is $< 50,000 \times 10^9/L$ there is a high risk of bleeding, and if bleeding occurs in the absence of platelet transfusions, fresh blood may be helpful.
- Liver dysfunction may cause upper abdominal pain, and lowering of the blood pressure may be helpful.

Delivery is urgent.

Stage 4: Delivery of the baby

The need for in-utero transfer should be considered, particularly if there are maternal complications that are likely to require a Caesarean section or high-dependency care. The need for delivery is dependent on the maternal and fetal conditions. Either Caesarean section or induction of labour may be appropriate, depending on the clinical findings. Although delivery will resolve the disease, it is inappropriate to deliver an unstable mother, even if there is fetal distress. Once eclamptic seizures have been controlled, severe hypertension has been treated and any hypoxaemia corrected, delivery can be expedited.

In severe pre-eclampsia, aim to deliver within 24 hours of the onset of symptoms. In eclampsia, aim to deliver within 12 hours of the onset of convulsions.

It is important to stabilise the mother's condition first. Then decide about the mode of delivery.

In selected patients, labour may be induced if the following conditions apply:

- the cervix is favourable
- the maternal condition is stable (i.e. eclampsia and blood pressure are controlled), there is no fetal distress and there is a cephalic presentation.

Assessment of the cervix

- If the cervix is favourable (i.e. soft, thin and partly dilated), rupture the membranes with an amniotic hook or a Kocher's forceps, and induce labour using an oxytocin infusion or oral misoprostol. (see below)
- If vaginal delivery is not anticipated within 12 hours (for eclampsia) or within 24 hours (for severe pre- eclampsia), deliver by Caesarean section.
- If there are fetal heart rate abnormalities, consider Caesarean section if this is safe for the mother.
- If the cervix is unfavourable (i.e. firm, thick and closed) and the fetus is alive, deliver by Caesarean section if the mother is adequately resuscitated.
- If there are no facilities for Caesarean section or if the fetus is dead or too premature for survival, deliver vaginally.

Aiming for vaginal delivery

If the cervix is unfavourable (i.e. firm, thick and closed) and the fetus is alive, Caesarean section should be performed. If the fetus is dead, consideration should be given to induction of labour using misoprostol (unless there has been a previous Caesarean section, in which case misoprostol is contraindicated).

There are many possible misoprostol regimens for induction of labour (vaginal misoprostol tablet, oral misoprostol solution or oral misoprostol tablet). Each has been widely used. The latest evidence is that oral misoprostol solution is the most appropriate treatment (Cochrane reviews).

Oral misoprostol solution: A single misoprostol tablet is dissolved in drinking water (a 200-microgram tablet in 200 mL of water or a 100-microgram tablet in 100 mL of water), and 20–25 mL of misoprostol solution (20–25 micrograms) are then given every 2 hours. The solution is stable for up to 24 hours at room temperature, but should then be discarded.

Oral misoprostol tablets: 100-microgram misoprostol tablets are cut to 25 micrograms size and administered orally every 2 hours up to a maximum of six doses. However, this may not be very accurate, so there is a danger of giving an incorrect dosage. The solution described above is much safer.

Caesarean section

Section 16: Hypertension, pre-eclampsia and eclampsia

If Caesarean section is performed, ensure that coagulopathy has been treated. Ensure that fresh blood for transfusion is available.

Spinal anaesthesia is usually safer than general anaesthesia for Caesarean section, unless there is a contraindication (e.g. maternal refusal, coagulopathy, thrombocytopenia, decreased conscious level, ongoing seizures). There does not appear to be an exaggerated decrease in blood pressure after spinal anaesthesia, and vasopressors (e.g. ephedrine) should be used cautiously in order to avoid a hypertensive response. An IV bolus of 500 mL of Ringer- lactate or Hartmann's solution may occasionally be required if the blood pressure does fall.

The use of general anaesthesia in severe pre-eclampsia or eclampsia is hazardous. There may be laryngeal oedema, which makes airway management difficult, and increases in blood pressure during intubation and extubation, with an increased risk of intracranial haemorrhage. Drugs to weaken the vasopressor response to intubation should be used.

Local anaesthesia or ketamine in women with pre- eclampsia or eclampsia are contraindicated unless facilities and/or expertise dictate that these are the safest options in a given situation.

Stage 5: Management after delivery

- If the patient is post-eclampsia or at high risk of convulsions, continue to administer parenteral anticonvulsants (i.e. magnesium sulphate, or diazepam if magnesium sulphate is not available) for 24 hours after the birth. Continue for as long as the patient has increased tendon reflexes.
- Do not give ergometrine to women with pre- eclampsia, eclampsia or high blood pressure, because it increases the risk of convulsions and cerebrovascular accidents.
- Monitor the mother closely.
- Give antihypertensive agents urgently if the diastolic blood pressure is > 105 mmHg or the systolic blood pressure is > 160 mmHg.
- Continue oxytocin infusion to keep the uterus contracted.
- Syntometrine (which contains ergometrine, and can cause or worsen hypertension) is contraindicated. Give oxytocin alone or with misoprostol, and avoid the possible hypertensive effects of ergometrine. If postpartum haemorrhage occurs, this should be managed as described in Section 15)
- Keep the mother in the delivery unit or close observation area for at least 24 hours after the last fit.
- Review the need for further anticonvulsants and anti- hypertensive drugs.
- Regular monitoring is essential.
- It is not uncommon for the blood pressure to drop transiently following delivery only to rise again after 24 to 48 hours. Patients with severe pre-eclampsia and eclampsia should be monitored as in-patients for 72 hours after delivery so that dangerous post-partum rises in BP can be detected and treated.
- Plans for care should be communicated to the patient and her attendants. The attendants should be educated about the use of the left lateral tilt position prior to delivery, the use of the recovery position after convulsions, the risk of aspiration of food, and care of the IV site.
- Before the mother goes home, the family and attendants should be warned about the risk of postnatal depression, especially if the outcome has been poor. The woman or girl should be followed up closely in the community.
- In women with severe pre-eclampsia/eclampsia a plan should be made to monitor the BP in the post-partum period, even in women who are not discharged on antihypertensive medication. This is because the BP is commonly labile during this period. One or ideally two checks (or more if the BP is poorly controlled) should be advised over the first 2 weeks following delivery. This may be done at a clinic local to the patient's residence, but may require that the patient stay in or near the hospital if no facilities exist.

Section 16: Hypertension, pre-eclampsia and eclampsia

- Women and their families should also be warned about the symptoms of severe pre-eclampsia and advised that although delivery does usually resolve the disease, it can still worsen suddenly in the first 2 weeks following delivery (rarely up to 6 weeks).
- Antenatal care provided by the hospital during a future pregnancy is important. There is an increased risk of pre-eclampsia and hypertension.
- All patients are at risk of deep vein thrombosis (DVT), so close observation and appropriate treatment if DVT is identified are important (see Section 19). Anti-embolism stockings and low-molecular-weight heparin (or unfractionated heparin if the former is not available) prophylaxis should be considered early on.

Hypertension may take from many days to up to 3 months to resolve. Resolution will occur if the diagnosis is pre-eclampsia, unless there is an underlying medical cause.

Section 17: Prolonged and obstructed labour, uterine rupture and shoulder dystocia

Recognition of prolonged or obstructed labour and early referral

The 3 P's: Power (too little), Passenger (too big) and Passage (too small).

Main causes of slow progress in labour

These include the following:

- 1 poor-quality uterine contractions
- 2 malpresentations and malpositions
- 3 disproportion between the size of the baby and the size of the pelvis (CPD); it is important to exclude causes (1) and (2) before diagnosing this.

Diagnostic issues in obstructed labour

The mother

- The patient may be dehydrated, tachycardic, ketotic (urine positive for ketone bodies, breath smells of ketones), febrile and exhausted, and there may be infected vaginal secretions.
- The bladder may be distended with retained urine, or it may be oedematous.
- Abdominal examination may reveal haemoperitoneum from a ruptured uterus. Blood may not appear vaginally, due to the impacted fetal head, which should be dislodged upwards to allow full assessment. If a ruptured uterus is suspected, a laparotomy should be performed (see below).
- Abdominal examination may reveal distended bowel from sepsis and ileus.

The fetus

- The lie and relationship of the fetus to the pelvis must be assessed.
- Despite visible caput at the introitus, 60% of the fetal head may still be palpable abdominally.

TABLE 17.1 Diagnosis of unsatisfactory progress of labour

Clinical signs	Diagnosis
Cervix not dilated No palpable contractions/infrequent contractions	False labour
Cervix not dilated beyond 4cm after 8 hours of regular contractions	Prolonged latent phase
Cervical dilatation to the right of the alert line on the partogram	Prolonged active phase
Secondary arrest of cervical dilatation and descent of the presenting part in the presence of good contractions	Cephalo-pelvic disproportion
Secondary arrest of cervical dilatation and descent of the presenting part with large caput, third-degree moulding, cervix poorly applied to the presenting part, oedematous cervix, ballooning of the lower uterine segment, formation of a retraction band, and maternal and fetal distress	Obstruction
Less than 3–4 contractions in 10 minutes, each lasting from less than 40 seconds to 1 minute, with 1 minute of relaxation between contractions	Inadequate uterine activity
Presentation other than vertex with occipito-anterior position	Mal-presentation Mal-position
Cervix fully dilated and the woman has the urge to push, but there is no descent	Prolonged expulsive (second stage) phase

Section 17: Prolonged and obstructed labour

Figure 17.1 shows the partogram for Mrs H admitted in active labour at 10 am

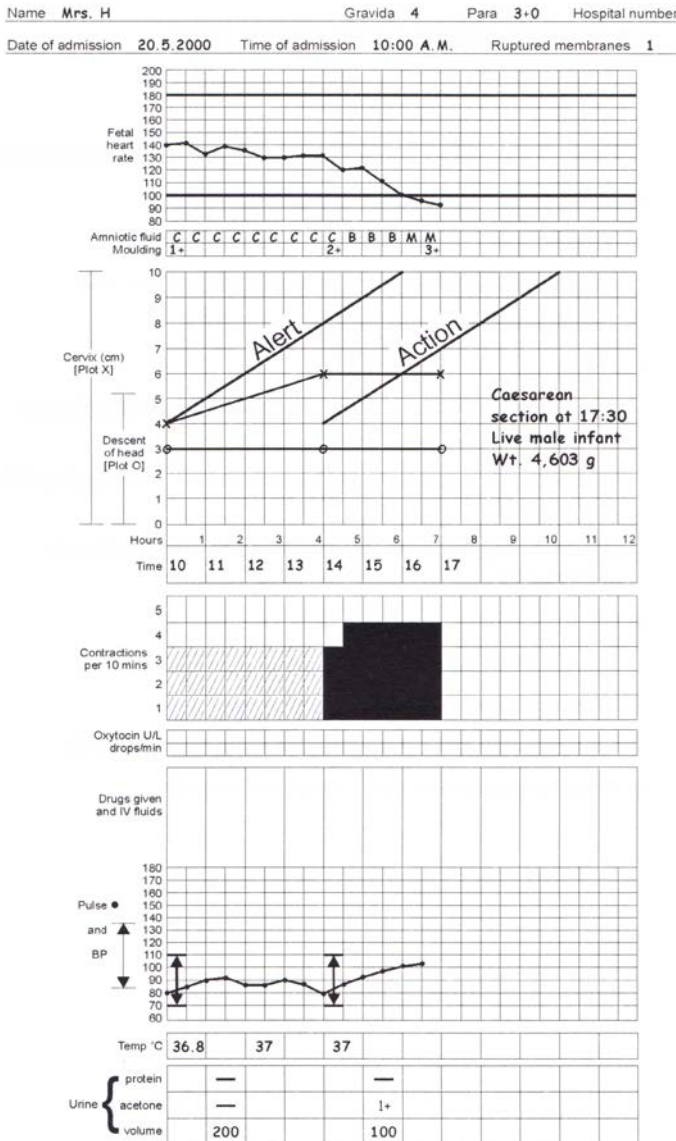

On admission

The fetal head is 3/5 palpable.

- The cervix is dilated to 4 cm.
- Three contractions occur in 10 minutes, each lasting for 20–40 seconds.
- Clear amniotic fluid is draining.
- There is fetal head moulding.

At 2 pm:

The fetal head is still 3/5 palpable.

- The cervix is dilated to 6 cm and to the right of the alert line.

There is a slight improvement in contractions (three in 10 minutes, each lasting for 40 seconds).

- There is second-degree moulding.

At 5 pm:

The fetal head is still 3/5 palpable.

- The cervix is still dilated to 6 cm.

There is third-degree moulding.

- The fetal heart rate 92 beats/minute.

Caesarean section was performed at 5.30 pm.

Note:

The partogram for Mrs H is characteristic of obstructed labour. There is arrest of cervical dilatation in

the active phase of labour, with no descent of the fetal head.

The presence of meconium and a falling fetal heart rate suggest fetal distress. All of these features, plus moulding of the fetal skull bones, point to cephalo-pelvic disproportion.

Oxytocin was rightly withheld, as Mrs H was multiparous, and this drug would therefore have increased the risk of uterine rupture in this patient.

Section 17: Prolonged and obstructed labour

Figure 17.2 Partogram in Mrs M showing prolonged active phase of labour

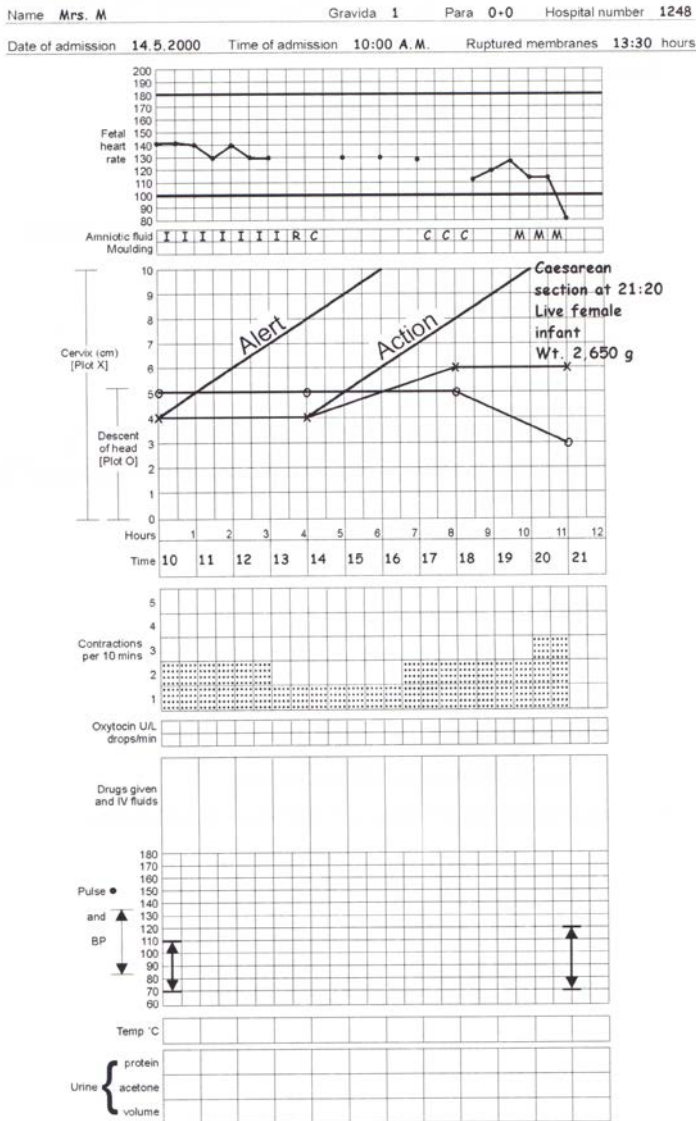

The cervix in the primigravida whose partogram is shown in Figure 16.2 was 4 cm dilated on admission. Her contractions were ineffective at two in 10 minutes, decreasing to one contraction in 10 minutes. Her membranes ruptured 3.5 hours later, but her cervix dilated only a further 2 cm in 4 hours, with no further dilatation in the subsequent 3 hours. Fetal distress developed, with meconium and a falling fetal heart rate. Caesarean section was performed. It would have been advisable to start an oxytocin infusion at 13.30 hours, or at least by 15.30 hours.

Section 17: Prolonged and obstructed labour

Figure 17.3 Partogram in Mrs J showing inadequate uterine contractions corrected with oxytocin.

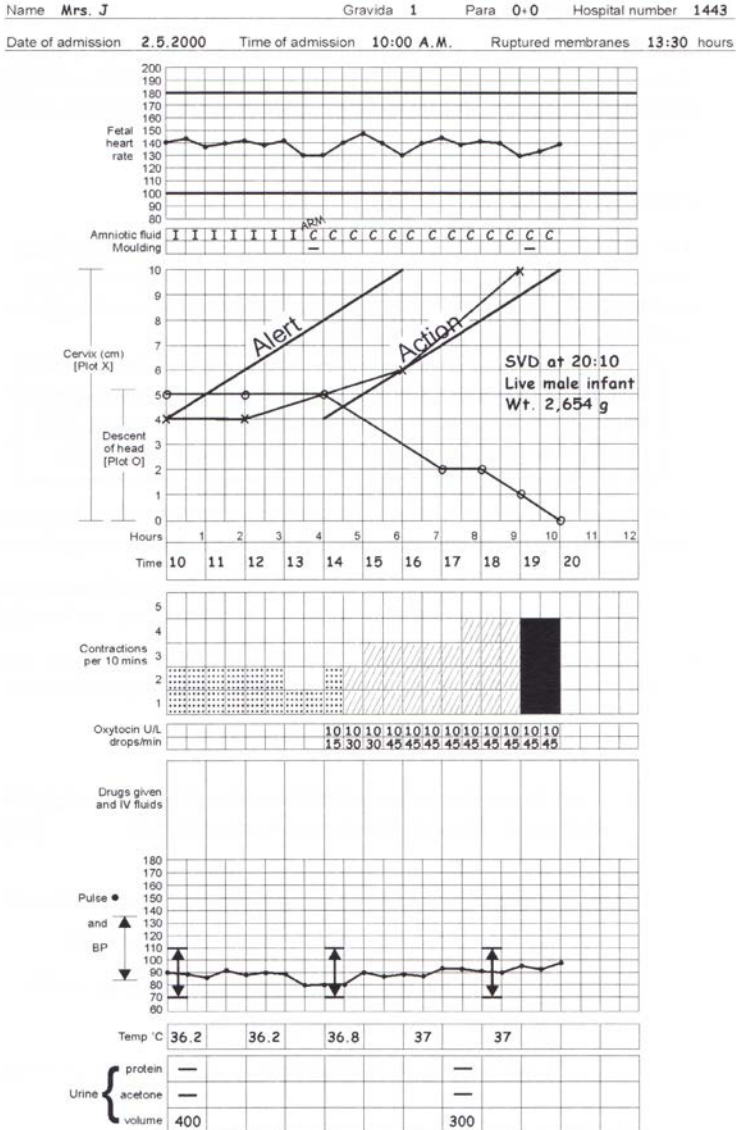

The primigravida whose partogram is shown in Figure 16.3 started an oxytocin infusion at the time of membrane rupture, which increased the efficacy of contractions. She progressed to a spontaneous vaginal delivery. The fetal heart rate was satisfactory throughout.

Figure 17.4 Pathway of care in obstructed labour

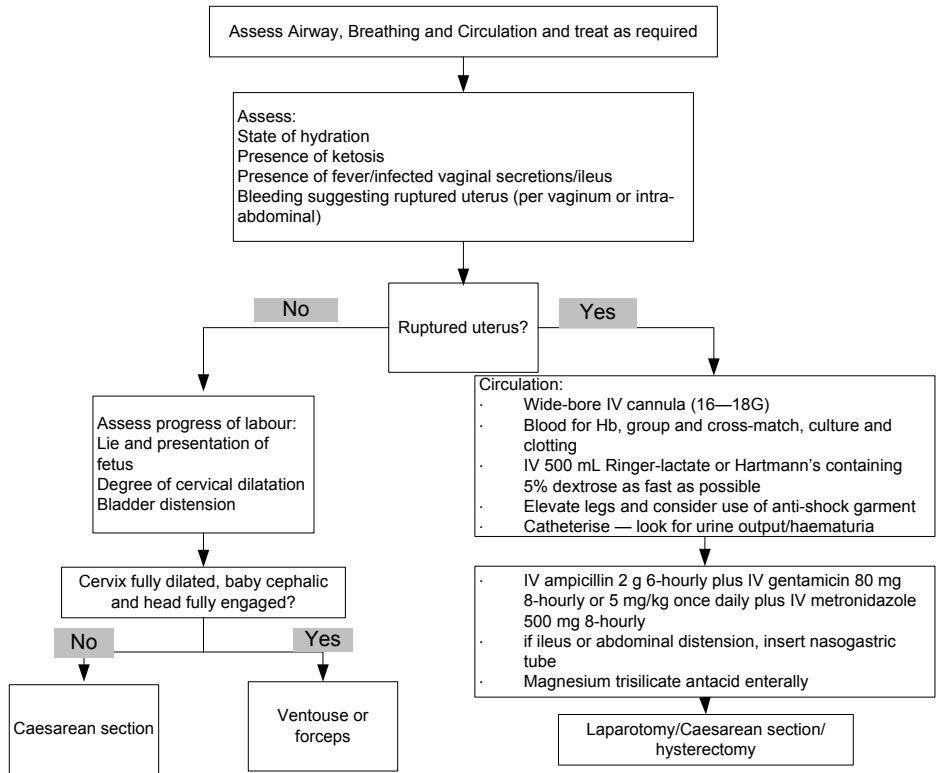

Emergency treatment for obstructed labour

Assess ABC and resuscitate if required.

- Place a wide-bore IV cannula (14- to 16G).
- Place the mother in the left lateral tilt or recovery position.
- Send blood for haemoglobin, grouping and cross-matching, and electrolytes if possible.
- Give 1 litre IV of Ringer-lactate or Hartmann's solution containing 5% or 10% glucose over 1 hour as an infusion, or as rapidly as possible if the patient is shocked. Then reassess.
- Catheterise the patient to decompress the bladder, measure urine output and look for haematuria.
 - The presence of haematuria may suggest uterine rupture.
 - If there is concern about the viability of the vaginal and bladder wall, the catheter may be kept in situ for up to 6 weeks to prevent or minimise the formation of a vesico-vaginal fistula.
- Give IV ampicillin (2 grams 6-hourly) **plus** gentamicin (80 mg IV/IM 8-hourly or 5 mg/kg body weight IV/IM once every 24 hours) **plus** metronidazole (500 mg 8-hourly). Cefuroxime (1.5 grams 8-hourly, if available) can be given instead of ampicillin plus gentamicin.
- Measure the pulse rate, capillary refill time (CRT), blood pressure, temperature and urine output frequently.
- If uterine rupture has been excluded, shock may be due to hypovolaemia, sepsis or both.

Section 17: Ruptured uterus

If there has been recent food intake, or abdominal distension is present, the stomach should be emptied using a nasogastric tube, and then 10 mL of magnesium trisilicate oral suspension should be given to reduce the acidity of the gastric contents.

Overcoming slow progress in labour

- If the cervix is fully dilated and there is cephalic presentation and no signs of obstruction, instrumental delivery (ventouse or forceps) can avoid the need for Caesarean section. However, if the cervix is fully dilated and there is obstruction, instrumental delivery can make Caesarean section very difficult by causing further impaction of the fetal head.
 - If the cervix is not fully dilated, in the primigravida with cephalic presentation, give an oxytocin infusion.
 - If the cervix is not fully dilated, with abnormal presentation, perform a Caesarean section.
 - If there is a ruptured uterus, a laparotomy and Caesarean hysterectomy must be performed.
- Urgent referral is required if the above measures are not possible. Stabilise the mother's ABC before transfer if necessary.

Rupture of the uterus

Symptoms and signs

Uterine rupture usually presents with shock, but vaginal bleeding can be concealed. The baby is usually dead. Around 50% of ruptures occur at or near full dilatation.

- There is a change from severe intermittent pain to a constant dull ache.
- Vaginal bleeding may or may not be present.
- There is maternal shock due to blood loss with or without vagal stimulation, as well as dehydration, exhaustion, and ketoacidosis in cases of prolonged obstructed labour.
- Abdominal distension occurs that is tender to palpation, the fetal parts may be very easily palpated, and there is absence of a fetal heart rate.
- On vaginal examination, the presenting part may be high or impacted.
- Uterine rupture may be preceded by the appearance of Bandl's ring

Primary assessment and resuscitation

Call for help, especially for a surgeon and an anaesthetist, as urgent laparotomy will be required.

Airway

- If the airway is not open, use an airway-opening manoeuvre and keep it open. Consider an airway adjunct such as an oropharyngeal airway or intubation.
- The oropharynx may need gentle suctioning under direct vision, but be careful to avoid inducing laryngospasm.
- The recovery position should be adopted to minimise the risk of aspiration of vomit

Breathing

- If there is spontaneous breathing, give a high concentration of oxygen via a face mask with reservoir. Give 100% oxygen (mask with reservoir and flow rate of at least 6 litres/minute) regardless of the mother's oxygen saturation. This increases fetal oxygen delivery as well as improving maternal tissue oxygenation.
- If the patient is apnoeic or hypoventilating, provide chest inflations with bag-valve-mask-reservoir ventilation and high-flow oxygen.

Circulation

Evaluate the pulse rate and volume, peripheral circulation (capillary refill time) and blood pressure.

- If signs of life are absent, initiate CPR.
- Perform the left lateral tilt or manual displacement of the uterus.
- If the patient shows signs of shock, support the circulation as described below.

Section 17: Shoulder dystocia

- Insert a 14- to 16G IV cannula and take 20 mL of blood for a full blood count, cross-matching (4 units = 2 litres) and clotting. Do a whole blood clotting time (WBCT) test if laboratory analyses are not available.
- Give 500 mL to 1 litre of Ringer-lactate or Hartmann's solution by rapid IV bolus.
- Reassess, and if shock is still present, give blood (if available) (500 mL as rapidly as possible after warming) or another 500 mL to 1 litre of Ringer-lactate or Hartmann's solution.
- If the patient is ketotic from prolonged obstructed labour, add 50 mL of 50% glucose to the second litre of Ringer- lactate or Hartmann's solution.
- Central venous access may be needed for volume replacement if peripheral access is not possible.

Emergency treatment

- 1 Obtain consent for laparotomy and hysterectomy.
- 2 Try to place a second IV cannula.
- 3 Perform urgent laparotomy under general anaesthesia.
- 4 The type of operation will depend upon the size and site of rupture, and the degree of haemorrhage.
- 5 Give IV prophylactic antibiotics (ampicillin 2 grams or cefuroxime 1.5 grams **plus** metronidazole 500 mg).

Shoulder dystocia

Shoulder dystocia is caused by impaction of the shoulders against the bony pelvis. The problem lies at the pelvic brim where the anterior shoulder gets caught, while the posterior shoulder has usually entered the pelvis. Treatment therefore aims to encourage the anterior shoulder into the pelvis, or if this fails, either rotating the posterior shoulder round into the anterior position or delivering the posterior arm first. Traction on the head when the anterior shoulder is caught above the pelvic brim will not work and is dangerous.

Delivery should occur within 5 minutes of the delivery of the head. The longer the delay, the greater the risk of hypoxic injury to the baby.

Postpartum haemorrhage is common after shoulder dystocia, and there is a risk of serious vaginal and perineal lacerations.

Slow progress in labour, particularly in the multiparous patient or in the woman with a past history of a big baby or difficulty delivering the shoulders, should alert one to the possibility of shoulder dystocia.

During delivery, signs include the following:

- difficulty delivering the face and chin
- head retractions between contractions
- head bobbing
- the delivered head becomes tightly pulled back against the perineum (turtle sign).

As soon as the situation is suspected, a plan of action should be initiated.

Management of shoulder dystocia

If risk factors are present, try if possible to have an experienced obstetrician present in the second stage of labour. However, 50% of cases are unexpected.

Be prepared for the problem, including postpartum haemorrhage, which may follow.

Try each manoeuvre for 30–60 seconds only: if it does not work, move on. Try to recognise it early on and before applying any traction to the head, which can delay helpful procedures and cause Erb's paralysis.

HELPER: H = Help

E = Evaluate/Episiotomy

L = Legs (McRoberts)

P = Pressure (suprapubic)

E = Enter (posterior arm and Wood's screw)

R = Rotate (on to all fours)

R = Repeat

- 1 *Call for help.* This condition needs the most experienced team and extra helpers.

Section 17: Shoulder dystocia

2 *McRoberts manoeuvre* (legs) (see Figures 17.5 and 17.6). Both thighs are sharply flexed, abducted and rotated outwards, ideally by two assistants. Each assistant holds the leg in the region of the thigh and flexes the leg until the thigh lies parallel to the anterior abdominal wall. This will reduce the angle between the sacrum and the lumbar vertebrae to help to free the impacted shoulder. If two assistants are not available, the mother may be placed in the all fours position (see below).

Figure 17.5 McRoberts manoeuvre, showing how important it is to fully flex both legs on to the mother's abdomen so that the thighs lie parallel to the anterior abdominal wall



Figure 17.6 In McRoberts manoeuvre, with only one assistant the left leg is held flexed against the abdomen by a nurse, and the mother holds her right leg in this position.

3 *Suprapubic pressure with moderate traction* (not fundal pressure). Suprapubic pressure is applied to reduce the diameter between the shoulders and push the anterior shoulder underneath the symphysis pubis. It is important to know where the fetal back lies, so that pressure is applied in the right direction (i.e. from the fetal back forwards towards the fetal chest). If you are unsure of the position of the back, confirm it by vaginal examination. Pressure should be applied to the back of the shoulder with the heel of the hand, and sometimes a rocking movement may be helpful. Strong traction and fundal pressure should be avoided.



Figure 17.7 Suprapubic pressure



4 *Apply moderate traction* (harder pulling can make impaction worse and cause Erb's paralysis). Once both McRoberts manoeuvre and suprapubic pressure are in place, moderate traction can be applied while discouraging maternal efforts (which can increase the impaction of the shoulders).

Section 17: Shoulder dystocia

5 *Consider an episiotomy.* A medio-lateral episiotomy is recommended to allow more room for manoeuvres such as delivering the posterior shoulder, allowing the operator to use the sacral hollow, and reducing vaginal trauma.

6 *Deliver the posterior arm and shoulder.* Insert a hand up to the fetal axilla and hook the posterior shoulder down. Traction on the posterior axilla then brings the posterior arm within reach. Run your index finger or middle finger, or both, along the back of the fetal humerus, then flex the elbow at the antecubital fossa, which will disengage the arm, which can then be brought down (hold the hand and sweep it across the chest). Sometimes it comes out directly lying alongside the head, and sometimes it comes out with an element of rotation anteriorly.

Figure 17.8 Delivery of the posterior arm

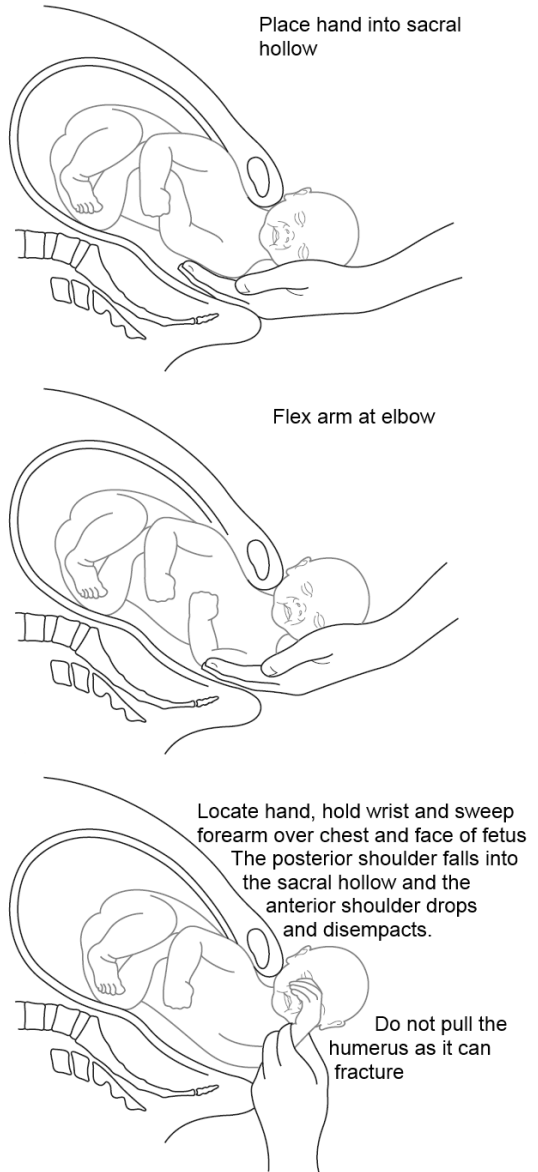

Section 17: Shoulder dystocia

7 *Internal rotational manoeuvres* (Rubin's and Wood's screw manoeuvres). These measures are rarely required.

Rubin's manoeuvre. The operator inserts the fingers of one hand vaginally, positioning the fingertips behind the anterior shoulder. The shoulder is then pushed towards the fetal chest.

Figure 17.9 Rubin's manoeuvre

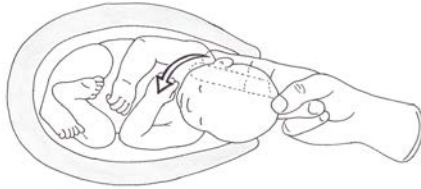

Wood's screw manoeuvre. If Rubin's manoeuvre is unsuccessful, the fingers of the opposite hand may be inserted vaginally to approach the posterior shoulder from the front of the fetus. The combination of these two movements may allow rotation of the shoulders and aid delivery. If delivery of the posterior shoulder or arm is not successful, try to rotate the posterior shoulder 180-degrees in a corkscrew fashion (clockwise or anticlockwise) to bring it to an anterior position, from which the delivery can continue as normal (this rotation releases the impacted anterior shoulder that ends up in the posterior pelvis). It is important not to twist the fetal head or neck during this manoeuvre.

Figure 17.10 Wood's screw manoeuvre

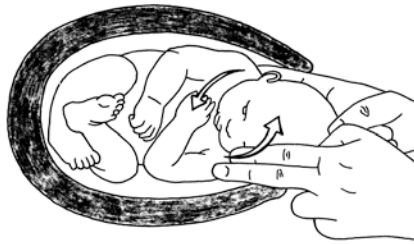
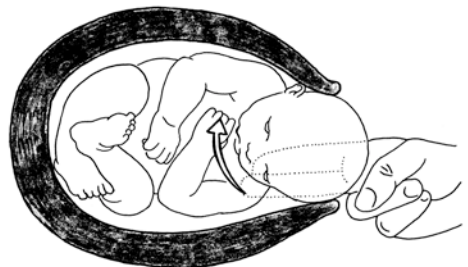

Figure 17.11 Reverse Wood's screw manoeuvre



8 *All fours position*. This can be useful if no help is available. The mother quickly positions herself evenly on hands and knees (Gaskin's manoeuvre). In many cases this alone relieves the dystocia. In addition, it can assist with the delivery of the posterior arm. The manoeuvres described above can also be performed with the mother in this position. Early on try to deliver the

Section 17: Shoulder dystocia

posterior shoulder from this position. Sometimes pushing one leg forward into the 'starting of a race' position can open up the pelvis from this position.



Figure 17.12 The all-fours position for shoulder dystocia (the method to use if you have no one to assist you). Guide the head downwards so that the posterior shoulder that has now become upwards with the adoption of the all-fours position is delivered.

- 9 Symphysiotomy. If the baby is still undelivered, symphysiotomy should be considered.
- 10 Check the vagina and perineum for trauma, and repair accordingly.
- 11 Prepare for postpartum haemorrhage.

Section 18: Severe infection after birth: puerperal sepsis

Section 18: Severe infection after birth

Symptoms	Signs	Investigation	Diagnosis	Treatment
History of Caesarean section Rigors, chills and/or malaise	High, swinging fever Swelling and redness around incision		Wound abscess	Surgical drainage
History of Caesarean section Rigors, chills and/or malaise Severe abdominal pain Vomiting	High fever Abdominal distension Rigid abdomen Absent bowel sounds Shock (see above for signs)		Peritonitis	Treat shock Give IV antibiotics and fluids Nasogastric tube Immediate laparotomy in operating theatre
Lower abdominal pain Diarrhoea History of Caesarean section	Swinging fever Swelling in adnexae or pouch of Douglas Tender uterus Ultrasound	Full blood count, including white blood cell count Blood culture Pus for microscopy culture and sensitivity	Pelvic abscess	Give IV antibiotics: Ampicillin 2 grams IV/IM every 6 hours plus gentamicin 80 mg IV/ IM every 8 hours or 5 mg/ kg body weight IV/IM once every 24 hours plus metronidazole 500 mg IV every 8 hours Surgical drainage
Pain in the lower abdomen or loin Nausea and/or vomiting Increased frequency of passing urine	High fever Tenderness of one of the loins over the kidney Normal bowel sounds	Microscopic examination of urine Stick tests for infection (if available) Urine culture	Pyelonephritis	IV antibiotics (see Section 38) If the patient is in shock, initiate immediate treatment
Difficulty in breathing Cough, sometimes with expectoration	Fever Respiratory distress Signs of consolidation or effusion	Chest X-ray Ultrasound if there is effusion	Pneumonia	IV antibiotics (see Section 34)
Rigors Headache Muscle and/or joint pains	Fever Enlarged spleen Shock Reduced consciousness Jaundice Anaemia Fitting	Full blood count Thick film for parasites Blood glucose	Malaria	Antimalarial drugs (see Section 36)

Section 18: Severe infection after birth: puerperal sepsis

Endometritis is infection of the genital tract at any time between the onset of rupture of the membranes or labour and the 42nd day following delivery or abortion, in which two or more of the following are present:

- abdominal and/or pelvic pain
- fever of $\geq 37.5^{\circ}\text{C}$ (can be masked by paracetamol or other antipyretic drugs)
- abnormal quantity of vaginal discharge
- foul-smelling discharge
- delay in the rate of involution of the uterus.

In the puerperium such sepsis can present with few symptoms (the woman feels unwell and usually has a fever). It can also progress rapidly to become life threatening within hours.

Treatment

Treat as an emergency, including IV fluid boluses if shock is present (see Section...), if there is persistent tachycardia (> 100 beats/minute), hypotension (systolic blood pressure < 90 mmHg), increased respiratory rate (> 25 breaths/ minute), confusion or disorientation, oliguria (< 30 mL/hour), rash or severe bradycardia (< 50 beats/minute).

Give antibiotics until the patient has been fever-free for 48 hours or 7–10 days:

- ampicillin 2 grams IV every 6 hours
- **plus** gentamicin 80 mg IV/IM every 8 hours or 5 mg/ kg body weight IV/IM once every 24 hours
- **plus** metronidazole 500 mg IV every 8 hours.

If fever is still present 72 hours after initiating antibiotics, re-evaluate the patient and consider revising the diagnosis.

Often a 1 to 2 week antibiotic course is completed orally once the patient has been fever free for 48 hours.

If retained placental fragments are suspected, perform a digital exploration of the uterus to remove clots and large pieces. Use ovum forceps or a large curette if necessary, but be very careful not to penetrate the uterine wall, which is very soft at this stage. Where general anaesthesia is not available, consider ketamine or morphine for this procedure.

If there is no improvement with conservative measures, and there are symptoms and signs of general peritonitis (abdominal pain, fever, and abdominal tenderness with rebound tenderness), perform a laparotomy to drain the pus, and if the uterus is the source do not leave it too late to perform a hysterectomy.

Wound infections post caesarean section

Wound infections may be superficial or deep. Superficial infections involve the skin and subcutaneous tissues, but not the rectus sheath (fascia). They may present with cellulitis or abscess formation. Cellulitis should be treated with antibiotics; this may prevent the development of a wound abscess.

Clear or purulent fluid exuding from the wound should raise concern that the infection is deep to the sheath. Where there is abscess formation, the wound should be opened by removing sutures to the skin and subcutaneous tissues, to allow drainage of pus. Antibiotics are not always required if an abscess is drained and the surrounding tissues appear healthy. The wound may require debridement if tissue necrosis is suspected. If the sheath looks healthy and intact, the fascial sutures should be left in situ. The wound should be packed with a damp dressing, which must be changed every 24 hours.

If the sheath appears necrotic or infected, it should be opened and the peritoneal cavity inspected for collections of pus. If pus is present, it should be evacuated, and a broad corrugated drain left in situ in the peritoneal cavity to facilitate drainage post-operatively.

Necrotising fasciitis is an uncommon but life-threatening variant of wound infection, which presents with rapidly spreading cellulitis, with severe pain and tenderness. Urgent wide debridement of necrotic tissue is required; with antibiotics as for deep wound infection (see below). Secondary closure should be undertaken 2–4 weeks later, provided that the infection has resolved.

Section 18: Severe infection after birth: puerperal sepsis

Antibiotic regimes for wound infections

Where possible, swabs should be taken for culture and sensitivity before starting antibiotics.

Superficial infections

Give ampicillin 500 mg by mouth, four times a day for 5 days, **plus** metronidazole 500 mg by mouth, three times a day for 5 days.

Deep infections

Give benzyl penicillin, 2 million units (1200 mg) IV every 6 hours, **plus** gentamicin 80 mg IV/IM every 8 hours or 5 mg/kg body weight IV/IM once every 24 hours, **plus** metronidazole 500 mg IV every 8 hours.

IV antibiotics should be continued until at least 48 hours after the pyrexia has settled.

The patient may then be switched to oral antibiotics, as described above.

Peritonitis

Treat shock, if present. Then:

- provide nasogastric suction
- infuse IV fluids for maintenance and replacement
- give antibiotics IV until the patient has been fever-free for 48 hours:
 - ampicillin/amoxicillin 2 grams IV/IM every 6 hours
 - **plus** gentamicin 80 mg IV/IM every 8 hours or 5 mg/kg body weight IV/IM once every 24 hours
 - **plus** metronidazole 500 mg IV every 8 hours.
- if necessary, perform a laparotomy to repair diseased or injured bowel.

Pelvic abscess

Give antibiotics before draining the abscess, and continue until the patient has been fever-free for 48 hours:

- ampicillin/amoxicillin 2 grams IV every 6 hours
- **plus** gentamicin 80 mg IV/IM every 8 hours or 5 mg/kg body weight IV/IM once every 24 hours
- **plus** metronidazole 500 mg IV every 8 hours.

If the abscess is fluctuant in the cul-de-sac, drain the pus through the cul-de-sac (culdocentesis) (see below). If the spiking fever continues, perform a laparotomy.

Bowel may be secondarily involved in the inflammatory process, and care must be taken to avoid bowel perforation. Peritonitis may develop in association with a pelvic abscess. Prompt nasogastric suction and administration of intravenous fluids are important, as well as IV antibiotic therapy as described above.

Culdocentesis and colpotomy

Culdocentesis for the detection of pus

- Apply antiseptic solution to the vagina, especially the posterior fornix.
- Infiltrate with 1% lignocaine.
- Gently grasp the posterior lip of the cervix with a tenaculum and gently pull to elevate the cervix and expose the posterior vagina.
- Place a long needle (e.g. spinal needle) on a syringe and insert it through the posterior vagina, just below the posterior lip of the cervix (see Figure 18.1).
- Pull back on the syringe to aspirate the cul-de-sac (the space behind the uterus).
- If pus is obtained, keep the needle in place and proceed to colpotomy (see below).

Figure 18.1 Culdocentesis: diagnostic needle aspiration of the cul-de-sac

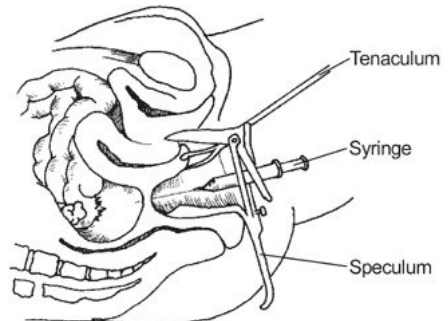

Section 18: Severe infection after birth: puerperal sepsis

Colpotomy for draining a pelvic abscess

If pus is obtained on culdocentesis, keep the needle in place and make a stab incision at the site of the puncture. Remove the needle and insert blunt forceps or a finger through the incision to break the loculi in the abscess cavity (see Figure 18.2).

- Allow the pus to drain.
- Insert a disinfected soft rubber corrugated drain through the incision. (If a surgical drain is not available, a make- shift drain can be prepared by cutting off the fingertips of a disinfected rubber glove.)
- If required, use a stitch through the drain to anchor it
- in the vagina.
- Remove the drain when there is no more drainage of pus.
- If no pus is obtained, the abscess may be higher than the pouch of Douglas. A laparotomy will be required for peritoneal lavage (wash-out).

Figure 17.2 *Colpotomy* for pelvic abscess

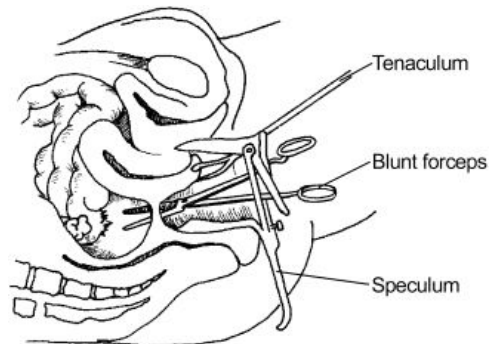

Mastitis

Treatment

The milk from the affected breast is safe for the baby to drink. Breastfeed frequently on the affected side, in order to empty the breast of retained milk. The baby can empty the breast more efficiently than a breast pump. However, if the baby is not feeding well, a breast pump or hand expression will be needed to get the milk out.

Mastitis can usually be successfully treated by resting, drinking plenty of fluids and varying the baby's position at the breast. It is important to ensure that the baby is properly attached to the nipple, and that the breast is empty after the feed. It may be necessary to feed more frequently, and to express the remaining milk after a feed.

Paracetamol is useful for pain control.

Antibiotic treatment. The bacterium in mastitis is usually *Staphylococcus aureus*, and the two most effective antibiotics are cloxacillins and cephalosporins, which are safe to take while breastfeeding. A 10-day oral course is recommended.

Section 19: Pulmonary embolism

Section 19: Pulmonary embolism

If left untreated, as many as 24% of patients with deep vein thrombosis (DVT) will have a pulmonary embolism. However, when DVT is treated with anticoagulants (if that is possible), pulmonary embolism occurs in only 4.5% of cases, and the mortality rate is less than 1%.

Clinical presentation

- Dyspnoea, tachypnoea, pleuritic chest pain, cough, haemoptysis and leg pain.
- Massive pulmonary embolism may be associated with cyanosis, circulatory collapse with hypotension, syncope or convulsions and central chest pain.
- Occasionally, patients present with unexplained tachycardia.

Tachycardia and a few localised crepitations may be the only findings on physical examination. Massive pulmonary embolism may produce right-sided heart failure with jugular venous distension, an enlarged liver, a left parasternal heave, and fixed splitting of the second heart sound.

Clinical evidence of DVT may not be found in patients with pulmonary embolism. Symptoms and physical findings must be interpreted with caution during pregnancy, because dyspnoea, tachypnoea and leg discomfort are common findings as pregnancy progresses.

Primary assessment and resuscitation for possible pulmonary embolism (ABC approach)

Call for help.

Airway

- Use an opening manoeuvre if the airway is not open or is partially obstructed. If there is an improvement, use airway adjuncts to maintain the airway. An oropharyngeal airway is usually appropriate only if the patient is unconscious.
- Suction if necessary.
- The airway may need to be maintained and protected by intubation.

Breathing

- Provide a high concentration of oxygen through a face mask with reservoir bag, if there is adequate spontaneous respiration.
- For patients with inadequate ventilation or depressed conscious level, respiration should be supported with oxygen via a bag-valve-mask and experienced senior help summoned (if available).

Give 100% oxygen (mask with reservoir and high flow rate) regardless of SaO₂.

Circulation

- Place a wide-bore IV cannula (16- to 18G).
- Place the woman in a lateral tilt if undelivered and more than 20 weeks' gestation or recovery position if unconscious.
- Treat clinically suspected pulmonary embolism while awaiting confirmation from objective tests (if available) to prevent further thromboembolic complications and extension of the existing thrombus.
 - Initiate treatment with an IV bolus of 5000 IU of unfractionated heparin over 5 minutes.

Note: there are serious potential risks of anticoagulation, in particular the risk of life-threatening haemorrhage in the 24 hours after delivery, especially after Caesarean section.

Empirical anticoagulation should be undertaken only when the diagnosis is clinically probable.

Secondary assessment and emergency treatment

Involve the senior obstetrician, the anaesthetist and the medical team (if available).

Subsequent anticoagulation for pulmonary embolus and/or deep vein thrombosis (DVT)

Heparin is the anticoagulant of choice in pregnancy, as it does not cross the placenta. Rapid and prolonged anticoagulation prevents extension of the thrombus and its recurrence.

When available, acute therapy is with an IV bolus of unfractionated heparin, 5000 IU over 5 minutes as described above, followed by an IV infusion of 1000–2000 IU/hour for 5–10 days. The dose is adjusted to maintain the activated partial thromboplastin time (APTT) at 1.5–2.5 times the control. Repeat the APTT every 6 hours during the first 24 hours of therapy, and thereafter monitor it daily.

Section 19: Pulmonary embolism

Treatment may then be continued with subcutaneous heparin at a dose of 10,000 IU twice daily.

Maintaining the APTT in the therapeutic range (1.5–2.5 times the control) following subcutaneous heparin may be problematic, and can lead to under- or over-anticoagulation.

Low-molecular-weight heparin (LMWH) such as enoxaparin is ideal if available and is given subcutaneously. This drug is available in syringes of 40, 60, 80 and 100 mg. The dose should be based on the patient's pre-pregnancy weight and should be given 12-hourly. The dose will vary depending on the drug used, but for enoxaparin is 1 mg/kg 12 hourly (note this is a greater total dose than the non-pregnancy dose of 1.5 mg/kg/24 hours). If coagulation tests are available, the aim is to achieve an APTT of 1.5–2.5 times the pre-treatment level. If these tests are not available, careful monitoring for signs of overdose, which can cause haemorrhage, should be undertaken and the mother should be warned of the symptoms to be alert for. The mother can be discharged when taught how to administer the injections and dispose safely of the needles.

Before giving heparin, measure the platelet count (if available). Rare complications of heparin treatment are allergy and thrombocytopenia. The platelet count should be monitored at the onset of treatment and monthly thereafter.

Can a patient be anticoagulated with heparin if APTT is not available? You will need to weigh the risks of not treating against the risks of treating. The only good thing is that the half-life of heparin is short (a few hours). If the diagnosis is uncertain and/or the risk to the patient is low, do not give heparin.

On entering labour, the mother should not be given any further doses of LMWH. If an elective Caesarean section is planned, the mother should have the usual dose of LMWH on the night before surgery, but the morning dose should be omitted. After delivery, as long as there are no concerns about bleeding, enoxaparin should be restarted 4 hours after a vaginal delivery and 8 hours after a Caesarean section. A once daily regimen may be used, especially after 3 days when concerns about haemorrhage are much reduced.

Warfarin crosses the placenta and damages the fetus in the first trimester. Major fetal CNS abnormalities such as microcephaly and optic atrophy are also seen with warfarin used in the second and third trimesters. In addition, there is a higher risk of intra-cerebral bleeds from the trauma of delivery, and a higher risk of bleeding complications during labour and delivery. **For all these reasons, warfarin should not be given in the antenatal period.** However, warfarin can be initiated **in the postpartum period** and overlapped with heparin until the INR is maintained at 2.0–3.0.

Anticoagulation following pulmonary embolism or DVT should be continued throughout pregnancy and for at least 3 months postpartum.

All women at high risk of DVT or pulmonary embolism (e.g. those who have suffered these conditions before, in this or a previous pregnancy) should use anti-embolism stockings and receive subcutaneous heparin until they are fully mobile.

Section 20: Amniotic fluid embolism

Section 20: Amniotic fluid embolism

Amniotic fluid embolism usually presents late in the first stage of labour. It has also been reported during first-trimester surgical termination of pregnancy, second- trimester termination, after abdominal trauma and after amniocentesis.

The diagnosis is essentially clinical and by exclusion and treatment of other possible more treatable causes.

The major signs include the following:

- acute hypotension or cardiac arrest
- acute hypoxaemia (dyspnoea, cyanosis or respiratory arrest)
- coagulopathy (laboratory evidence of DIC or fibrinolysis or severe clinical haemorrhage) if the patient survives long enough for DIC to become established (more than 30 minutes)
- the absence of other causes or symptoms.

Management

Management is supportive, and aims to correct hypoxaemia, shock and coagulopathy and its consequences.

- Give 100% inspired oxygen by face mask and reservoir.
- If the patient is unconscious (P or U on the AVPU scale), intubation and assisted ventilation (if available) are needed.
- High positive end-expiratory pressure (PEEP) should be avoided.
- Two large-bore cannulae (16G) IV should be sited.
- Urgently cross-match blood, ideally at least 6 units of group-specific blood with retrospective cross-matching (if available) should be ordered. Check clotting factors (or clotting time) and platelets. Blood needs to be sent for a full blood count, clotting, fibrinogen and fibrinogen deg- radation product (FDP) levels (if available) immediately, and frequent repeated estimations of haematological parameters are required (if available).
- Cardiac arrest is managed according to protocols (see Section 8).
- If the woman is in labour, immediate delivery is required, by Caesarean section (under general anaesthetic) if vaginal delivery is not imminent. In cardiac arrest, if a cardiac output cannot be restored immediately, cardiac massage and ventilation should continue and Caesarean section should be performed.
- In patients who survive the initial haemodynamic collapse, there is a high risk of secondary pulmonary oedema (70%). Inotropic support, ideally guided by monitoring of the central venous pressure (CVP), may be helpful.
- If massive obstetric haemorrhage occurs, large volumes of fresh blood and blood products may be required.
- Correct coagulopathy with fresh blood, platelets, fresh- frozen plasma and cryoprecipitate (rich in fibrinogen) if available.
- Massive haemorrhage may be due not only to coagulopathy, but also to coexisting uterine atony. Oxytocic drugs will be needed. Uterine tamponade may reduce blood loss while the coagulopathy is corrected.
- Patients who survive are at high risk for heart failure, ARDS and DIC. If the patient is sustaining a cardiac arrest, there is a high risk of neurological injury. As in other cardiac arrests associated with pregnancy, delivery may improve the success of resuscitation.

Outcome

The outcome is poor, even when optimum treatment and monitoring is available, so it is important to exclude other possible and treatable causes of collapse, including anaphylaxis, pulmonary embolism, haemorrhage, sepsis, myocardial infarction, eclampsia, intracranial haemorrhage, hypoglycaemia and drug toxicity (e.g. magnesium, local anaesthetics).

Section 21: Reduced fetal movements and fetal death

Section 21: Reduced fetal movements

Table 21.1 Diagnosis of reduced fetal movements

Symptoms	Signs	Investigation	Diagnosis	Treatment
Decreased or absent fetal movements Bleeding (but may not be external) Collapse Severe constant abdominal pain	Shock in the mother Tense and/or tender uterus Fetal distress or absent fetal heart sounds	Pinard's stethoscope, Doppler device or ultrasound scan	Placental abruption	Deliver the baby as soon as possible (see below) by Caesarean section if there are signs of fetal life
Decreased or absent fetal movements Bleeding (but may not be external) Collapse Severe constant abdominal pain	Shock in the mother Diffuse uterine tenderness with easily felt fetal parts Fetal distress or absent fetal heart sounds	Pinard's stethoscope, Doppler device or ultrasound scan	Ruptured uterus Major risk factors are prolonged labour, previous Caesarean section and use of oxytocin	Treat shock When the mother is stable perform laparotomy
Decreased or absent fetal movements If membranes are ruptured, meconium staining of liquor	Abnormal fetal heart rate (< 100 beats/minute or > 180 beats/minute)	Pinard's stethoscope, Doppler device or ultrasound scan Partogram should show alerts	Fetal asphyxia	Deliver the baby as soon as possible (see below) by Caesarean section if there are signs of fetal life
Absent fetal movements	Symphysis-fundal height decreases Absent fetal heart rate If membranes are ruptured, meconium staining may be present	Pinard's stethoscope, Doppler device or ultrasound scan Full blood count in mother Clotting screen, including measurement of platelet count	Fetal death	Deliver baby as soon as possible (see Textbook)

Check for fetal heart sounds, and if they are present, measure the fetal heart rate.

If the fetal heart cannot be detected with a Pinard's stethoscope, Doppler device or ultrasound scan, refer to Table above.

Details of diagnosis, management and prevention are provided in the Textbook.

Section 22: Fetal distress during labour

In all clinical circumstances, the well being of the pregnant woman takes precedence over that of the unborn baby, and usually resuscitation of the mother will automatically benefit the fetus. Careful thought has to be given to the assessment and management of the fetal condition in labour. See the Textbook for more details.

Abnormalities of the fetal heart rate

Tachycardia: This is a fetal heart rate above 160–170 bpm. A tachycardia is often caused by a maternal pyrexia or tachycardia and in these instances it will often resolve once the maternal observations have normalised.

Decelerations: A deceleration is a reduction in the fetal heart rate 15 bpm or more below the base line for 15 seconds or more.

An early deceleration occurs at the onset of the contraction and recovers by the end of the contraction. It is a common feature during labour (especially the second stage) and is not usually associated with fetal distress.

A late deceleration starts during or at the end of a contraction and persists beyond the end of the contraction. This is more commonly associated with fetal distress and if it occurs the fetal heart should be monitored following the next 2 contractions to see if it recurs. If it does, there is a significant chance that the fetus is distressed.

Bradycardia: A bradycardia is a deceleration that continues for over 3 minutes. It may occur during pregnancy or labour and may be associated with inferior veno-caval compression if the patient is lying supine, sudden drops in blood pressure from any cause or cord compression. It may also represent the end stage of a prolonged period of fetal distress. If the cause of the bradycardia is self-limiting, then the fetal heart should recover, whereas if it has occurred due to period of prolonged distress or the insult is ongoing, it will not recover and will end in fetal death. Even if it resolves, a bradycardia of over 10 minutes may cause brain damage to the fetus and have implications for the neonate.

Clinical assessment of fetal well-being

History

- Gestational age is important, as an immature fetus withstands the stresses of labour less well than if it had reached term. Similarly, those with intrauterine growth retardation are at risk.
- A reduction in fetal movements should always give rise to concern, as it may reflect fetal distress (see section 21).
- Pre-eclampsia, antepartum haemorrhage (APH), preterm pre-labour rupture of membranes (PPROM) or other obstetric or medical problems, prolonged pregnancy, multiple pregnancy, diabetes and previous Caesarean section all increase the risk of fetal distress.
- The use of oxytocin, a maternal fever, meconium- or blood-stained liquor, and prolonged first and second stage of labour also increase the risk.
- The duration of labour at the time of admission is crucial, as obstructed labour is a potent cause of severe maternal and fetal morbidity and mortality.

Examination of the maternal abdomen

- Fetal size: small or large for dates.
 - Amniotic fluid volume: oligohydramnios (too little) or polyhydramnios (too much).
 - Oligohydramnios is often associated with poor fetal growth. Growth-restricted fetuses are more likely to become distressed in labour than are well-grown fetuses.
 - Polyhydramnios may be associated with fetal abnormalities or fetal infection in utero.
 - Abdominal tenderness with or without hardness feeling like wood: consider placental abruption.
 - Colour of amniotic fluid after rupture of membranes:
 - bloodstained: consider placental abruption
 - meconium-stained: consider the possibility of a hypoxic episode causing fetal distress.
- (a) Passage of meconium is often a physiological (normal) phenomenon in a mature fetus.

Section 22: Fetal distress during labour

- (b) In the presence of plentiful amniotic fluid, the meconium will be dilute. Where there is little fluid, it will be thick.
- (c) Meconium may signal fetal distress. It may also cause neonatal respiratory problems through meconium aspiration, which occurs when a distressed fetus gasps in utero or during delivery.
- (d) During the final stages of a breech delivery, meconium may be passed because of the compression of the fetal abdomen. In this case, passage of meconium is not necessarily a sign of fetal distress.
- Frank blood loss vaginally: consider placental abruption, uterine rupture, placenta praevia and vasa praevia.
 - Haematuria in labour: this may signal uterine rupture, usually in association with severe abdominal pain and tenderness, commonly in a woman with a previous Caesarean section scar or in a woman of high parity, particularly where labour is induced or augmented.

Management of fetal distress

- If fetal distress is suspected, attention should first be paid to detecting and treating maternal factors, including hypovolaemia, sepsis, obstructed labour and uterine rupture.
- The woman should be turned (tilted) on her left side, to prevent aorto-caval compression.
- Facial oxygen should be administered at a high flow rate.
- Oxytocin should be discontinued if ongoing, and if still detected in situ, misoprostol tablets may be removed from the vagina.
- Antibiotic therapy will be indicated if infection (including chorio-amnionitis) is suspected.
- Vaginal examination should be performed to assess the feasibility of vaginal delivery, either spontaneously or by using forceps or ventouse.
- If suspected fetal distress continues despite the above measures and vaginal delivery is not rapidly achievable then a decision about whether to proceed to Caesarean section needs to be made. This is a difficult decision, which ideally takes into consideration a number of factors including: the obstetric history and wishes of the patient, the availability of neonatal care, the degree of fetal compromise suspected and the speed with which Caesarean section can be performed, the availability of hospital care and Caesarean section in subsequent deliveries, and the presence/absence of other relative indications for Caesarean section.
- If a decision is made to deliver by Caesarean section and a delay is anticipated (> 30 minutes), then a tocolytic such as terbutaline 250 microgram subcutaneously may be beneficial if the contractions are felt to be contributing to the fetal distress.

Section 23: Multiple births

Multiple pregnancies are associated with higher risks for both the mother and the fetus. Ultrasound scanning should be undertaken if the uterine size is larger than expected, or if abdominal examination of fetal parts leads to suspicion of multiple fetuses.

If ultrasound scanning facilities are not available, abdominal examination after delivery of any first baby should be performed to exclude a second twin before Oxytocin or Syntometrine is given to aid delivery of the placenta.

If a twin pregnancy is diagnosed, additional care should be provided. Iron and folate treatment must be ensured, due to the increased risk of anaemia. Preterm labour and delivery present the greatest risk of fetal illness and death. If the mother develops premature labour, a course of antenatal steroid injections should be given, betamethasone 12 mg IM, two doses 24 hours apart, or dexamethasone 6 mg IM four doses 12 hours apart.

Figure 23.1 The range of different twin positions in utero at birth

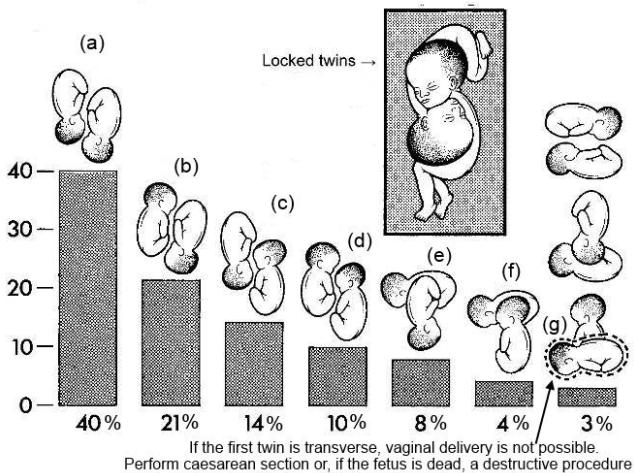

Twin delivery

Vaginal delivery is usually safe, but must be undertaken in a healthcare facility where comprehensive emergency obstetric care is available. If labour has not started by 39–40 weeks' gestation based on an accurate LMP or first trimester ultrasound, consider induction.

Management during labour

Delivery of first twin

- 1 Insert an IV cannula. Maternal blood should be obtained for a full blood count and blood grouping. A blood sample should be kept for cross-matching.
- 2 Ensure that the lie of the first baby is longitudinal.
- 3 Augment contractions only when indicated.
- 4 Prepare two delivery packs with extra clamps. Remember that there are almost always two membranes to rupture with twins, so have an amnio-hook ready.
- 5 Make sure that the cervix is fully dilated.
- 6 Empty the mother's bladder.
- 7 Deliver the first baby as normal.
- 8 Always clamp the maternal end of the cord of the first twin to prevent the second twin bleeding from it.
- 9 As the first baby is delivered, stabilise the lie of the second twin to a longitudinal position by asking an assistant to place their palms firmly on either side of the uterus in a longitudinal direction. The baby's position should be stabilised in this way until the head or

Section 23: Multiple births

buttocks are fixed in the maternal pelvis. If the second twin is not longitudinal on assessment, undertake version (see below).

10 Tie a marker (e.g. gauze) to the clamp on the cord of the first baby to identify it.

Delivery of second twin

- 1 The second baby should preferably be born within 30 minutes.
- 2 Check the fetal heart rate of the second baby.
- 3 Stabilise the lie of the second twin, by external version if necessary (see above).
- 4 Provided the lie is longitudinal and contractions do not restart 5–10 minutes after delivery of the first baby, start an oxytocin infusion, increasing carefully to achieve adequate contractions. Note that contractions may not be felt by the mother, so it is important to keep your hand on the uterus to identify them.

5 When the presenting part is well into the pelvis, rupture of the membranes can be performed during a uterine contraction.

6 Delivery of the second baby should not be rushed, but assisted delivery should be considered if the second baby has not been delivered by 30 minutes after delivery of the first.

7 If the lie of the second twin is transverse, attempt external version.

8 If external version is successful, or the second twin is longitudinal, wait for the presenting part to enter the pelvis, then perform artificial rupture of membranes (ARM) and allow normal cephalic or breech delivery if there is no fetal distress.

9 If external cephalic version is unsuccessful, either carry out internal version with breech extraction or perform a Caesarean section.

Internal podalic version: It is essential that as the baby descends, rotation of the fetus is encouraged to obtain a back-up (back anterior) position (as in breech delivery). Grasp a fetal foot; the one most likely to keep the fetal back anterior. Make sure that it is a foot, not a hand. Pull gently down into the birth canal so that the fetal back is encouraged to turn anteriorly. An attempt is made to pull the fetal foot as gently as possible in an attempt to pull it as low as the vulva before the membranes rupture. It may be that maternal effort will be sufficient once the baby's leg has been brought down into the vagina and the remainder of the delivery can then be managed as for an assisted breech delivery. Continued traction (avoiding soft tissues as for all breech deliveries) is permissible in this scenario, to facilitate descent of the buttocks, arm and head (breech extraction, see Figure 23.2).

Figure 23.2 Internal version for transverse lie in a second twin

10 If there is fetal distress or delay, perform an assisted vaginal delivery if cephalic. Note that

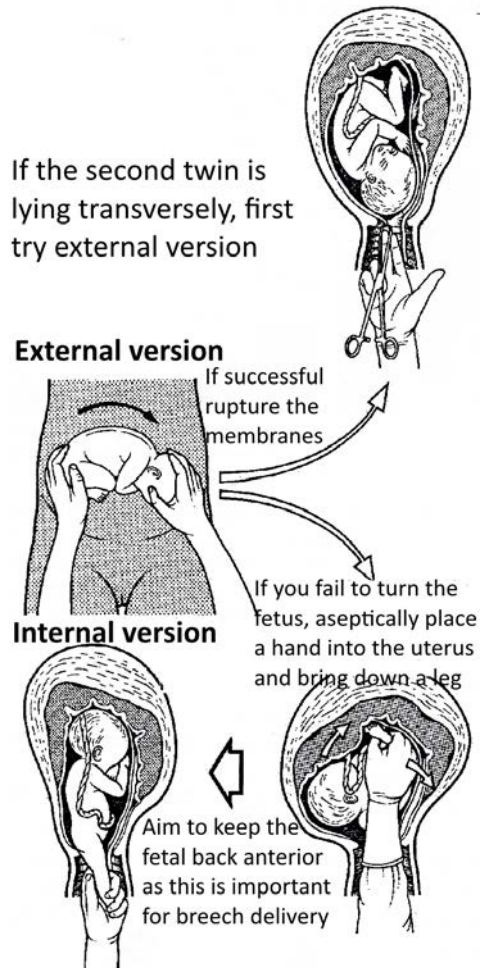

Section 23: Multiple births

cephalo-pelvic disproportion is very uncommon in the case of the second twin.

Postpartum management of a twin birth

- 1 After the birth of the second baby, give 10 IU oxytocin IM after ensuring that there is no third baby in the uterus. Then give oxytocin 40 units IV in 500 mL of Ringer-lactate or Hartmann's solution over 4 hours, to reduce the risks of postpartum haemorrhage due to atonic uterus.
- 2 Deliver the placenta by controlled cord traction after giving oxytocin IM.
- 3 After the placenta and membranes have been delivered, examine and record on the chart the number of placentas, amnions, chorions and cord vessels. Check the placenta and membranes for completeness.
- 4 Check and repair any vaginal and perineal damage.
- 5 Monitor the mother carefully for postpartum bleeding over the next few hours.
- 6 Provide extra support to assist with the care of the babies.
- 7 At least a 24-hour stay in hospital is required.
- 8 Observe vaginal bleeding closely, because of the risk of postpartum haemorrhage.

Section 23: Multiple births

Figure 23.3 Pathway of care for the delivery of twins

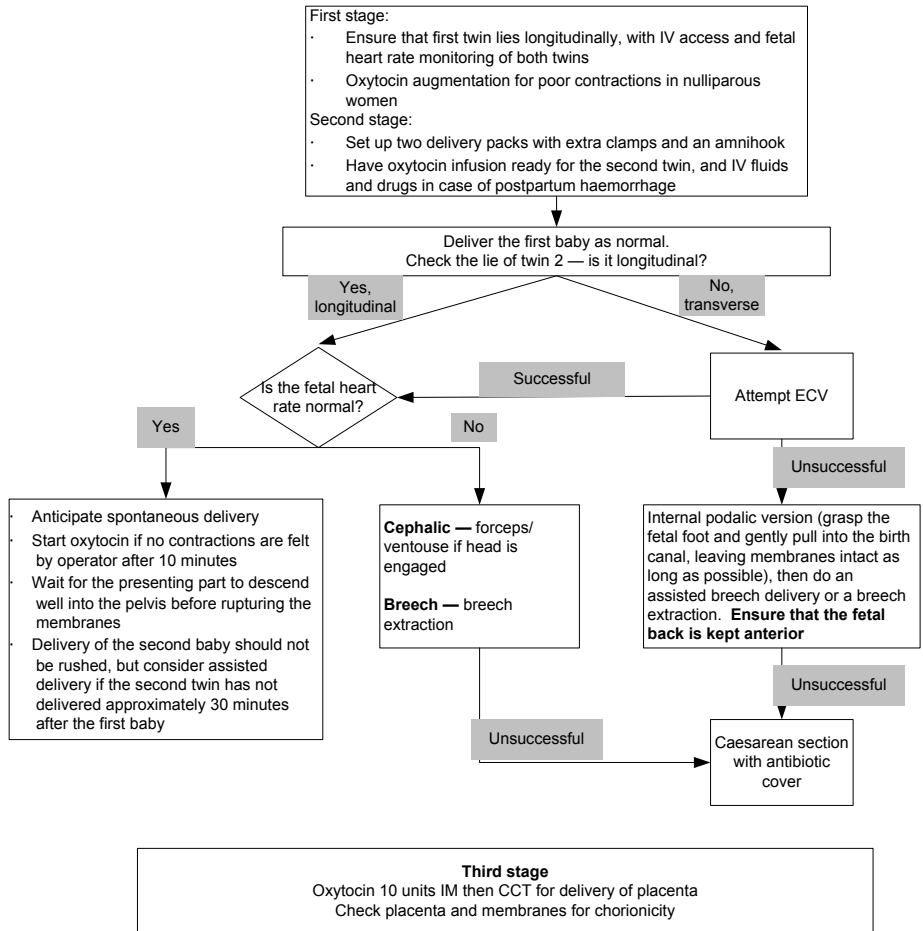

Section 24: Mal-positions and mal-presentations including breech delivery

Mal-presentations and mal-positions can be due to maternal pathology (e.g. contracted pelvis, uterine fibroids) or fetal pathology (e.g. hydrocephalus), which ideally should be diagnosed antenatally. Most often there is no apparent cause.

Mal-positions are abnormal positions of the vertex of the fetal head (with the occiput as the reference point) relative to the maternal pelvis.

Mal-presentations are all presentations of the fetus other than a vertex presentation (e.g. face presentation, breech presentation).

A fetus in an abnormal position or presentation may result in prolonged or obstructed labour.

Management

Review the progress of labour using a partograph (see Section 17). Observe the mother closely. Mal-presentations increase the risk of uterine rupture because of the potential for obstructed labour.

Assessment of the fetal position

Determining the presenting part. The most common presentation is the vertex of the fetal head. If the vertex is the presenting part, use landmarks of the fetal skull to determine the position of the fetal head (see Figure 24.1). However, although the anterior fontanelle is larger than the posterior one and has four sutures leading from it, one of these is small and may be difficult to feel.

Figure 24.1 The fetal skull

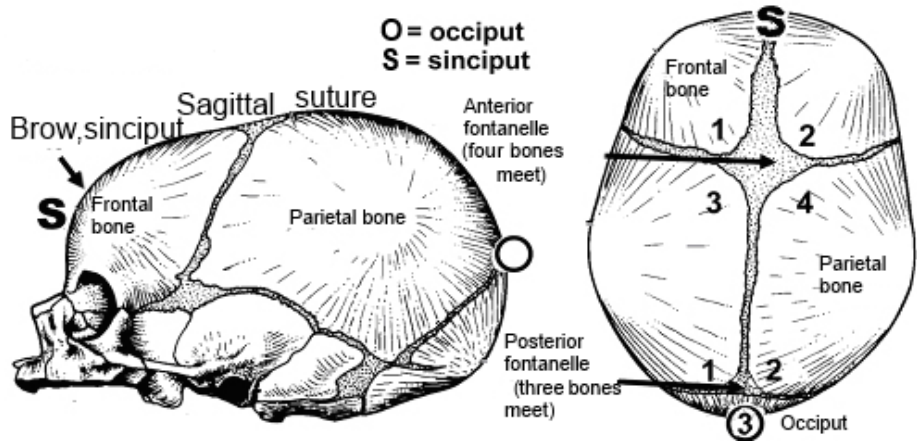

The fetal head normally engages in the maternal pelvis in an occiput transverse position. With descent, the fetal head rotates so that the fetal occiput is anterior in the maternal pelvis (see Table 24.1). Failure of an occiput to rotate to an occiput anterior position results in a persistent transverse presentation. Rotation may also occur to an occiput posterior position.

An additional feature of a normal presentation is a well-flexed vertex (see Figure 24.2), with the fetal occiput lower in the vagina than the sinciput.

Section 24: Malpositions and Malpresentations

Figure 24.2 Well flexed vertex

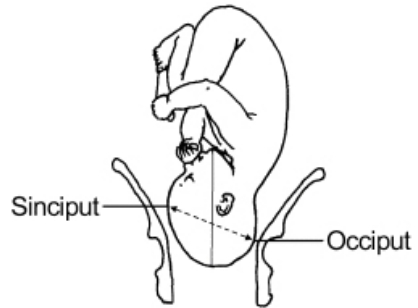
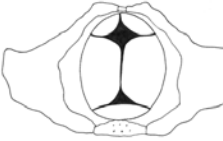
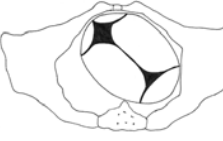



Table 24.1 Mal-positions and mal-presentations

Position	Observations	Picture from introitus
<i>Malpositions</i>		
Occiput anterior	On vaginal examination provided that the head is flexed only the posterior fontanelle with three sutures entering it is felt	<p>Diagram showing the occiput anterior presentation from the introitus. The occiput is at the top, and the anterior fontanelle is visible with three sutures entering.</p> <p>Occiput anterior</p>
		<p>Diagram showing the left occiput anterior presentation from the introitus. The occiput is on the left side, and the anterior fontanelle is visible with three sutures entering.</p> <p>Left occiput anterior</p>
		<p>Diagram showing the right occiput anterior presentation from the introitus. The occiput is on the right side, and the anterior fontanelle is visible with three sutures entering.</p> <p>Right occiput anterior</p>

Section 24: Malpositions and Malpresentations

Position	Observations	Picture from introitus
<i>Mal-positions</i>		
Occiput posterior	<p>On vaginal examination, the posterior fontanelle is towards the sacrum and the anterior fontanelle may be easily felt if the head is deflexed</p> <p>On abdominal examination the lower part of the abdomen is flattened, and the fetal limbs are palpable anteriorly</p>	 <p>Occiput posterior</p>  <p>Left occiput posterior</p>
<i>Mal-presentations</i>		
<p>Brow presentation is caused by partial extension of the fetal head so that the occiput is higher than the sinciput</p>	<p>On abdominal examination, more than half of the fetal head is above the symphysis pubis, and the occiput is palpable at a higher level than the sinciput</p> <p>On vaginal examination, the anterior fontanelle and the orbits are felt</p>	



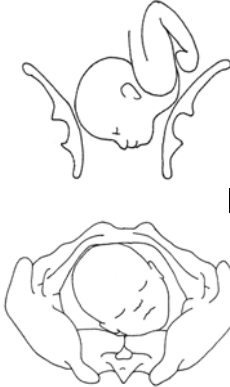
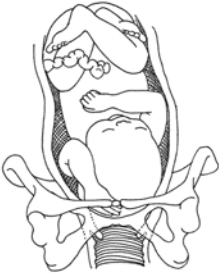

Section 24: Malpositions and Malpresentations

Presentation	Observations	Picture from introitus
<p>Face presentation is caused by hyper-extension of the fetal head so that neither the occiput nor the sinciput are palpable on vaginal examination</p>	<p>On abdominal examination, a large amount of head is palpable on the same side as the back, without a cephalic prominence on the same side as the limbs</p> <p>On vaginal examination, the face is palpated, the examiner's finger enters the mouth easily and the bony jaws are felt</p>	
<p>Compound presentation occurs when an arm prolapses alongside the presenting part</p>	<p>Both the prolapsed arm and the fetal head present in the pelvis simultaneously</p>	

Section 24: Malpositions and Malpresentations

Presentation	Observations	
<p>Transverse lie and shoulder presentation</p>	<p>The fetus lies in the transverse position with usually the shoulder presenting</p> <p>On abdominal examination, neither the head nor the buttocks can be felt at the symphysis, and the head is usually in the flank</p> <p>On vaginal examination, a shoulder may sometimes be felt. An arm may prolapse and the elbow, arm or hand may be felt in the vagina</p>	

Section 24: Malpositions and Malpresentations

Presentation	Observations	
<p>Breech presentation occurs when the buttocks and/or the feet are the presenting parts</p>	<p>On abdominal examination, the head is felt in the upper abdomen and the breech in the pelvic brim. Auscultation locates the fetal heart higher than expected with a vertex presentation</p> <p>On vaginal examination during labour, the buttocks and/or feet are felt; thick, dark meconium is normal</p>	 <p>extended legs</p>  <p>flexed legs</p>  <p>footling</p>  <p>a single footling presentation</p>

Management of mal-positions

Occiput-posterior positions

Around 15–20% of term cephalic fetuses are in an occiput- posterior (OP) position before labour, and approximately 5% are OP at delivery. Most fetuses (around 90%) rotate to the occiput-anterior (OA) position, some maintain a persistent OP position, and others rotate from an OA to an OP position during labour and delivery.

Arrested labour may occur when the head does not rotate and/or descend. Delivery may be complicated by perineal tears or extension of an episiotomy because an instrumental delivery is performed or because a persistent OP presentation requires passage of a greater diameter. The newborn infant is more likely to need resuscitation.

Diagnosis of an OP position in the second stage is generally made by digital examination, but if there is uncertainty, ultrasound examination is both useful and accurate in the right hands.

Management

There is no effective method of facilitating rotation from OP to OA before labour begins.

First stage of labour

Manual rotation (see below) must not be attempted in the first stage of labour, as it can lead to a prolapsed cord or complex presentations (e.g. hand). It is also technically more difficult and may introduce infection.

1. If there are signs of obstruction or the fetal heart rate or pattern is abnormal (< 110 beats/minute or > 160 beats/minute, or abnormal dips) at any stage, deliver by Caesarean section if this can be safely undertaken.
2. If the membranes are intact, rupture them.
3. If there are no signs of obstruction, augment labour with oxytocin.

Second stage of labour

If the cervix is fully dilated:

- If the fetal head is more than 3/5 palpable above the symphysis pubis, or the leading bony edge of the head is above -2 station and there is fetal distress and/failure to descend, perform a Caesarean section.
- If the fetal head is less than 3/5 above the symphysis pubis, or the leading bony edge of the head is between 0 station and -2 station, try manual rotation (see below) if there is no clear progress in the second stage with an OP position after 30 minutes of pushing.

However, expectant management of the OP position is appropriate in the presence of a reassuring fetal heart rate, adequate space on clinical examination of the pelvis, and continued progress in the second stage. More than 50% of multiparous women and more than 25% of nulliparous women with persistently OP fetuses achieve spontaneous vaginal delivery.

Therefore it is not appropriate to routinely perform prophylactic rotation at the beginning of the second stage of labour.

Delivery from an OP position rather than rotation (see below) is more appropriate in women who, on clinical examination, are found to have ample room between the fetal occiput and the maternal sacrum/coccyx, and when the pelvis is too narrow to permit anterior rotation (women with an anthropoid pelvis with a narrow transverse diameter, and women with an android pelvis with a narrow arch).

Section 24: Occipito posterior position

Manual rotation

Successful rotation after the onset of the second stage of labour is more likely to be successful if it is performed before arrest occurs. Manual rotation can convert 90% of OP or transverse arrest situations to OA.

Manual rotation is more successful in multiparous women and young women. Rotation is important if there is a need for a fast delivery and/or if there is minimal or slow descent after a trial of pushing.

First empty the bladder.

There are two methods for rotating the fetus.

1. **Finger rotation.** A hand is inserted into the vagina with the palm upward. Digital rotation is performed by placing the tips of the index and middle fingers in the anterior segment of the lambdoid suture near the posterior fontanelle (see Figure 24.3).

The fingers are used to flex and slightly dislodge the vertex, rotating the fetal head to the OA position by rotation of the operator's hand and forearm. The thumb may also be used with gentle downward pressure more anteriorly on the parietal bone to aid this rotation. **The fetal head should be held in place for a few contractions to prevent rotation back towards the posterior position.**

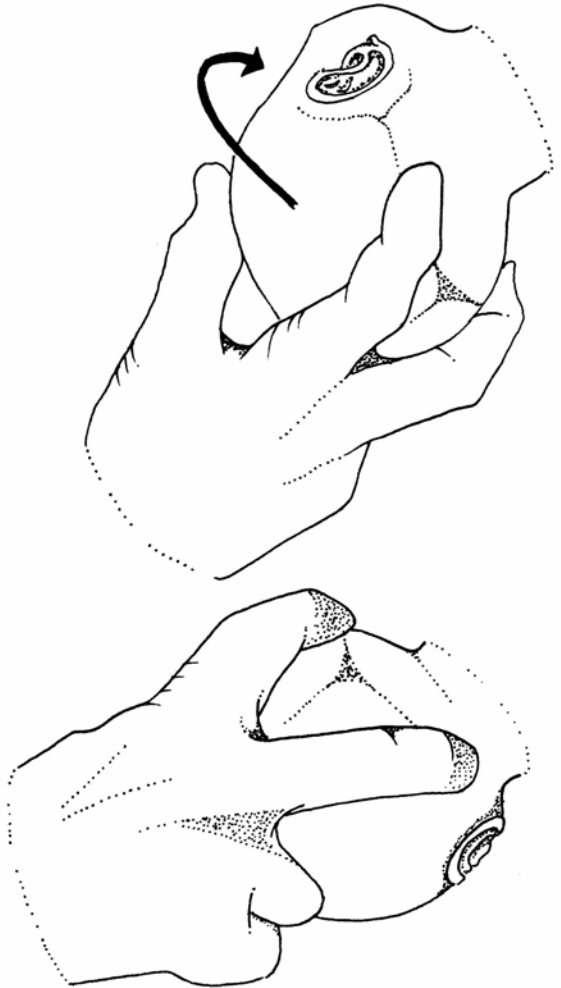

Figure 24.3 Finger rotation of occiput posterior to occiput anterior position

- Manual rotation.** The operator's four fingers are placed behind the posterior parietal bone with the palm up and the thumb over the anterior parietal bone. The right hand is used for the right OP position, and the left hand is used for the left OP position.

The head is grasped with the tips of the fingers and thumb. During a contraction, the patient is encouraged to push and the operator attempts to flex and rotate the fetal head anteriorly. Occasional mild upward pressure may help to slightly displace the head and facilitate rotation (see Figure 24.4).

If rapid delivery is indicated, failed manual rotation may be followed by vacuum delivery from the OP position. Manual rotation performed prior to instrumental birth is associated with little or no increase in risk to the pregnant woman or to the fetus. Ventouse or forceps delivery should never be attempted above 0 station or if the head is more than 1/5 above the symphysis pubis.

Figure 24.4 Manual rotation of occiput posterior to occiput anterior

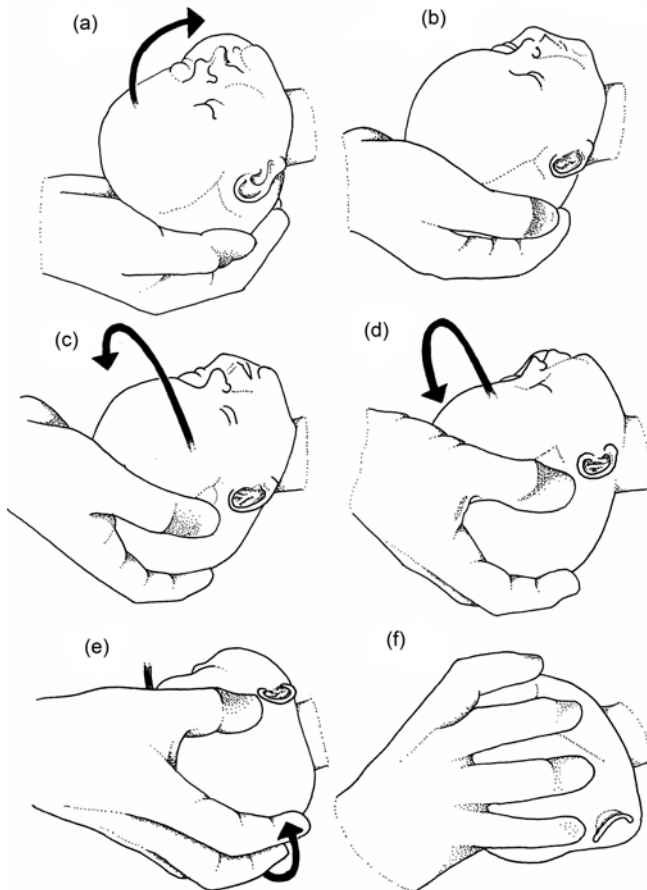

Section 24: Occipito posterior position

Mal-presentations

Delivery of a brow presentation (see Table 24.1)

In brow presentation, engagement is usually impossible, and arrested labour is common. Spontaneous conversion to either vertex presentation or face presentation can rarely occur, particularly when the fetus is small or when there is fetal death with maceration. It is unusual for spontaneous conversion to occur with an average-sized live fetus once the membranes have ruptured.

If the fetus is alive, deliver by Caesarean section if this can safely be undertaken.

If the fetus is dead and:

- the cervix is not fully dilated, deliver by Caesarean section
- the cervix is fully dilated, deliver after craniotomy.
-

If the operator is not proficient in craniotomy, deliver by Caesarean section.

Only if the fetus is small or very low in the vagina, a brow presentation might be delivered by vacuum extraction, forceps delivery or symphysiotomy.

Delivery of a face presentation (see Table 24.1)

This is due to extension of the fetal neck, caused by either a fetal abnormality or progression from a deflexed occipito-posterior position in labour. Diagnosis is important, as a face presentation may be mistaken for breech presentation.

Diagnosis

Face presentation may be detected on ultrasound scan before labour, but the majority of cases are unpredictable because they arise in labour.

On abdominal examination, a large amount of head is palpable on the same side as the back, without a cephalic prominence on the same side as the limbs.

On vaginal examination, in early labour the presenting part is high. Landmarks are the mouth, jaws, nose, and malar and orbital ridges. The presence of bony gums (alveolar margins) distinguishes the mouth from the anus. The mouth and the zygoma ridges of the maxillae (upper jawbone) form the corners of a triangle, whereas the anus is on a straight line between the ischial tuberosities.

- Avoid damaging the eyes with trauma or use of antiseptics.
- Ventouse must not be used.
- In early labour, particularly with the occipito-posterior position and a multiparous patient, deflexion is common. In such cases, uterine contractions often cause increased flexion, and delivery will proceed as normal. However, if extension occurs, a brow presentation and finally the fully extended face will result. Most face presentations therefore only become obvious late in labour.
- Descent is usually followed by internal rotation with the chin passing anteriorly. If the chin is towards the pubis (mento-anterior), the baby can often be delivered normally, although an episiotomy is usually necessary. If the chin lies towards the back, delivery will not occur and a Caesarean section will be required.
- The widest biparietal diameter is 7 cm behind the advancing face, so even when the face is distending the vulva, the biparietal diameter has only just entered the pelvis. Descent is less advanced than vaginal examination suggests, even allowing for gross oedema. The head is always higher than you think.
- Abdominal examination is vital.
- The head is born by flexion, causing considerable perineal distension in the process and risking considerable perineal trauma, so consider an episiotomy. Anterior rotation having occurred, the neck comes to lie behind the symphysis pubis and the head is born by flexion. The shoulders and body are born in the usual way.

With satisfactory uterine action and the mento-anterior (MA) position, spontaneous delivery or easy 'lift-out' (forceps-only) assisted delivery will ensue in 60–90% of cases (see Figure 24.5)

Section 24: Face presentation

Figure 24.5 Mento-anterior position

If spontaneous delivery of an MA face does not occur, a 'lift-out' forceps delivery can be performed (see Section 41 on forceps delivery).

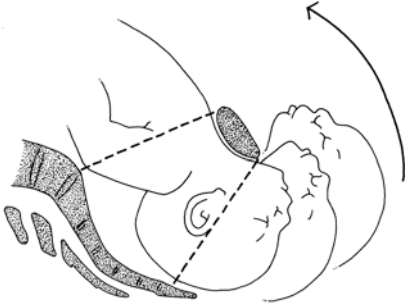

In mento-posterior (MP) positions (see Figure 24.6), the neck is too short to span the 12 cm of the

anterior aspect of the sacrum. In addition, the neck would have to be extended to pass under the symphysis, but it is already maximally extended. Delivery is impossible unless a very small fetus or one that is macerated allows the shoulders to enter the pelvis at the same time as the head. Even with MP positions, anterior rotation will occur in the second stage in 45–65% of cases, so a persistent MP position or mento-transverse arrest is encountered in only 10% of face presentations.

Persistent MP positions are usually delivered by Caesarean section (if this is possible and safe), in order to reduce fetal and maternal morbidity.

Figure 24.6 Mento-posterior position



Management of face presentations

- Make a diagnosis.
- Check for cord presentation or prolapse.
- Continuously monitor the fetal heart rate.
- Examine regularly to check that progress is adequate.
- Give oxytocin if progress is not satisfactory. (Caesarean section may be preferred to augmentation if facilities are available.)
- Do not use scalp electrodes or perform fetal blood sampling.
- If the position is mento-anterior, vaginal delivery should be possible.
- Perform an episiotomy.
- If the fetus is persistently presenting in an MP position, deliver by Caesarean section (if appropriate resources are available and it is safe to do so).

Delivery of compound presentations (see Table 24.1)

Here more than one part of the fetus is facing the cervix (e.g. an arm prolapsing alongside the presenting part). It is more common in prematurity.

Compound presentations, especially minor degrees involving just a hand can be managed expectantly in the early stages of labour, especially in the multiparous patient, and can sometimes

Section 24: Face presentation

be digitally encouraged back into the uterus. If they progress or persist and cause delay in the first or second stages of labour, then Caesarean section should be undertaken.

Transverse and oblique lies (see Table 24.1)

These are associated with prematurity, uterine fibroids and placenta praevia, and consequently are associated with high maternal and fetal morbidity. Always try to identify the underlying pathology, if any.

If the membranes are intact in early labour, it is worth attempting external cephalic version (see Textbook).

The presentation of shoulder, limb or cord in the presence of ruptured membranes means that Caesarean section is the only option for delivering a viable infant. If the fetus is dead, unless it is very small and macerated, it is safer to perform a destructive procedure if an operator experienced in the procedure is available.

Practical points to remember

- Using ultrasound, try to identify the cause of the abnormal lie, if any.
- **Positively exclude placenta praevia with ultrasound before performing digital vaginal examinations. If there has been no vaginal bleeding, placenta praevia is still possible.**
- Caesarean section can be extremely difficult:
 - The lower segment will be poorly formed.
 - Fibroids, when present, can distort the anatomy and inhibit access.
 - Placenta praevia is associated with severe haemorrhage.
- A vertical uterine incision may sometimes be most appropriate for the above reasons.
- Keep the membranes intact while making and extending the uterine incision, as this aids manipulation of the fetus into a longitudinal plane for delivery.
- Delivery is usually best achieved by finding, grasping and bringing down a foot (recognisable by the heel) into the incision. If the foot is difficult to find, the back and buttocks should be identified and the legs followed until a foot is found.
- If delivery is still impossible, the uterine incision can be extended upwards in the midline, making an 'inverted T'. If an extended uterine incision has been used, it is essential to undertake an elective Caesarean section in subsequent pregnancies, because of the risk of uterine rupture during labour.

Breech delivery (Table 24.1)

External cephalic version (ECV) see Textbook

Trial of vaginal breech delivery

This is difficult where there is limited availability of safe surgery, or surgery without delay. A trial may not be appropriate if:

- the mother is very small and/or the baby is large
- there is evidence of fetal–pelvic disproportion – that is, an inadequate pelvis (using clinical judgement) and an estimated fetal weight exceeding 4000 grams
- evidence (on ultrasound) of hyper-extension of the fetal head.

If there has been a previous Caesarean section or other scar in the uterus, a repeat Caesarean section may be preferable, although this will depend on the availability of safe surgery. Moving the woman to a waiting home next to a unit that provides comprehensive emergency obstetric care from 37 weeks' gestation (if available) may be a good option.

Procedure

- The mother should confirm her informed choice of vaginal delivery.
- If the mother is in hospital, an obstetrician, anaesthetist and operating theatre should be ready.
- Careful fetal monitoring and documentation of the partograph should be undertaken.
- The bladder must be emptied either naturally or with an in–out catheter.
- If spontaneous rupture of the membranes occurs, do a vaginal examination to check for cord prolapse. Meconium is common and not a sign of fetal distress.
- Amniotomy may be used to accelerate labour, where indicated, and careful use of oxytocin may be used to correct poor uterine activity if the mother is having her first baby. However, oxytocin should only be used in a well-resourced hospital. It should not

Section 25: Breech presentation and delivery

be used for poor progress due to poor uterine contractions in a mother who has previously given birth. Where available and safe, it is reasonable to perform a Caesarean section, rather than commencing oxytocin, even in primiparous women who are making inadequate spontaneous progress in labour.

- Caesarean section should be considered if there is poor progress or fetal distress.
- Ensure that a healthcare worker with adequate experience in delivering breech babies vaginally is present during the second stage.

The basic principle of delivering a breech is to avoid interfering.

- Active pushing should not be encouraged until the breech has descended to the pelvic floor and the cervix is fully dilated as confirmed by vaginal examination.
- Sitting the patient up at this stage may help to encourage descent of the breech. An episiotomy may well be required, but should not be performed until the anus is visible or until the baby's buttocks are distending the perineum.
- The breech will usually rotate spontaneously to lie with the sacrum anteriorly. Rarely it will try to turn posteriorly, and this must be prevented by holding the baby by the bony pelvis and rotating the baby to the back-anterior position as it descends with maternal effort.
- Extended legs are delivered by flexing the knee joint of the baby and then extending at the hips.
- The baby is supported only when the arms are delivered and the nape of the neck becomes visible. Avoid holding the baby's abdomen, as internal organs may be traumatised; the pelvis should be held gently to support the weight of the baby and prevent hyperextension of the fetal neck.

As the mother pushes, the anterior shoulder tip will become visible. A finger is run over the shoulder and down to the elbow to deliver the arm, if this does not occur spontaneously. The other shoulder will rotate anteriorly spontaneously to allow similar delivery of the other arm. If the arms are not delivering spontaneously despite the shoulders being visible, the Løvset manoeuvre should be used (see Figure 24.7). Traction on the baby combined with rotations as shown (multiple if necessary) will usually result in each arm dropping out of the cervix. Minimal assistance by the healthcare worker running a finger along the arm to disengage it may sometimes help.

Figure 24.7
Breech
delivery using
Løvset
method

An arm is extended alongside the head. Posterior shoulder is below sacral promontory and anterior shoulder above symphysis pubis

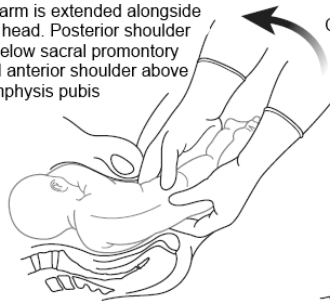

Clockwise

1) Fetus gently pulled down. MUST keep back uppermost to allow head to enter pelvis occipito-anterior.

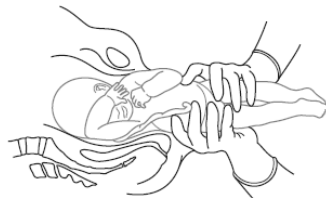

2) Rotation 180 degrees brings posterior shoulder anterior to lie under symphysis and arm descends

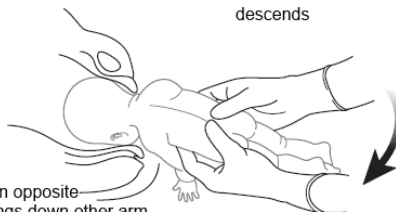

Anticlockwise

3) Rotation in opposite direction brings down other arm

Section 25: Breech presentation and delivery

- The baby lies supported as the head engages and the neck comes into view (see Figure 24.8).

Figure 24.8 Breech delivery: the baby should hang until the hairline at the back of the neck is seen.



- Delivery of the head may then be performed by the Mauriceau–Smellie–Veit manoeuvre (see Figure 24.9). The right hand is placed in the vagina, the fetus is supported on the right forearm, the middle finger of the hand is passed into the baby's mouth, and the first and third fingers are placed just below the bony ridges of the lower part of the orbits (the maxilla). The eyes must not be compressed. Pressure is applied to flex and deliver the head. The left hand is used to press upwards and posteriorly on the back of the fetal head to encourage flexion.
- Alternatively, forceps may be used to achieve the controlled delivery of the head. An assistant should hold the baby's feet to elevate the body above the horizontal to allow the operator access to apply forceps. The nape of the neck must be in view before the baby's body is lifted upwards, or damage to the fetal neck may be caused. It is also essential that the baby is not lifted too high, as this will damage the neck.

If the head fails to descend into the pelvis (i.e. the nape of the neck does not appear), first check that the cervix is fully dilated. If it is not, it will need to be incised. If the cervix is fully dilated, if possible forceps (ideally Piper's) may be applied to the fetal head to facilitate delivery. Firm suprapubic pressure may be applied in the midline to encourage the unengaged head to flex and facilitate delivery. If this is unsuccessful, a symphysiotomy should be considered. All of these manoeuvres are potentially dangerous for the mother. If the fetus dies, a destructive procedure should be undertaken.

Figure 24.9 Breech delivery: delivering the head by the Mauriceau–Smellie–Veit manoeuvre

To help to deliver the head safely, lay the body on your forearm. Put the index and middle fingers of your left hand on the bony ridges below the eyes. Place your right index finger on the occiput, flex the head, and deliver the head slowly and in a controlled way.

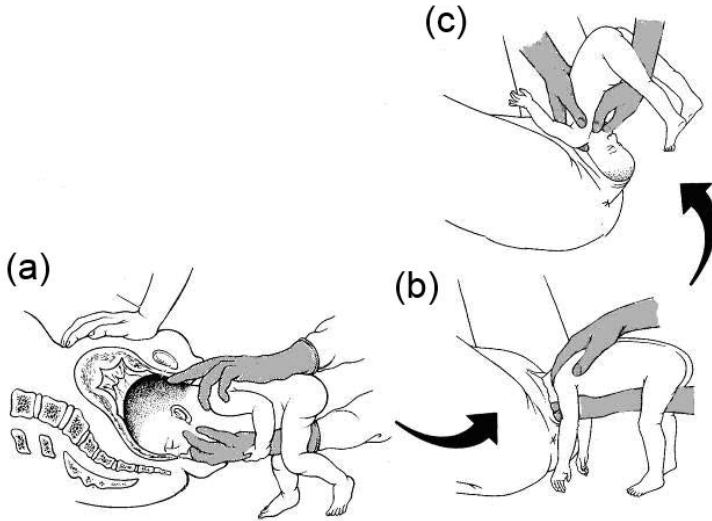

Elective Caesarean section for breech

This is advisable for the following:

- failed external cephalic version
- if vaginal birth is contraindicated, or the mother wishes
- double footling breech
- a very large fetus
- a small or malformed maternal pelvis
- a hyperextended or deflexed fetal head.

Before and at operation:

- Explain to the woman that she will have a scarred uterus, which may create problems in future pregnancies.
- Ensure that the presentation remains breech before anaesthetising the patient.
- Note that if the uterine incision is too small, there can be difficulty delivering the after-coming head.
- Remember to keep the fetal back upwards (anterior) during delivery.

Section 25: Preterm pre-labour rupture of membranes (PPROM) and/or preterm labour

PPROM is defined as spontaneous rupture of the membranes before the onset of labour and prior to 37 weeks' gestation. PPRM is associated with maternal mortality and morbidity with neonatal complications, which include cord prolapse, neonatal sepsis and respiratory failure, pulmonary hypoplasia and mal-presentations.

Preterm labour is defined as labour that begins before 37 weeks' gestation. It has increasingly serious implications for the neonate the earlier it occurs.

Preterm labour may occur without PPRM. However, ruptured membranes are a common early consequence of premature labour. Likewise PPRM can occur before labour, but the risk of progression to labour following PPRM is high (see below).

Management of PPRM and/or preterm labour

1. Avoid doing a digital vaginal examination unless active labour is under way and/or birth is imminent, as it increases the risk of infection.
A sterile speculum examination should be undertaken to look for amniotic fluid passing through the cervix or in the posterior fornix. A swab should be taken of the fluid and sent to the laboratory for microscopy and culture (if bacteriological facilities are available), looking especially for group B streptococcus.
2. Monitor vital signs (temperature, heart rate and blood pressure), vaginal discharge (check sanitary towels regularly; do not use tampons), uterine activity and possible tenderness, and fetal heart rate, and where possible perform an ultrasound examination to assess the amniotic fluid index, presentation, gestation and placental site.
3. Also check a full blood count, maternal blood group, malaria RDT +/- smear and a midstream specimen of urine (MSSU). If available a CRP along with the white blood cell count may help to indicate an underlying infection.
4. Although there is no evidence that bed rest is appropriate, if it is undertaken apply anti-embolism stockings (if available) and encourage leg exercises to prevent deep vein thrombosis.
5. Inform the paediatrician (if available).
6. Sexual intercourse should not occur after PPRM.
7. *When to consider antibiotics*
 - *Symptomatic ascending infection* in utero in the mother (fever, maternal and/or fetal tachycardia, foul-smelling vaginal discharge, uterine tenderness and signs of systemic illness) needs urgent treatment with IV antibiotics. If this is overlooked, the lives of both the mother and the baby will be in danger:
ampicillin 2 grams IV/IM, then 1 gram IV 6-hourly
plus gentamicin 80 mg IV/IM 8-hourly or 5 mg/kg body weight IV/IM once every 24 hours
plus metronidazole (vial containing 500 mg in 100 mL) 500 mg or 100 mL IV infusion every 8 hours. Do not give metronidazole IM.
Usually there will be uterine contractions, but whether or not they are present the baby must be delivered as soon as possible.
 - *Asymptomatic infection* (no fever and no systemic signs of illness) is a more common problem which may progress to a life-threatening infection at any time. It is therefore essential that all women who have or may have undergone rupture of membranes, are monitored regularly for the symptoms and signs of infection. These include: labour, generalised uterine pain, flushing and chills, body aches, fever (> 37.5°C), tachycardia, tachypnoea and fetal tachycardia.

If premature rupture of membranes is confirmed, the patient is stable, and a decision has been made to manage the patient expectantly (see below) then give prophylactic antibiotics as follows to help more safely to prolong the pregnancy:

Section 26: Preterm pre-labour rupture membranes and preterm labour

Erythromycin 250 mg TDS **plus** amoxicillin 500 mg TDS both orally and for 7 days.

All patients with confirmed premature labour should receive prophylactic antibiotics when in active labour as follows: IV ampicillin 2 grams IV/IM, then 1 gram IV 6-hourly. Discontinue antibiotics immediately after delivery if there are no signs of infection in the mother.

- *Maternal fever* (> 38°C) or other indication of infection in labour (e.g. offensive liquor) requires that the mother be treated with IV penicillin/ampicillin, **plus** metronidazole **plus** gentamicin as in 7. *Symptomatic ascending infection* above. If this is the case, the newborn infant should also be treated with IV antibiotics from birth without waiting for any signs of infection to appear (see Textbook).

8. Minimising the risk of surfactant deficiency in the newborn with antenatal steroids

High-dose corticosteroids can improve surfactant production in the newborn, but steroids must not be given if there is evidence of tuberculosis or HIV infection. A transient increase in blood glucose levels can occur with the use of steroids in diabetes. Even one dose of steroids can be effective in improving lung maturity in the newborn.

Give betamethasone, 12 mg IM, two doses 24 hours apart or dexamethasone, 6 mg IM, four doses 12 hours apart. Maximum benefit is achieved 24 hours following the second dose and for 1 week thereafter. Although it is not evidence based, where delivery is urgent, it is common practice to accelerate the course of steroids by giving the two 12 mg doses of either betamethasone or dexamethasone 12 hours apart.

A second course of dexamethasone or betamethasone can be given if more than 2 weeks have elapsed since the first course of treatment was given, and delivery has not occurred but premature labour has restarted. No more than two courses should be given.

9. Stopping premature labour

Premature labour is considered to be present if there are regular contractions at least every 10 minutes associated with cervical effacement and/or dilatation.

Labour can sometimes be delayed by treating the mother with tocolytic drugs. There is no evidence, however, that tocolysis alone is beneficial to the baby or mother. In fact their use is potentially dangerous, as delaying delivery may result in progression of the process which caused the premature labour in the first place, e.g. infection or abruption.

However, tocolysis may be useful to allow administration of antenatal corticosteroids (as above), thereby protecting the baby from lung surfactant deficiency. They may also allow transfer of the mother to a hospital where safer therapy can be provided for a preterm baby.

Tocolysis should not be given for more than 48 hours as this is the time taken for antenatal steroids to achieve their maximum therapeutic effects.

It is unsafe to try to stop labour if the membranes are ruptured.

Although tocolysis is not recommended after 34 weeks' gestation in well-resourced settings, it may possibly be helpful between 34 and 36 weeks' gestation in low-resource settings, as well as between 28 and 34 weeks.

If labour is well advanced and the cervix is more than 5 cm dilated, tocolysis will probably not be helpful.

Drugs used for tocolysis

If antenatal corticosteroids are not going to be given and there is no need to transfer the patient, then tocolytics are not indicated.

Nifedipine

Oral Nifedipine is the most appropriate drug. *Side effects* include facial flushing, headache, nausea, tachycardia, dizziness, a fall in blood pressure, heart failure and (rarely) increased liver enzymes. *Contraindications* are situations where delivery is desired, such as antepartum

Section 26: Preterm pre-labour rupture membranes and preterm labour

haemorrhage, severe pre-eclampsia, infection, fetal distress and all cases of PPROM in low-resource settings. Nifedipine should not be given if the mother has heart disease.

Before starting nifedipine, measure urea and electrolytes and liver function tests (where available).

Regular and frequent measurements of the mother's vital signs, as well as the fetal heart rate, should be undertaken. Closely observe for signs of heart failure. If the blood pressure falls, give a bolus of 250–500 mL of Ringer-lactate or Hartmann's solution.

Doses of nifedipine:

- Initial dose: 20 mg of oral nifedipine.
- Up to three further doses can be given at 30-minute intervals if uterine contractions persist.
- If this stops labour, and the blood pressure is stable, give a maintenance dose of 20 mg three times a day for up to a total of 48 hours. The maximum daily dose is 120 mg of nifedipine.

Terbutaline

This alternative can be given in a dose of 250 micrograms subcutaneously every 6 hours.

10. How long should you wait before inducing labour when there is PPROM?

The decision on timing of delivery is difficult, and it depends on the stage of pregnancy, the availability of comprehensive emergency obstetric care, the quality of neonatal care available and the obstetric history and wishes of the patient.

If expectant management is undertaken women with PPROM should be resident in a healthcare facility where comprehensive emergency obstetric care is available. Induction of labour should be undertaken by 36 weeks as prolonging the pregnancy beyond this stage is of reduced benefit to the fetus.

In a resource poor setting it is reasonable to induce the pregnancy at a much earlier gestation, even if this will result in a neonatal death, in order to reduce maternal risk.

Patients should be monitored closely for any symptoms or signs of infection, and if any develop delivery should be achieved urgently (via induction or Caesarean section, whichever is indicated) regardless of gestation.

Suggested monitoring would include:

- Regular review for symptoms of infection, e.g. uterine pain, body aches, flushing, chills. The patient should be advised to report such symptoms as they occur.
- 2 to 4 times daily vital sign assessment – tachycardia (> 100 bpm), tachypnoea (> 20), and pyrexia (> 37.5° C) should raise suspicion of infection.
- At least twice weekly inflammatory marker assessment such as CRP (where available). Note: corticosteroid administration causes a transient increase in the maternal white blood cell count but does not affect CRP.

Section 26: Prolapsed umbilical cord

Management of cord prolapse

The longer the time between diagnosis of cord prolapse and delivery, the greater the risk of stillbirth and neonatal death. If the baby is dead, deliver in the safest way for the mother.

1 Assess fetal viability. If the baby is alive and of a viable gestation, and fetal heart sounds are heard with a Pinard's stethoscope or ideally a hand-held ultrasound fetal heart rate detector (e.g. Sonicaid), urgently relieve pressure on the cord by placing the woman in the knee-elbow or exaggerated Sims' position (Figure 26.1). This gives time for decision making. Care should be taken not to stimulate the cord by handling it. Exposure to low temperatures should also be prevented if possible.

2 Discontinue oxytocin if it is being used. You can buy time to allow the baby to be delivered by giving tocolysis with terbutaline 250 micrograms every 6 hours subcutaneously.

3 If the fetus is alive, prepare for either emergency vaginal delivery or emergency Caesarean section (if this can be undertaken safely).

4 If the cervix is fully dilated, and delivery is likely to be achievable within 5 minutes, encourage the patient to push and prepare to expedite the delivery by use of forceps or ventouse. The choice of instrument will depend on availability, operator experience and the position of the fetal head. If appropriate, forceps delivery is usually the most rapid method of achieving delivery, but must not be used by inexperienced staff. Rapid delivery is far more likely to be achieved in a multiparous woman.

5 If Caesarean section is safe and the only option (i.e. the cervix is not fully dilated, and the fetus is alive and viable), fill the bladder to raise the presenting part off the compressed cord for an extended period of time, so that the woman or girl can be transferred to the operating theatre (Figure 26.2). Insert 500 mL of sterile IV fluid into the bladder using an IV giving set attached to a Foley catheter. Inflate the balloon of the Foley catheter, clamp the catheter and attach drainage tubing and a urine bag. The full bladder may also decrease or inhibit uterine contractions. The bladder must be emptied by unclamping the catheter before opening the peritoneal cavity for Caesarean section. Mark the mother's abdomen to ensure that this is not forgotten. At skin incision, the bladder clamp must be released and the bladder emptied.

6 Ensure that venous access is in place with a reliable IV cannula.

7 Transfer the woman or girl to the operating theatre in the exaggerated Sims' position on a trolley.

Figure 26.1 Maternal positions for immediately relieving pressure on prolapsed cord

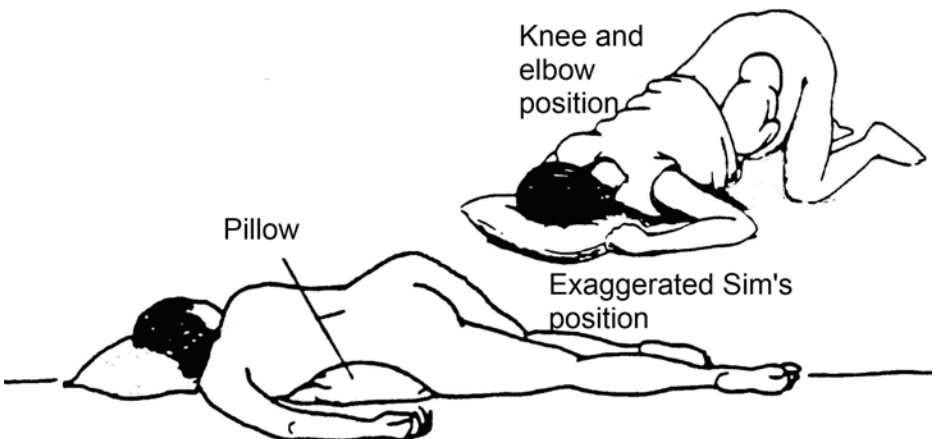

Section 26: Prolapsed umbilical cord

Figure 26.2 Treating prolapse of the cord by elevation of the fetal presenting part by inflating the bladder with sterile IV fluid

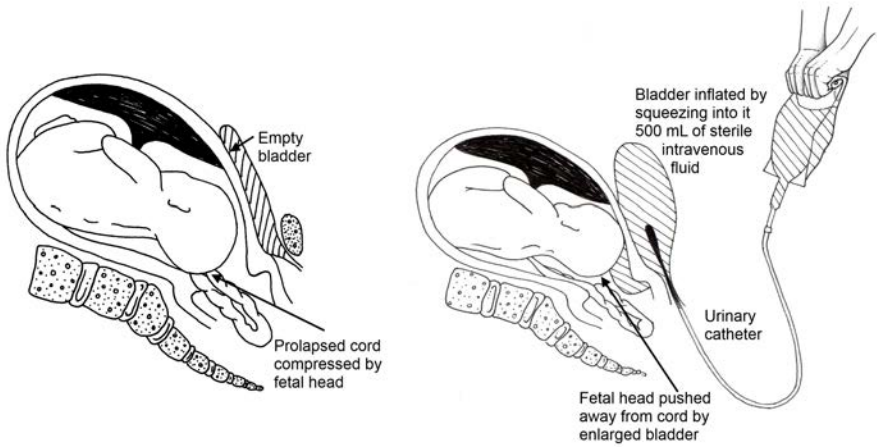

Section 26: Prolapsed umbilical cord

Figure 26.3 Pathway of care for prolapsed cord

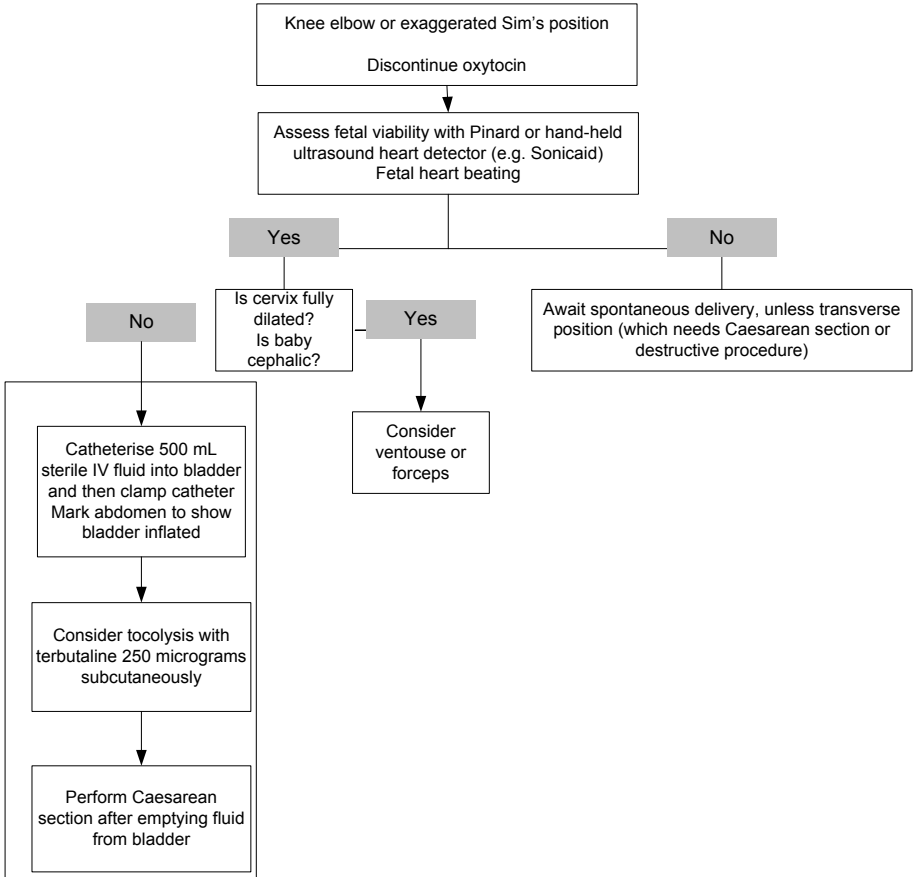

Section 27: Inverted uterus

Prevention

Prevent an inverted uterus by avoiding cord traction until the uterus is contracted and placental separation has occurred, and ensuring that the uterus is held back with one hand on the abdomen during cord traction.

Clinical signs

An inverted uterus most commonly presents as a pelvic mass, sometimes protruding from the vagina. If the inverted uterus does not protrude from the vagina, it may go undetected, resulting in a sub-acute or chronic inversion which is very dangerous and may even present as a sudden unexpected maternal death.

Symptoms and signs include severe lower abdominal pain in the third stage of labour, haemorrhage, shock out of proportion to blood loss, the uterus not being palpable on abdominal examination, and vaginal examination revealing a mass in the vagina.

Early recognition is vital, as shock is the most common complication. Shock out of proportion to blood loss may be due to increased vagal tone, which may also produce a bradycardia (< 60 beats/minute), worsening the shock and confusing its diagnosis. Inversion is associated with haemorrhage in over 90% of cases. Alternatively, concealed bleeding may produce tachycardia and other signs of shock.

Incomplete inversion presents more subtly with continuing postpartum haemorrhage despite a contracted uterus. The fundus of the uterus may feel dimpled.

Suspect a diagnosis of inverted uterus if there is:

- shock with little obvious bleeding
- continuing postpartum haemorrhage despite an apparently well-contracted uterus
- associated lower abdominal pain
- a dimpled uterine fundus
- a fundus that is not palpable abdominally.

Management

The uterus must be replaced as soon as inversion is recognised, as a matter of urgency, as this becomes more difficult over time. Call for help and try to push it back while ABC resuscitation is being undertaken.

Primary assessment and resuscitation

Call for senior help, including a surgeon and an anaesthetist. If shock is present, manage ABC as described below.

Manual replacement of the uterus

As soon as possible, and wearing sterile gloves, attempt manual replacement of the uterus by pushing the fundus back through the cervix (the longer the delay, the more difficult it will be to achieve resolution).

It is important that the part of the uterus that came out last (the part closest to the cervix) goes in first.

Figure 27.1 Bimanual replacement of inverted uterus

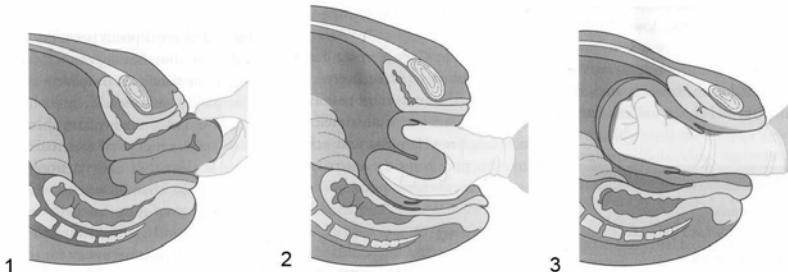

Do not attempt to separate the placenta until the inversion has been corrected.

Section 27: Inverted uterus

However, if the inversion has been present for some time (e.g. if it occurred at home), and replacement is not possible without placental removal, then be prepared for possible severe bleeding if this is undertaken.

Hydrostatic correction

- If manual replacement is unsuccessful, hydrostatic correction should be attempted.
- Place the woman in the steep Trendelenburg position (lower her head about 0.5 metres below the level of the perineum).
- Prepare a high-level sterile douche system with a large nozzle, long tubing (2 metres) and a reservoir (1–2 litres of sterile Ringer-lactate or Hartmann's solution at room temperature, not from a refrigerator).

— Note: This can also be done using Ringer-lactate or Hartmann's solution and an ordinary IV administration set.

- Identify the posterior fornix. This is easily done in partial inversion when the inverted uterus is still in the vagina. In other cases, the posterior fornix is recognised by the place where the ridged vagina becomes the smooth vagina.
- Place the nozzle of the douche in the posterior fornix.
- At the same time, with the other hand, hold the labia sealed over the nozzle and use the forearm to support the nozzle.
- Ask an assistant to start the douche at full pressure (raise the water reservoir to at least 2 metres). Ringer-lactate or Hartmann's solution will distend the posterior fornix of the vagina gradually so that it stretches. This causes the circumference of the orifice to increase, relieves cervical constriction, and results in correction of the inversion.
- If a Silc Cup ventouse is available, this can be used to occlude the vagina and give a seal. Two IV infusion sets are inserted into the narrow end while the wide end lies against the inverted uterus vaginally.
- Terbutaline, 250 micrograms subcutaneously, may help to stop any uterine contractions that prevent correction of the inversion.

Manual correction under general anaesthesia

If hydrostatic correction is not successful, try manual repositioning under general anaesthesia, using halothane. Halothane is recommended because it relaxes the uterus, but be aware of the risk of possible atonic uterus and haemorrhage.

ABC resuscitation if patient is shocked

Airway

- Use an opening manoeuvre if the airway is not open or is partially obstructed. Keep the airway open. If there is an improvement but the airway closes without active opening support, consider using an airway adjunct to support the airway.
- Suction only under direct vision and only if necessary.
- The airway may need to be secured by intubation using experienced senior help (if available).

Breathing

Provide a high concentration of oxygen through a face mask with a reservoir bag if there is adequate spontaneous respiration. Give 100% oxygen (mask with reservoir and a flow rate of at least 6 litres/minute) regardless of SaO₂.

For inadequate ventilation or depressed conscious level (P or U on the AVPU scale), respiration should be supported with oxygen via a bag-mask, and experienced senior help should be summoned (if available).

Circulation

Primary assessment suggesting shock:

- Fast, weak pulse (≥ 100 –110 beats/minute). Normal heart rates in a pregnant mother at rest are 60–90 beats/minute. Tachycardia is the first sign of shock.
- Bradycardia (< 60 beats/minute) may occur as a result of increased vagal tone due to the inversion.

Section 27: Inverted uterus

- Low-volume (weak) pulse.
- Pallor (especially of the inner eyelid, palms or around the mouth).
- Sweatiness or cold clammy skin.
- Prolonged capillary refill time (> 3 seconds).
- Rapid breathing (> 30 breaths/minute). Normal respiratory rates in a pregnant mother at rest are 15–20 breaths/ minute. Tachypnoea can be due to acidosis.
- Low blood pressure (systolic < 90–100 mmHg) is a very late sign. Healthy women and girls can maintain a normal or even high blood pressure while large volumes of blood are lost.
- Anxiety, reduced conscious level, confusion or unconsciousness.

If the woman or girl is shocked, obtain vascular access to give large volumes quickly. Insert two wide-bore IV cannulae (14- to 16G) and send blood for a full blood count, cross-matching (2 units) and clotting. If peripheral veins are difficult to access, the external jugular vein or long saphenous vein cut-down are good alternatives.

- Give an initial rapid bolus of 500 mL to 1 litre of Ringer- lactate or Hartmann's solution or blood if available. It is essential that the bolus is given as rapidly as possible. In the absence of syringe pumps, they should be pushed in manually using a 20- to 50-mL syringe (using a three- way tap and link to an IV giving set).
- Further 500- to 1000-mL boluses may be required in the first hour. Once more than 2 litres have been given IV, complications such as pulmonary or cerebral oedema may occur. If available, expert help, including CVP monitoring, is valuable.
- A blood pressure cuff can be used to speed up infusions in emergency situations. Wrap the cuff around the blood/ fluid bag and place it inside a non-compressible bag.
- Keep the patient warm but do not overheat them, as this will cause peripheral vasodilatation and reduce the blood supply to vital centres. Hypothermia will exacerbate poor peripheral perfusion, acidosis and coagulation abnormalities.
- Elevate the legs (raise the foot of the bed).
- Give O-negative or group-specific blood if there is not time for full cross-matching. Have O-negative blood ready in the ward at all times if possible.
- Consider giving atropine 100 micrograms IV, and repeat every 2 minutes up to a maximum of 400 micrograms IV if bradycardia is < 60 beats/minute.
- Consider using the non-pneumatic anti-shock garment (NASG).

Post-procedure care

Once the inversion is corrected, infuse IV oxytocin, 40 units in 500 mL of Ringer-lactate or Hartmann's solution, over 4 hours. If the uterus does not contract after oxytocin, give misoprostol 3 tablets each of 200 micrograms orally or 600 micrograms of powder sublingually if the patient is conscious, or 4 × 200 micrograms rectally if she is drowsy. The patient must be observed closely for haemorrhage.

Give a single dose of prophylactic antibiotics after correcting the inverted uterus. Use ampicillin 2 grams IV **plus** metronidazole 500 mg IV, and give appropriate analgesia.

Section 27: Inverted uterus

Figure 27.2 Pathway of care for inverted uterus. NASG, non-pneumatic anti-shock garment

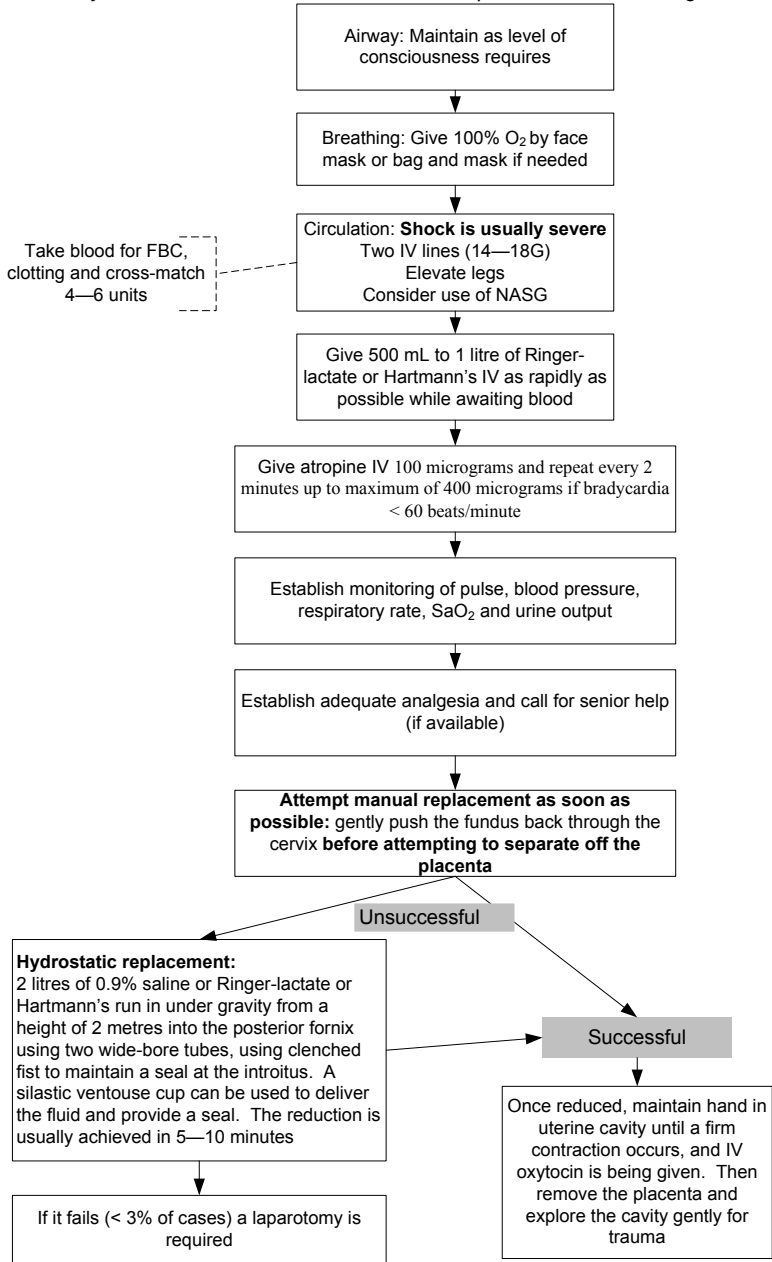

Section 28: Hyperemesis gravidarum

Investigations

- Ultrasound examination to exclude molar or multiple pregnancy
- Urine for ketones and to exclude urinary tract infection.
- Blood for haemoglobin, urea and electrolytes.
- Special investigations as indicated to exclude serious medical problems affecting the gastrointestinal, genitourinary, neurological, metabolic or endocrine and psychological systems.

Treatment of severe hyperemesis

1. Intravenous 0.9% saline, 1 litre given over 4 hours initially and then repeated as required, is the most effective treatment for severe hyperemesis with dehydration.
2. Small volumes (100–200 mL every 2–3 hours) of WHO oral rehydration salts (ORS) powder dissolved in 1 litre of water giving Na⁺ 75 mmol/litre, K⁺ 20 mmol/litre and glucose 75 mmol/litre can be given in addition to IV fluids until vomiting settles and if tolerated.
3. After IV fluids have been started, anti-emetic drugs may not be required, but if vomiting continues try prochlorperazine 12.5 mg IM and then orally 5 to 10 mg three times daily. Alternatives include cyclizine, 50 mg IM, IV or orally three times daily, domperidone 10 mg orally or 30–60 mg rectally four times a day, and metoclopramide 10 mg IM, IV or orally three times a day. If suppositories are available, rectal administration is ideal as it avoids the oral route in the nauseous and vomiting patient. It is often necessary to use a combination of anti-emetics. If this is done it is often best to combine drugs with different mechanisms of action (e.g. cyclizine plus metoclopramide) and to stagger their administration.
4. Supplements with thiamine should be given (IV if available) if there is evidence suggesting a severe deficiency may be present (Wernicke–Korsakoff syndrome). It should also be used prophylactically if the vomiting has been severe and/or protracted.
5. If available, urea and electrolytes should be monitored (ideally daily) in women with severe hyperemesis. Women are at particular risk of **hypokalaemia** if the vomiting is severe and protracted. In a vomiting patient who is not tolerating any diet, potassium replacement should be considered even where blood measurement is not available. The daily requirement of potassium is approximately 60 mmol in a 60 kg woman, and will be higher in the vomiting patient. Replacement should be undertaken with great care as too rapid replacement is dangerous.

A reasonable approach would be to add 20 mmol to 1 litre of 0.9% saline and to administer over 8 hours (42 dpm when using a standard giving set with a drop factor of 20). This provides a large margin of error as the infusion could be increased to >100 dpm before becoming hazardous. Ringer's lactate does contain 5 mmol of potassium/ litre and will provide some replacement if potassium is not available.

6. Hyperemesis is a risk factor for venous thrombo- embolism (DVT and PE). If a patient is admitted with severe hyperemesis she should be treated with anti-embolic stockings (if available).

Wernicke–Korsakoff syndrome

Symptoms of Wernicke's encephalopathy include the following:

- confusion
- loss of muscle coordination (ataxia)
- leg tremor
- vision changes
- abnormal eye movements (back-and-forth movements called nystagmus)
- double vision
- eyelid drooping.

Symptoms of Korsakoff syndrome include the following:

- inability to form new memories
- loss of memory, which can be severe

Section 28: Hyperemesis gravidarum

- making up stories (confabulation)
- seeing or hearing things that are not really there (hallucinations).

Treatment of severe hyperemesis where possible symptoms or signs of Wernicke–Korsakoff syndrome are present

Give an IV infusion of 10 mL of Pabrinex (Vials 1+2) in 100 mL of 0.9% saline over 1 hour (vials contain thiamine, ascorbic acid, nicotinamide, pyridoxine and riboflavin).

Subsequently, give oral thiamine 50 mg three times daily until vomiting has stopped.

Other management on discharge from hospital

Withhold iron tablets until vomiting has resolved, but ensure that they are taken subsequently, as iron-deficiency anaemia may have been an important consequence of the hyperemesis.

Try to help with any depression that is present.

Section 29: Heart failure during pregnancy

5 main causes of heart failure during pregnancy

1. severe anaemia
2. structural heart disease
3. circulatory overload (e.g. excessive IV fluids)
4. hypertension in severe pre-eclampsia
5. hypertrophic cardiomyopathy (HCM) and peripartum cardiomyopathy.

Heart failure can result from:

- left ventricular volume overload (aortic and mitral valve incompetence) or excessive pulmonary blood flow (e.g. congenital heart defects)
- left heart obstruction (aortic stenosis, mitral stenosis, hypertension)
- primary pump failure (severe anaemia, myocarditis, cardiomyopathy or arrhythmia)
- over-transfusion (a particular risk in hospital with IV blood or fluid infusions, especially in the anaemic mother).

Clinical signs

- respiratory distress (raised rate and some chest wall recession)
- tachycardia out of proportion to respiratory difficulty
- raised jugular venous pressure

Normal levels of jugular venous pressure (JVP) are 4–5 cm above the sternal angle. In heart failure the JVP can be raised so that the external jugular vein is filled up to or above the angle of the jaw

- gallop rhythm
- heart murmur
- enlarged liver
- basal lung crepitations

Treatment of severe decompensated heart failure

- Assess ABC.
- Sit the patient upright and ensure bed rest.
- Give a high concentration of oxygen via face mask with reservoir bag.
- If there are signs of shock (poor pulse volume or low blood pressure with extreme pallor and depressed conscious level), treat for cardiogenic shock with inotropes (if available).
- If there are signs of pulmonary oedema, give IV furosemide 40 mg (and repeat as required).
- Provided the patient is not hypotensive (systolic blood pressure > 90 mmHg) and has no serious obstructive valvular disease, give a glyceryl trinitrate tablet 500 micrograms sublingually and repeat up to a total of 3 tablets.
- Give IV morphine 3 mg over 5 minutes, and consider repeating after 15 minutes. Morphine is effective in reducing the afterload and, in addition, will reduce anxiety and pain both of which are likely to make heart failure worse.
- For patients with persisting heart failure load with digoxin IV, 250–500 micrograms over 10 minutes, then after 6 hours 125–250 micrograms over 10 minutes, then after a further 6 hours 125–250 micrograms over 10 minutes.
- Or give an oral digoxin loading dose (instead of IV) of 375–750 micrograms, then after 6 hours 187.5–375 micrograms, then after a further 6 hours 187.5–375 micrograms.
- Maintenance digoxin dose IV or oral:
 - 125–750 micrograms once daily.
 - Reduce the dose in renal impairment. Be alert for low K⁺ levels.
- Consider thromboprophylaxis. This treatment must take into account any bleeding risk and the timing of delivery.
- Check for severe anaemia (especially if the haemoglobin concentration is < 5.0 g/dL), for which partial exchange transfusion may be helpful. Partial exchange transfusion can

Section 29: Heart failure

be achieved with a cannula in a large vein in the antecubital fossa. Withdraw 25 mL of anaemic blood and infuse 50 mL of new blood over 5 minutes, and repeat up to 10 times. An alternative is careful transfusion of packed cells (hang the bag vertically for 15-30 minutes) to allow the red blood cells to separate from the plasma. Transfuse only the red blood cell component with 40 mg IV furosemide for each unit of 500 mL infused.

Management of heart failure during labour

- The mother must deliver sitting up.
- Give oxygen from a facemask throughout labour.
- Limit infusion of IV fluids to decrease the risk of circulatory overload, and maintain a strict fluid balance chart.
- Ensure adequate analgesia (IV morphine 3mg over 5 minutes and repeat after 15 minutes and then review (see Section 5).
- If an oxytocin IV infusion is required, use a higher concentration at a slower rate while maintaining a fluid balance chart (e.g. the concentration may be doubled if the number of drops per minute is decreased by half).

Increase the rate of oxytocin infusion until regular strong contractions are established, and then maintain infusion at that rate.

- Avoid sustained, bearing-down efforts during the second stage if possible.
- If it is necessary to decrease the woman's workload during delivery, assist delivery by vacuum extraction or forceps (episiotomy may be helpful).
- Ensure active management of the third stage of labour. Oxytocin given on delivery of the baby must be given very slowly IV (5 units diluted in 20 mL of 0.9% saline over 5–10 minutes) to avoid hypotension.
- Do not give ergometrine.
- Note: Heart failure is not an indication for Caesarean section.

Management of anaesthesia if Caesarean section is needed see Textbook.

Cardiac consequences of rheumatic heart disease and their effects on pregnancy see Textbook.

Section 30: Severe asthma

Emergency treatment of severe asthma

- Assess ABC and resuscitate as needed.
- Give a high concentration of oxygen via a facemask with reservoir bag or nasal cannula. Attach a pulse oximeter and maintain $\text{SaO}_2 > 94\%$.
- Sit the patient up.
- Give nebulised salbutamol 5 mg driven with oxygen half-hourly to 4-hourly via a nebuliser (or 10–20 puffs of a beta-2-agonist inhaler, such as salbutamol or terbutaline, giving one puff at a time through a spacer with a mouthpiece or face mask).
- Give oral prednisolone 30–60 mg, or if the patient is vomiting, IV/IM hydrocortisone 100 mg, followed by 100 mg 6-hourly. (Note: steroids will not show benefits for a number of hours.)

If the patient is not responding, or their condition is deteriorating:

- Nebulised salbutamol may be given continuously.
- In acute severe asthma, 2 g of magnesium sulphate IV in 50 mL of Ringer-lactate or Hartmann's solution over 10–15 minutes can produce significant bronchodilatation.
- As an alternative to magnesium sulphate, and if the patient is not already on oral theophylline or other methyl-xanthines, give a loading dose of IV aminophylline 250 mg over 15 minutes, monitoring the ECG for arrhythmias (if possible), followed by 1 mg/kg/hour by IV infusion.
- IV salbutamol 250 micrograms over 10 minutes is an alternative to magnesium sulphate or aminophylline, followed by IV infusion of 1–5 micrograms/kg/minute (but monitoring ECG and checking K^+ levels regularly is essential; extra potassium may be needed, and monitoring of plasma K^+ levels is essential if this drug is given IV).
- In severe cases in the absence of other measures, adrenaline can be effective. It should be given subcutaneously or IM (dose = 500 micrograms to 1 mg), but may be given IV in life-threatening asthma as follows.
 - Place 1 mg of adrenaline in 10 mL of 0.9% saline and give 1 mL of this solution. Wait for 1 minute and then keep on repeating 1 mL doses IV every minute until the patient improves or the whole 1 mg (10 mL) has been given. The risk of cardiac side effects (tachycardia, cardiac arrhythmias) is low if adrenaline is given in this way.
- In patients with poor respiratory effort, depressed conscious level and poor oxygenation despite maximum oxygen therapy:
 - Attempt to support ventilation with a bag-valve-mask.
 - Summon experienced support (an anaesthetist) if available, and consider intubation for mechanical ventilation with IV ketamine or halothane induction.
- Indications for intubation and positive pressure ventilation (if available)
These include the following:
 - increasing exhaustion
 - progressive deterioration in clinical condition (e.g. a silent chest)
 - oxygenation decreasing and/or oxygen requirement increasing
 - pCO_2 increasing (if measurable from arterial/capillary gas)
 - sudden deterioration
 - massive atelectasis
 - pneumothorax.

If the patient is responding and improving, continue inhaled salbutamol as often as indicated.

Other measures

- Reassure the patient, and avoid upsetting them by performing unnecessary invasive procedures.
- Give IV steroids to cover labour/delivery for prevention of Addisonian crisis in patients with a history of taking significant doses of oral steroids in the recent past, especially if long term.
- Restrict IV fluids to two-thirds of the normal requirements.

Section 30: Severe asthma

- Give antibiotics only if there are signs of infection (fever and other signs of pneumonia; chest X-ray may be helpful).
- When the patient has recovered, review their maintenance treatment and inhaler technique.

Figure 30.1 Pathway of care for severe asthma in pregnancy

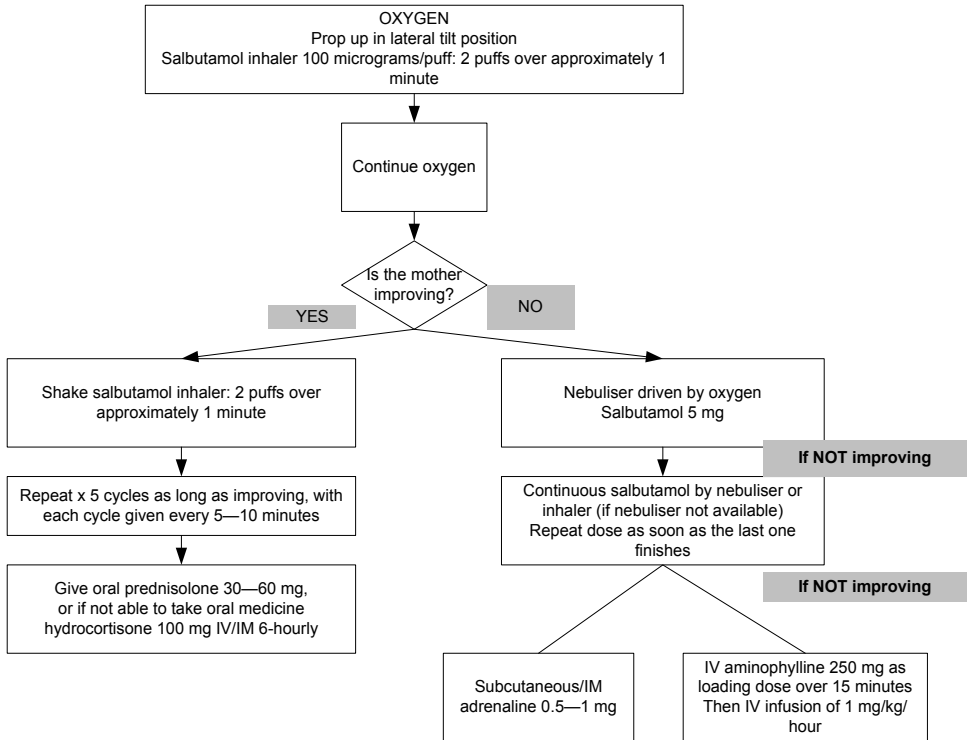

In acute severe asthma, 2 g of magnesium sulphate IV in 50 mL of 0.9% saline over 10–15 minutes can improve respiratory function

Section 31: Anaphylaxis

Section 31: Anaphylaxis

Anaphylaxis is an allergic reaction to ingested, inhaled or topical substances, which may present as one or more of stridor, shock or respiratory distress. Common causes include allergy to antibiotics, to radiographic contrast media, to blood transfusion, to insect bites and to certain foods, especially nuts. Anaphylaxis can occur with any drug.

This condition is potentially life-threatening, and may result in a change in conscious level, collapse, and respiratory or cardiac arrest.

Table 31.1 Symptoms and signs

	Mild
Symptoms	Burning sensation in mouth Itching of lips, mouth and throat Feeling of warmth Nausea Abdominal pain
Signs	Urticarial rash Angio-oedema Conjunctivitis
	Moderate
Symptoms	Coughing and/or wheezing Loose bowel movements Sweating Irritability
Signs	Bronchospasm Tachycardia Pallor
	Severe
Symptoms	Difficulty breathing Collapse Vomiting Uncontrolled defecation
Signs	Severe bronchospasm Laryngeal oedema Shock Respiratory arrest Cardiac arrest

Treatment

- Remove or stop the allergen if possible.

Section 31: Anaphylaxis

- Adrenaline 1 mg is given IM, unless there is intractable shock or cardiac arrest on presentation, in which case give adrenaline IV as follows:
 - Place 1 mg of adrenaline in 10 mL of 0.9% saline and give 0.5–1 mL of this solution. Wait for 1 minute and then keep on repeating 1 mL doses IV every minute until the patient improves or the whole 1 mg (10 mL) has been given.
- IV/IM hydrocortisone, 100–300 mg (if IV by slow injection) or oral prednisolone 40 mg stat.
- Nebulised adrenaline if there is stridor.
- Nebulised salbutamol 5 mg by oxygen driven nebulizer or adrenaline if there is wheezing.
- Antihistamine: chlorphenamine 10–20 mg by slow intravenous injection.
- Intubation and ventilation (if available) will be required for severe cases.

Figure 31.1 Pathway of care for anaphylaxis in pregnancy

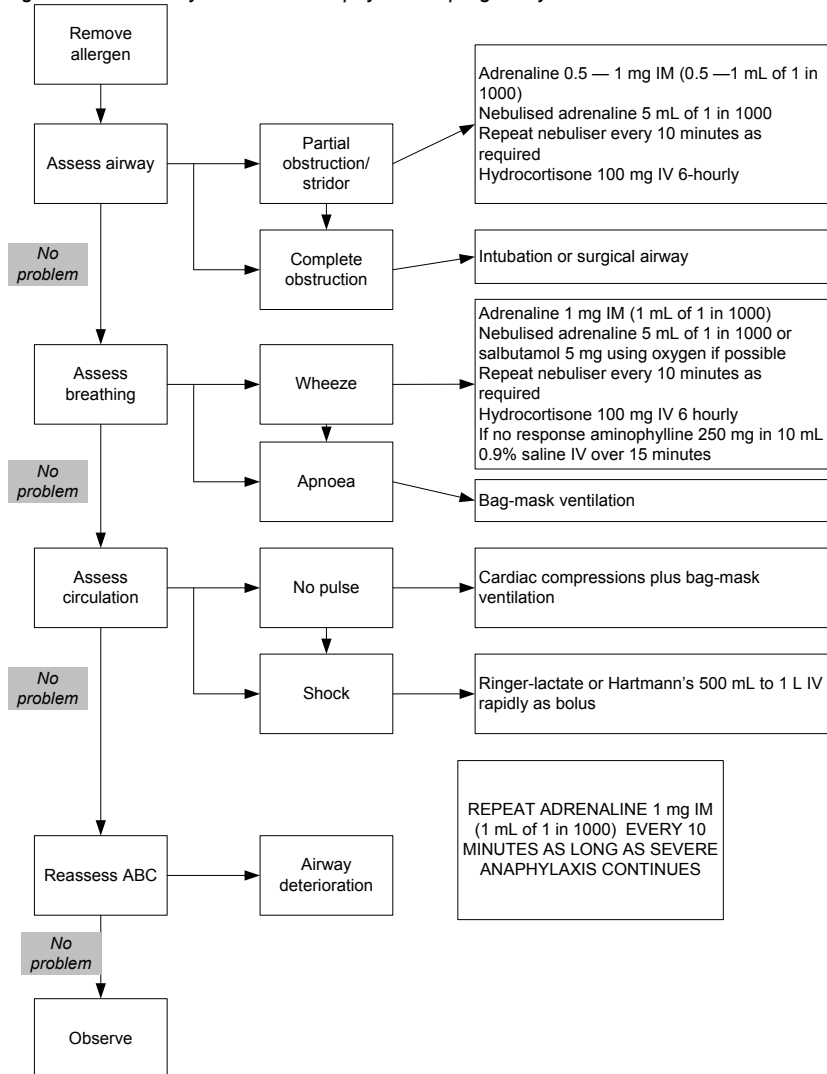

Section 32: Diabetes mellitus in pregnancy

Management of delivery in women with diabetes

For spontaneous labour, induction of labour and elective Caesarean section:

- 1 Measure glucose on admission and hourly during labour.
- 2 Site an IV line with 500 mL of 0.9% saline containing 10% dextrose and potassium chloride 10 mmol, and give at a rate of 60 mL/hour.

Avoid the routine use of insulin in labour in low resource settings because of lack of experience and lack of blood glucose stick tests. In mothers who were using insulin during pregnancy and those where blood glucose is > 7 mmol/ litre on two successive occasions one hour apart in labour, the insulin requirements shown in Table 2.7.D.2 below can be used.

TABLE 32.1 Insulin requirements

Blood glucose concentration (mmol/litre)	Hourly subcutaneous injections of insulin
<2.0	No insulin; dextrose only
2.0–4.0	1 unit
4.1–9.0	2 units
9.1–11.0	3 units
11.1–16.9	4 units

NOTE: for blood glucose, 1 mmol/litre = 18 mg/dL

- If the glucose level is > 17 mmol/litre, expert advice should be sought.
- Aim for a glucose level of 4–9 mmol/litre.
- Reduce insulin by half at delivery, and aim to resume the pre-pregnancy insulin dosage 24 hours after delivery. If the mother is breastfeeding, her insulin requirement may be lower.
- Women who have developed gestational diabetes usually have normal blood glucose levels soon after the delivery of the placenta. Their diabetic medication should be stopped postnatally, and their blood sugar levels should be monitored.
- Mothers who have had gestational diabetes should have a glucose tolerance test at 6 weeks postnatally. They are at risk of developing type 2 diabetes, and appropriate dietary and lifestyle advice should be provided. A fasting blood glucose test annually should also be recommended.

Diabetic ketoacidosis (DKA)

Diagnosis

History:

- polydipsia
- polyuria
- weight loss.

Clinical:

- acidotic respiration
- dehydration
- drowsiness
- abdominal pain and/or vomiting
- unexplained coma.

Biochemical:

- high blood glucose on finger-prick test
- ketones and glucose in urine.

Patients die from hypokalaemia and cerebral oedema.

Section 32: Diabetes and diabetic ketoacidosis

Patients who are 5% dehydrated or less and are not clinically unwell usually tolerate oral rehydration and subcutaneous insulin.

Patients who are more than 5% dehydrated, or who are vomiting or drowsy or clinically acidotic, need resuscitation and emergency care as follows.

Primary assessment and resuscitation

Airway

- If the airway is not open, use an airway-opening manoeuvre, and consider an airway adjunct such as an oropharyngeal airway or intubation (if available and subsequently supported).
- The nares and oropharynx may need gentle suctioning under direct observation.
- If the patient is unconscious and the airway is unprotected, the recovery position should be adopted to minimise the risk of aspiration of vomit.

Breathing

Give a high concentration of oxygen through a facemask with a reservoir, if the airway is adequate.

If breathing is inadequate, ventilate with oxygen via a bag-valve-mask-reservoir device, and ask for experienced senior help to intubate (if this is available and sustainable).

Circulation

- Gain IV access using a short wide-bore cannula (14- to 16G).
- External or internal jugular vein access is an option if peripheral access is impossible. Long saphenous vein cut-down may also be considered.
- Take blood for a full blood count, urea and electrolytes, blood culture, cross-matching, glucose stick test and laboratory blood glucose (if available).
- Give a 500-mL rapid IV bolus of 0.9% saline.
- An antibiotic such as cefotaxime 1 gram IV 6-hourly, or the locally available equivalent, is an appropriate antibiotic for those in whom an infection is likely to have precipitated the DKA. Although, of course, antibiotic therapy must be tailored to the specific cause.

Secondary assessment and emergency treatment

Observations

- Strict fluid balance and urine testing of every sample.
- Hourly capillary blood glucose measurements.
- Twice daily weights.
- Initially hourly or more frequent neurological observations.
- Report immediately to medical staff (even at night) symptoms of headache or any change in either conscious level or behaviour.
- Report any changes in the ECG trace, especially T-wave changes (monitoring for hypokalaemia).

Investigations

- When it is safe to do so, weigh the patient. If this is not possible, use recent clinic weight or an estimated weight.
- Blood glucose.
- Urea and electrolytes (if available).
- Bicarbonate or arterial blood gases (if available).
- Haematocrit and full blood count.
- Blood culture.
- Urine microscopy, culture and sensitivity; check for ketones.
- Monitor the ECG to observe T waves (if available):
 - hypokalaemia causes flat T waves
 - hyperkalaemia causes peaked T waves.

Assess degree of dehydration

No dehydration (< 3% weight loss)

There are no clinical signs with this degree of dehydration, although there will be thirst in the fully conscious patient. The woman or girl who is not fully conscious will not feel thirsty.

Some dehydration (3–9% weight loss)

Section 32: Diabetes and diabetic ketoacidosis

The following clinical signs are seen:

- increased thirst
- dry mucous membranes
- loss of skin turgor, tenting when pinched
- sunken eyes
- restless or irritable behaviour.

Severe dehydration ($\geq 10\%$ weight loss)

The following clinical signs are seen:

- more pronounced effects of the signs seen in moderate dehydration
- lack of urine output
- hypovolaemic shock, including:
 - o rapid and feeble pulse (radial pulse may be undetectable)
 - o low or undetectable blood pressure
 - o cool and poorly perfused extremities
 - o decreased capillary refill time (> 3 seconds): test this on the sternum of patients with light skins and on the thumbnail of those with dark skins
 - o peripheral cyanosis
- rapid deep breathing (from acidosis)
- altered level of consciousness or coma.

Fluid and electrolyte management

- Calculate the patient's fluid requirement. This is equal to maintenance plus deficit (see Figure 32.2).

Maintenance = 2400 mL per 24 hours

Deficit (in mL) = percentage dehydration \times body weight (kg) \times 10

(Only plan to correct up to an 8% deficit, as any more risks over-infusion).

- Ignore the volume of fluids used to resuscitate/treat shock.
- Give the total fluid requirement over 24 hours:
 - o Glucose > 12 mmol/litre: give 0.9% saline
 - o Glucose < 12 mmol/litre: give 0.9% saline containing 5% dextrose (by adding 100 mL of 50% glucose to 900 mL of 0.9% saline).
 - o Sodium 135–155 mmol/litre: correct by rehydration over 24 hours.
 - o Sodium > 155 mmol/litre: correct by rehydration over 48 hours using 0.9% saline.

Expect the sodium level to rise initially as the glucose level falls and water is removed from the circulation.

If the plasma sodium level initially falls (as well as the glucose level), this may precipitate cerebral oedema.

- Continue to give IV fluids until the patient is tolerating enteral fluids.

Insulin

In resource-limited settings, give subcutaneous doses of short-acting soluble insulin 6-hourly at 0.6 units/kg/dose (i.e. 0.1 units/kg/hour). Give half the dose if the blood sugar level is falling too fast.

Always have an IV glucose solution (10% or 50%) available to treat any hypoglycaemia that develops.

In well-resourced settings, make up a solution of 1 unit/mL of human soluble insulin (e.g. Actrapid) by adding 50 units of insulin to 50 mL of 0.9% saline in a syringe pump. Using a Y-connector, attach this to the IV fluids that are already running. Do not add insulin directly to the fluid bags.

The solution should then run at 1.1 units/kg/hour (0.1 mL/kg/hour). Never give an IV insulin infusion without a syringe driver. This is not safe. It is better to use a sliding scale of subcutaneous rapid-acting insulin as above.

- If the blood glucose level falls by more than 5 mmol/ litre/hour, reduce the infusion rate to 0.05 units/kg/hour.
- If the blood glucose level is less than 12 mmol/litre, and a dextrose-containing fluid has been started, consider reducing the insulin infusion rate.

Section 32: Diabetes and diabetic ketoacidosis

- Do not stop the insulin infusion while dextrose is being infused, as insulin is required to switch off ketone production.
- If the blood glucose level falls below 7 mmol/litre, consider adding extra glucose to the infusion.
- If the blood glucose level rises out of control, re-evaluate the patient for sepsis or another condition.
- Discontinue the insulin infusion 30 minutes after the first subcutaneous injection, to avoid rebound hyperglycaemia.

Potassium

In diabetic ketoacidosis there is always massive depletion of total body potassium, although initial plasma levels may be low, normal or even high. Levels in the blood will fall once insulin is started. Do not give potassium if any of the following are present:

- anuria
- peaked T waves on the ECG
- serum potassium level > 7.0 mmol/litre.

If biochemical assessment of the K⁺ is not possible, it should be assumed that K⁺ replacement is necessary as long as the urine output is adequate, and there are no peaked T-waves present on the ECG (where available).

- In resource-limited settings, hypokalaemia is most safely corrected orally or via nasogastric tube using ORS with or without additional oral potassium supplements (aim for a total of 100 mmol/day).
- Potassium rich foods may also be given, e.g. coconut milk and bananas.
- If oral supplementation is not possible or the patient is severely ill: start IV potassium supplements with 20 mmol/litre of IV fluid given after the start of initiating therapy with insulin and fluids as long as sufficient urine is being passed at > 30 mL/hour.
- Run the IV infusion (20 mmol in 1 litre over 4 to 8 hours (42 to 84 drops per minute (dpm) if using a standard IV giving set with a drop factor of 20). It should not be given at a rate exceeding 20 mmol in 2 hours (126 dpm) as this is dangerous. Given the difficulty in accurately monitoring transfusion rates without an electronic pump, a large margin of error should be used.
- Stop IV supplementation when the patient can take oral supplements.

Bicarbonate

- Administration of bicarbonate is rarely necessary.
- Continuing acidosis usually indicates insufficient fluid resuscitation.
- Consider the use of bicarbonate in patients who are profoundly acidotic (pH < 7.0 if measurable) and shocked. Its only purpose is to improve cardiac contractility in severe shock. The maximum volume of 8.4% sodium bicarbonate for half-correction of acidosis is calculated according to the following formula, and given over 60 minutes:
Volume (mL 8.4% NaHCO₃) = 1/3 × weight (kg) × base deficit (mmol/litre)
- Other investigations if indicated (e.g. if fever is present).

Additional emergency treatment

General

- After resuscitation with fluid boluses, calculate the fluid requirement (see below).
- Avoid excessive fluid replacement, as this is a risk factor for cerebral oedema.
- Do not give hypotonic IV solutions (e.g. 0.18% saline with 4% glucose, or 5% glucose): they are risk factors for cerebral oedema.
- Continue to give IV fluids until the patient is drinking.
- The kidneys will resolve the acidosis (if they are working) if the patient receives adequate fluid and insulin therapy.

Other management

Ensure adequate urine output

- Urinary catheterisation may be useful in patients with impaired consciousness.
- Document all fluid input and output.

Section 32: Diabetes and diabetic ketoacidosis

- Test all urine samples for glucose and ketones.
- If a massive diuresis continues, the fluid input may need to be increased.

Ileus

- Insert a nasogastric tube.
- Ensure by clinical assessment, and by abdominal X-ray if appropriate, that there is no other cause of the acute abdomen, including intestinal obstruction.

Gastric aspirate

- If large volumes of gastric aspirate occur, replace these volume for volume with 0.9% saline plus 5 mmol/litre potassium chloride (KCl).

Biochemistry

- Check urea and electrolytes, blood pH/bicarbonate (if available), and laboratory blood glucose 2 hours after the start of resuscitation, and then at least 4-hourly.
- Do not expect ketones to have disappeared completely before changing to subcutaneous insulin.

Assess conscious level

- Assess AVPU.
- Institute hourly neurological observations.
- If the patient is less than Alert on admission, or their conscious level deteriorates, record the Glasgow Coma Scale score.
- Consider instituting cerebral oedema management (if available).

Cerebral oedema

Look for irritability, slow pulse, high blood pressure and papilloedema (a late sign).

Infection

Cerebral oedema

Signs and symptoms include the following:

- headache
- confusion
- irritability
- reduced conscious level
- fits
- small pupils
- increasing blood pressure
- slowing pulse
- possible respiratory impairment.

Management

1. Exclude hypoglycaemia.
2. Give 20 grams of 20% mannitol over 15 minutes as soon as cerebral oedema is suspected. Repeat every 4–6 hours.
3. Restrict IV fluids to two-thirds maintenance, and replace the deficit over 72 hours rather than 24 hours.
4. Arrange for the patient to be intubated. Keep the PaCO₂ in the range 3.5–5.0 kPa (if this is possible and sustainable).
5. Keep the sodium (Na⁺) concentration higher than 135 mmol/litre.
6. Keep the head in the midline and 30-degrees elevated.

Fever

If there is a fever, treat it actively with environmental measures, or with paracetamol, if more than 38.0°C. DKA can cause a leucocytosis but not fever. If fever is present, look for and treat infection.

Section 32: Diabetes and diabetic ketoacidosis

Figure 32.2 Pathway of care for severe diabetic ketoacidosis in pregnancy ORS, oral rehydration solution

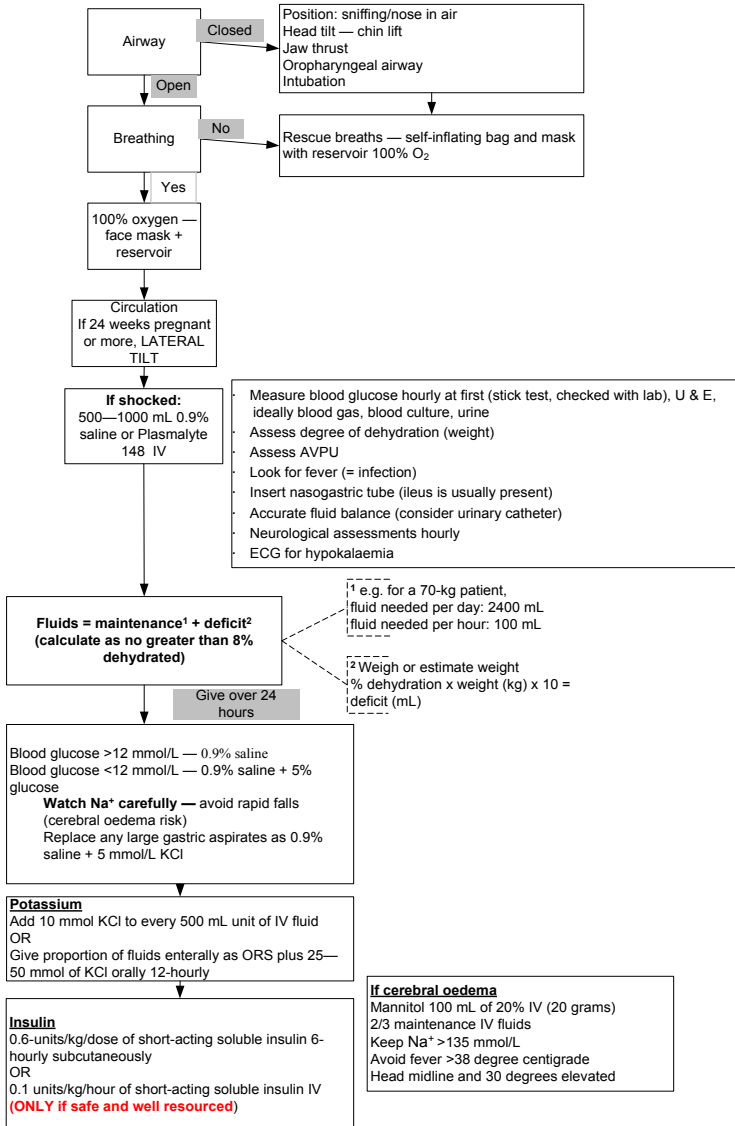

Section 33: Reduced consciousness and coma in pregnancy

Raised intracranial pressure (RICP)

In a patient with impaired conscious level or with a Glasgow Coma Scale score of < 9, who was previously well and is not post-ictal, the following signs indicate raised ICP:

Table 33.1 Clinical signs indicating raised intracranial pressure (RICP)

Signs suggesting raised ICP:	
Absolute signs = papilloedema and/or absence of pulsation of retinal vessels	
Abnormal oculo-cephalic reflexes Do not test patients with neck injuries in this way	(a) Rotation of the head to the left or right normally causes the eyes to move in the opposite direction; abnormal if there is no response or a random response (b) Flexure of neck usually causes eye gaze deviation upwards; abnormal if there is loss of this reflex
Abnormal posture May need to be elicited by a painful stimulus	(a) Decorticate: arms flexed, legs extended (b) Decerebrate: arms extended, legs extended (see Figure 5.16.A.3)
Abnormal pupillary responses	Unilateral or bilateral suggests raised ICP
Abnormal breathing patterns	Ranges from hyperventilation to Cheyne–Stokes breathing to apnoea
Cushing's triad	Slow pulse, raised blood pressure and abnormal pattern of breathing – a late sign of raised ICP

Figure 33.1 The recovery position

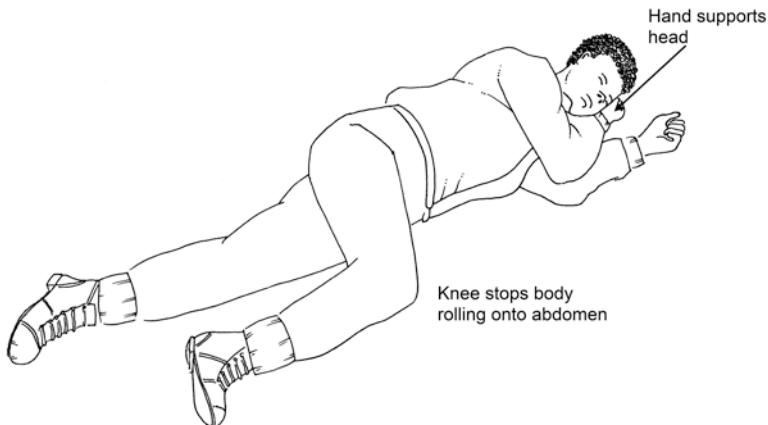

Section 33: Reduced consciousness and coma

Primary assessment and resuscitation ABCD

Call for help. Ideally an anaesthetist should be present to manage the airway and support breathing.

Airway

The patient with a reduced level of consciousness is more likely to have a compromised airway as the tongue falls into the back of the mouth. There is also a risk of aspiration

Look, listen and feel

Assess the airway, open it if closed and keep it open, either by assigning someone to continue airway-opening manoeuvres or by using adjuncts such as an oropharyngeal airway (see Section 9). Never use such an airway if the patient is conscious enough to have a gag reflex, as it may worsen airway obstruction and cause vomiting. Give oxygen at a rate of 15 litre/minute or as high a flow rate as is available, via a tight-fitting facemask with a reservoir bag. If an anaesthetist is present, intubation can be performed to protect the airway; otherwise adopt **the recovery position** (see Figure 33.1). Careful suction of the nose and/ or mouth may be helpful.

Breathing

If the airway is adequate, give high concentration O₂ via a face mask and reservoir bag and support breathing if required.

The patient will require support if:

- breathing is insufficient
- gag or cough reflex is absent
- GCS score is < 9, or AVPU score is P or U
- there is impending herniation due to raised ICP
- there is evidence of effects of inadequate breathing on other systems.

If breathing is absent or inadequate (gasping or agonal breaths only), provide assisted ventilation using a bag-valve-mask with a reservoir and oxygen.

Inadequate airway and breathing in coma can lead to a rise in arterial pCO₂ that can cause a dangerous rise in intracranial pressure.

Circulation

Inadequate perfusion of blood to the brain initially produces confusion and later causes coma. Measurement of the blood pressure in addition to other markers for shock is crucial in recognising hypovolaemia after haemorrhage, or unconsciousness after an eclamptic fit with hypertension. If the intracranial pressure is high, cerebral perfusion will be compromised if hypotension occurs. However, excessive fluid administration should be avoided.

- Establish IV access quickly.
- Take blood samples and send them to the lab for a full blood count, blood smear for malarial parasites, electrolytes, liver function tests, blood glucose and blood culture.

Neurological failure

Assess neurological failure as follows:

- Use the AVPU scale or Glasgow Coma Scale.
- Check blood glucose levels: If the blood sugar level is low or suspected to be low (< 2.5 mmol/litre or < 45 mg/dL), give 100 mL of 25% glucose IV over 15 minutes (dilute 50 mL of 50% glucose with 50 mL of Ringer-lactate or Hartmann's solution) and then give 10% dextrose in Ringer-lactate or Hartmann's solution over 4 hours (add 100 mL of 50% glucose to each 400 mL of Ringer-lactate or Hartmann's solution infused).
- Check the pupils for signs suggesting raised intracranial pressure (RICP) or opiate overdose.
- Check for neck stiffness which may suggest meningitis.
- Look for other signs of raised intracranial pressure, as outlined above

Section 33: Reduced consciousness and coma

Table 33.2 Glasgow Coma Scale (GCS)

Response	Score
<i>Eye opening 1.</i>	
Spontaneously	4
To verbal stimuli	3
To pain	2
No response to pain	1
<i>Best motor response 2.</i>	
Obeys verbal command	6
Localises to pain	5
Withdraws from pain	4
Abnormal flexion to pain (decorticate)	3
Abnormal extension to pain (decerebrate)	2
No response to pain	1
<i>Best verbal response 3.</i>	
Orientated and converses	5
Disorientated and converses	4
Inappropriate words	3
Incomprehensible sounds	2
No response to pain	1
Total 1. + 2. + 3.	

A GCS score of < 9 is likely to need airway protection by intubation if skills are available to undertake this safely.

Table 33.3 Pupillary changes

Pupil size and reactivity	Causes
Small reactive pupils	Metabolic disorders Medullary lesion
Pinpoint pupil	Metabolic disorders Narcotic/organophosphate ingestion
Fixed mid-sized pupils	Midbrain lesion
Fixed dilated pupils	Hypothermia Severe hypoxaemic/ischaemic brain injury Barbiturate ingestion (late sign) During and post seizure Anticholinergic drugs

Section 33: Reduced consciousness and coma

Unilateral dilated pupil	Rapidly expanding ipsilateral lesion Tentorial herniation Third cranial nerve lesion Epileptic seizures
--------------------------	--

Secondary assessment and emergency treatment

Secondary assessment occurs after stabilisation of ABCD. During secondary assessment, continue to monitor the patient, and if there is any change, reassess ABC and treat any residual problems.

Diagnostic pointers

As soon as possible during resuscitation, gain as much information about the history as possible:

- the possibility of eclampsia, which means that magnesium sulphate may be required
- recent trauma
- endemic area for infections such as malaria, sleeping sickness and encephalitis
- pre-existing neurological problem
- past history of epilepsy
- ingestion of poisons
- underlying chronic condition (renal, cardiac, diabetes).

Remember to treat the treatable components. The cause of coma may not be certain, so it is always important to address ABC. If the patient's condition is unstable or deteriorating, return to ABC.

Always consider the possibility of eclampsia and the need for magnesium sulphate.

If there is no other clear cause for the coma treat with antibiotics for presumed meningitis (usually a third-generation cephalosporin, or whatever is locally available and appropriate), and in endemic areas, also treat as for cerebral malaria (see Section 36).

Take the patient's temperature (core and peripheral).

- Fever may be associated with sepsis (but lack of fever does not exclude sepsis) or poisoning (ecstasy, cocaine or salicylates).
- Hypothermia is found in poisoning with ethanol or barbiturates.

Rash: purpura suggests meningococcal disease; bruises suggest trauma (consider domestic violence).

Evidence of poisoning, ingestion or drug use: smell, residue around nose/mouth, needle tracks.

Other issues in addition to ABC regarding the management of coma

The prognosis depends on the cause of coma and the state of the patient, in particular the level of consciousness on admission, and the initial response to appropriate interventions. Consider the following interventions:

- Assess and maintain electrolyte balance (avoid hyponatraemia; use Ringer-lactate or Hartmann's solution plus added 5% glucose, not 1/5 N dextrose saline. Add 50 mL of 50% glucose to each 450 mL of Ringer-lactate or Hartmann's solution infused). If possible keep the serum sodium level in the normal range (135–145 mmol/litre).
- Treat seizures if present, and give prophylactic anticonvulsants if the patient has repeated seizures.
- Insert a nasogastric tube to aspirate the stomach contents. Give activated charcoal if poisoning is likely (see Section 44).
- Regulate the body temperature, and avoid hyperthermia (temperatures above 37.5°C).
- Undertake appropriate medical management of RICP, if present:
 - Support ventilation (maintain a pCO₂ of 3.5–5.0 kPa, if measurable).
 - Give mannitol, 20 grams of 20% mannitol IV over 15 minutes, 2-hourly as required, provided that the serum osmolality is not greater than 325 mOsm/litre (if measurable).
 - Give dexamethasone (for oedema surrounding a space-occupying lesion) 10 mg initially IV, then 4 mg IV 6-hourly for 48 hours.
- Catheterisation is needed for bladder care and output

Section 33: Reduced consciousness and coma

Meningitis or encephalitis

There is a risk of coning and death if a diagnostic lumbar puncture is performed in a patient with significantly raised intracranial pressure.

Diagnosis of meningitis or encephalitis

Classic signs and symptoms include the following:

- headache
- vomiting
- neck stiffness
- opisthotonus
- photophobia
- rash
- altered consciousness.

Poisoning (see Section 44).

Malaria in pregnancy (see Section 36).

Eclamptic coma (see Section 16).

Figure 33.4 Pathway of care in coma. ICP, intracranial pressure.

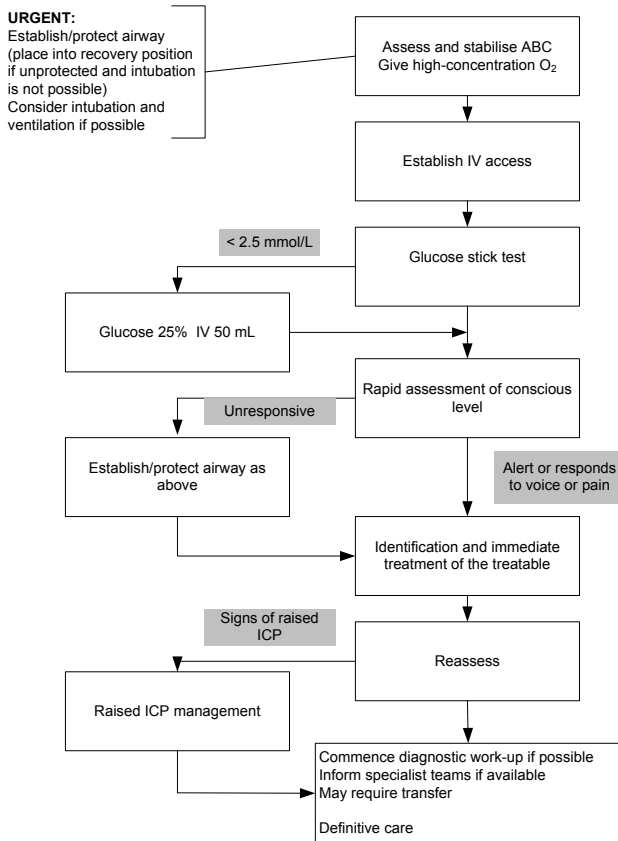

Section 34: Pneumonia in pregnancy

Clinical findings

A high fever is usually associated with pneumonia and bacterial tracheitis. In the absence of stridor and wheeze, breathing difficulties in association with a significant fever are likely to be due to pneumonia. Examination of the chest may show reduced air entry, bronchial breathing and crepitations. Pleuritic chest pain, neck stiffness and abdominal pain may be present if there is pleural inflammation. Pleural effusions and empyema are complications.

Always consider HIV infection and TB.

Emergency treatment of pneumonia

- Ensure the airway is open and clear
- Give oxygen through nasal cannula or mask depending on flow rate required to maintain saturation as below.
- Attach a pulse oximeter (if available) and maintain $\text{SaO}_2 > 94\%$, with nasal cannula at a flow rate usually up to 5 litres/minute or if necessary by face mask with higher flow rates.
- Give antibiotics for 7 days:
 - ampicillin 2 grams IV/IM 6-hourly **plus** gentamicin 80 mg IV/IM 8-hourly or 5 mg/kg IV/IM every 24 hours for most cases of community-acquired pneumonia
 - cefuroxime 500 mg IV/IM 8-hourly or flucloxacillin 500 mg IM or IV slowly every 6 hours for suspected or bacteriologically diagnosed *Staphylococcus aureus*
 - erythromycin 500 mg every 6 hours orally for *Chlamydia* or *Mycoplasma pneumoniae*
 - or whatever is available locally and appropriate.
- Sit the patient upright.
- Maintain hydration.
 - Extra fluid may be needed to compensate for fluid loss from fever.
 - Fluid restriction may be needed because of inappropriate ADH secretion, revealed by oliguria < 30 mL per hour or rising blood urea levels.
- Chest X-ray is indicated.
- Large pleural effusions/empyemas should be diagnosed where possible by ultrasound, and pleural drainage undertaken under ultrasound cover (do not place a chest drain into the heart, liver or an undiagnosed tumour or hydatid cyst) (see Section 42). *Remember that in advanced pregnancy the diaphragm is elevated.*

Tapping the chest for diagnostic tests in pleural effusions or empyema

Diagnostic procedure

- Consider giving the patient oral analgesia
- Wash your hands and put on sterile gloves.
- Clean the skin over the chest with an antiseptic solution (e.g. 70% alcohol).
- With the patient sitting up, elect a point in the mid-axillary line (at the side of the chest) just below the level of the nipple (4th intercostal space); see Section 42). Do not lie a pregnant patient supine to undertake a chest tap unless too ill to sit up in which case ensure lateral tilt after 20 weeks gestation to prevent vena-caval obstruction.
- Inject about 1 mL of 1% lignocaine into the skin and subcutaneous tissue at this point.
- Insert a needle or needle-over-catheter through the skin and pleura, and aspirate to confirm the presence of pleural fluid. Withdraw a sample for microscopy and other tests and place it in a container.
- If the fluid is clear (straw-coloured or brownish), pull out the needle or catheter after withdrawing enough fluid to relieve distress, and put a dressing over the puncture site. Consider a differential diagnosis of tuberculosis.
- If the fluid is thin pus or cloudy (like milk), leave the catheter in place so that you can draw out more pus several times a day. Make sure that you seal the end of the catheter so that no air can get in.
- If the fluid is thick pus which cannot pass easily through the needle or catheter, insert a chest drain as described in Section 42.

Section 34: Pneumonia

Effusions/empyemas adjacent to the heart on the left side may cause pericarditis and cardiac arrhythmias. (Listen regularly for a pericardial rub, and ideally monitor an ECG if available until the patient is stable.)

Section 35: Severe dehydration and gastroenteritis in pregnancy

The majority of patients can be treated with low-osmolality oral rehydration solution (ORS) (by mouth or by nasogastric tube). **In patients with coincidental severe malnutrition, it is safer to use ORS with a lower sodium content, such as ReSoMal.**

Classification of dehydration

No dehydration (< 3% weight loss)

There are no clinical signs with this degree of dehydration, although there will be thirst in the fully conscious patient. The woman who is not fully conscious will not feel thirsty.

Some dehydration (3–9% weight loss)

The following clinical signs are seen:

- increased thirst
- dry mucous membranes
- loss of skin turgor, tenting when pinched
- sunken eyes
- restless or irritable behaviour.

Severe dehydration (≥ 10% weight loss)

The following clinical signs are seen:

- more pronounced effects of the signs seen in moderate dehydration
- lack of urine output
- hypovolaemic shock, including:
 - o rapid and feeble pulse (radial pulse may be undetectable)
 - o low or undetectable blood pressure
 - o cool and poorly perfused extremities
 - o decreased capillary refill time (> 3 seconds): test this on the sternum of patients with light skins and on the thumbnail of those with dark skins
 - o peripheral cyanosis
- rapid deep breathing (from acidosis)
- altered level of consciousness or coma.

Section 35: Severe dehydration and gastroenteritis

Figure 35.1 Pathway of care for gastroenteritis with severe dehydration (10% or more)

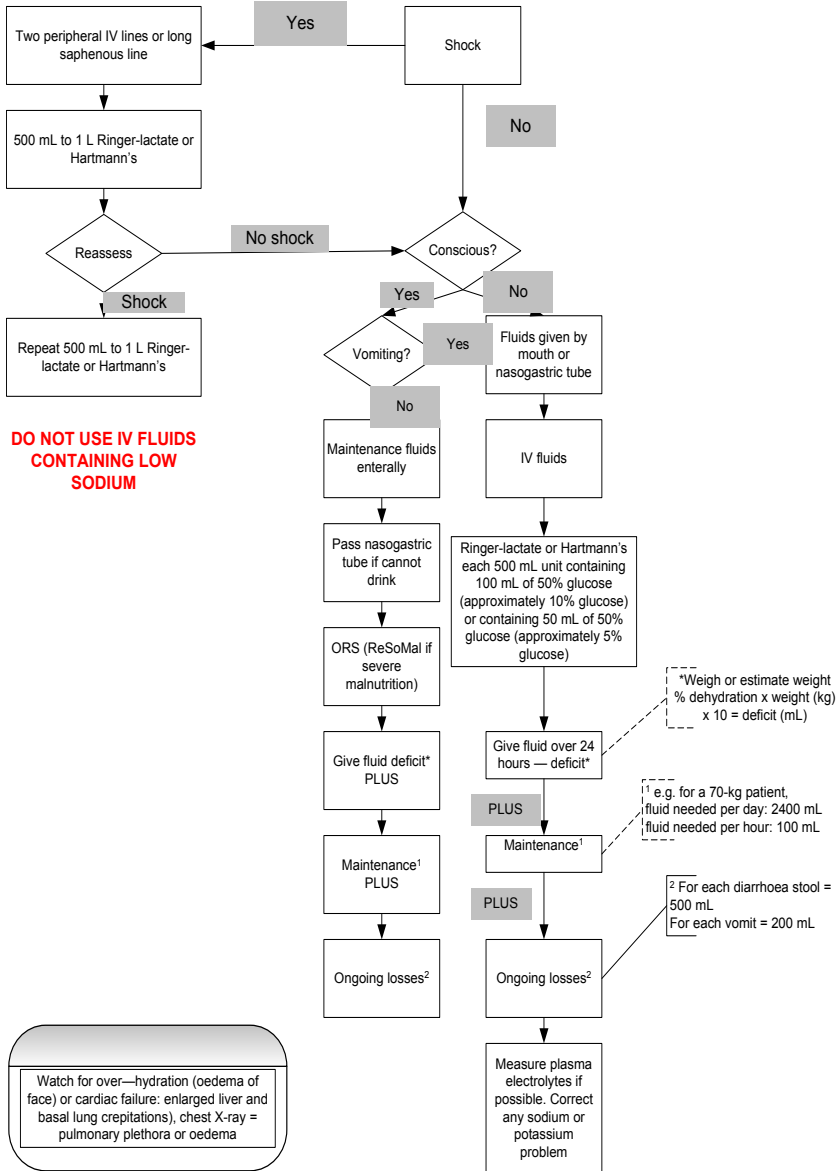

Section 35: Severe dehydration and gastroenteritis

Emergency treatment of severe dehydration

- Treat shock (see section 12) with an initial bolus of 1000 mL of Ringer- lactate or Hartmann's solution
 - Decide on the cause (e.g. acute gastroenteritis, diabetic ketoacidosis).
 - Classify the extent of dehydration (see above).
 - Calculate the fluid deficit (see below), add this to the maintenance and on-going losses and give over 24 hours.
 - The major danger in rehydration (once shock has been treated) is causing the plasma sodium level to fall too rapidly. This may increase the transfer of water into the brain and result in cerebral oedema.
 - Before the electrolyte results are known, or if such testing is not available, the safest fluid to give is Ringer-lactate or Hartmann's solution.
- If the serum sodium level is higher than 155 mmol/litre, aim to lower it slowly over 48 hours or longer.

Calculating fluid requirements

Deficit

If an accurate recent pre-illness weight is available, subtract the current weight to estimate lost fluid (1 kg = 1 litre of fluid).

For example, a patient who weighed 70 kg is seen with diarrhoea and a weight of 65 kg.

In this case the estimated fluid loss is $(70 - 65) \text{ kg} = 5 \text{ kg}$

= 5000 mL deficit (i.e. 7% dehydrated).

If no recent weight is available, or the weight value given is considered to be unreliable:

- Decide the degree of dehydration.
- Weigh the patient.
- Use the formula: $\text{percentage dehydration} \times \text{weight (kg)} \times 10 = \text{deficit (in mL)}$.

For example, a patient whose weight is estimated to be 70 kg is 8% dehydrated.

In this case the estimated fluid loss is $8 \times 70 \times 10 = 5600 \text{ mL}$ (233 mL/hour if replaced over 24 hours).

Maintenance

Estimated maintenance fluid requirements in pregnancy are 2400 mL/ day and 100 mL/hour.

On-going losses

- For each diarrhoeal stool: 500 mL of ORS after each stool.
- For each vomit: 200 mL of ORS after each vomit. Give small frequent volumes (e.g. 20 mL every minute) with a spoon or syringe or cup.

Add deficit to maintenance and on-going losses and aim to replace these over 24 hours.

For example, for a 70 kg patient who is 8% dehydrated, maintenance is 100 mL/hour, if there are no on-going losses. Total fluids needed per hour = 233 mL/hour (deficit) + 100 mL/hour (maintenance) = 333 mL/hour.

Severe acute gastroenteritis in pregnancy

Gastroenteritis is a common cause of dehydration and shock. Management starts with ABC, followed by assessment of the fluid deficit (extent of dehydration) and on-going losses of fluid.

Weigh the patient and keep an accurate fluid balance chart.

It is important to give fluids that:

- correct the deficit
- provide maintenance
- replace on-going losses.

Differential diagnosis

Look for an abdominal mass or abdominal distension.

Consider the following:

- HIV infections
- surgical conditions, such as acute appendicitis, peritonitis or bowel obstruction (if suspected, resuscitate and call for surgical opinion)

Section 35: Severe dehydration and gastroenteritis

- typhoid (high-grade fever, rash, hepato-splenomegaly and toxicity)
- cholera
- antibiotic-associated colitis
- (rarely) inflammatory bowel disease.

Treatment if not shocked

- Start low-osmolarity oral rehydration solution (ORS) with 1–2 litres over 2–4 hours.
- The carer should give small amounts of ORS (e.g. using a small cup) frequently.
- Gradually increase the amount as tolerated, using a tablespoon, cup or glass.
- After 12–24 hours, review progress with regard to rehydration and progress to the maintenance phase or continue rehydration.

Severe dehydration ($\geq 10\%$ fluid deficit with or without clinical signs of shock)

- If the patient is shocked, assess and manage ABC, give oxygen if available, and start IV fluids immediately (use two intravenous lines if possible: use long saphenous vein cut-down or the external jugular vein if venous access is difficult).
- Give a 500 mL or 1-litre bolus of Ringer-lactate or Hartmann's solution IV as rapidly as possible.
- Reassess pulse, perfusion (capillary refill time) and mental status, and repeat the bolus if these are still abnormal.
- Do not use low-sodium-containing IV fluids such as 0.18% saline with 4% glucose, which can be dangerous (they can cause hyponatraemia and cerebral oedema). Instead use Ringer-lactate or Hartmann's solution, ideally also containing 10% glucose (obtained by adding 100 mL of 50% glucose to each 500 mL).
- Hypokalaemia is a major complication which needs urgent attention. Ideally measure serum K⁺ levels frequently. Provided that the patient is passing urine, IV potassium can safely be given, it should be added to the IV fluids given subsequent to the boluses given to treat shock. Ideally and if tolerated, potassium should be corrected by giving low osmolarity ORS enterally as soon as possible.

If it is necessary to add potassium to IV fluids given to correct dehydration, particularly if diarrhea is continuing and if measured serum K⁺ is < 2.0 mmol/litre or there are ECG signs of hypokalaemia, namely ST depression, T-wave reduction and prominent U waves, and only if safe to do so, great care must be taken.

In acute depletion, an infusion at the rate of 0.1 to 1.2 mmol/kg/hour (6 to 12 mmol/hour for a woman weighing 60 kg) of IV potassium can be used and the serum K⁺ level checked after 3 hours. The potassium for injection must be diluted before use and thoroughly mixed before being given. The maximum concentration of potassium that can be given through a peripheral vein is 40 mmol/litre. **The maximum infusion rate of potassium is 0.5 mmol/kg/hour.** Remember that Ringer-lactate or Hartmann's solution both already contain 5 mmol/litre of potassium.

Note: The injectable form of KCl usually contains 1.5 grams (i.e. 20 mmol of potassium in 10 mL), and can be given orally. The daily potassium requirement is 1–2.5 mmol/kg (60–150 mmol for a patient weighing 60Kg).

When shock has resolved, and the patient's level of consciousness has returned to normal, the remaining estimated deficit must be taken by mouth or by gastric tube, especially if severe malnutrition and/or anaemia is present (giving large fluid volumes IV can precipitate heart failure).

Assess the patient's hydration status frequently.

Oral fluids

Recommendations for oral replacement therapy in gastro- enteritis are as follows:

Section 35: Severe dehydration and gastroenteritis

- Give low-osmolarity ORS (containing 75 mmol/litre of sodium) or, if the latter is unavailable, ORS containing 90 mmol/litre of sodium with an additional source of low-sodium fluid (e.g. water).
- The amount given should be in the range 300–500 mL/ hour.
- Giving high-osmolarity fluids may contribute to hypernatraemia, whereas giving water alone, or low-salt drinks, may cause hyponatraemia.
- Oral glucose within ORS enhances electrolyte and water uptake in the gut.
- 'Home-made' ORS can be prepared by adding a pinch of salt (1 mL) and a handful of sugar (5 mL) to a glass of clean potable water (250 mL).

Intravenous fluids

- Even in patients who are drinking poorly, try to give enteral fluids by mouth or by gastric tube until the IV infusion is running.
- Use Ringer-lactate or Hartmann's solution, which contains Na⁺ 131 mmol/litre, K⁺ 5 mmol/litre, HCO₃⁻ 29 mmol/litre and Ca²⁺ 2 mmol/litre.
- Ringer-Lactate or Hartmann's solution has no glucose to prevent hypoglycaemia. This can be corrected by adding 100 mL of 50% glucose to 500 mL of Ringer-lactate or Hartmann's, giving approximately a 10% glucose solution (adding 50 mL to 450 mL of Ringer-lactate or Hartmann's gives a 5% solution).
- Ringer-lactate or Hartmann's solution with 5% dextrose added has the advantage of providing glucose to help to prevent hypoglycaemia.
- See above regarding potassium supplementation.
- It is dangerous to use plain 5% glucose solutions, or 0.18% saline plus 4% glucose. They do not contain adequate electrolytes, do not correct the acidosis or hypovolaemia, and can cause dangerous hyponatraemia.
- All patients should start to receive some ORS (at the rate of about 300 mL/hour) when they can drink without difficulty, which is usually within 1–2 hours. This provides additional base and potassium, which may not be adequately supplied by the IV fluid. Alternatively, give as soon as possible by gastric tube.

Over-hydration

Signs of over-hydration include the following:

- oedematous eyelids and generalised oedema, particularly ankle, facial and sacral oedema
- cardiac failure, especially in severe malnutrition or protein-losing enteropathy.
- o respiratory distress (raised rate and some chest wall recession)
- o tachycardia out of proportion to respiratory difficulty
- o raised jugular venous pressure
- o gallop rhythm/murmur
- o enlarged liver
- o basal lung crepitations.

A chest X-ray may be helpful for showing pulmonary plethora or oedema.

Management of over-hydration

- Stop giving ORS, but give plain water and food.
- Do not give a diuretic unless the patient is in cardiac failure.

When the oedema has resolved, resume giving ORS.

Reassess the following:

- ABC
- circulatory and hydration status
- plasma electrolytes if possible
- urine output and urine electrolytes
- give fluid according to plan; do not forget ongoing losses
- reassess regularly (including biochemistry if possible)
- do not forget glucose.

Section 36: Severe malaria

Symptoms and signs

1. impaired consciousness (including coma)
2. prostration, i.e. generalised weakness so that the patient is unable to sit, stand or walk without assistance
3. multiple convulsions: more than two episodes within 24 hours
4. deep breathing and respiratory distress (acidotic breathing)
5. acute pulmonary oedema and acute respiratory distress syndrome
6. circulatory collapse or shock, systolic blood pressure < 80 mmHg
7. acute kidney injury
8. clinical jaundice plus evidence of other vital organ dysfunction
9. abnormal bleeding.

Immediate measures (in hospital)

- Vital signs: temperature, pulse, blood pressure, and rate and depth of respiration.
- State of hydration.
- Estimation or measurement of body weight.
- Level of consciousness (AVPU or Glasgow Coma Scale scores).

— The depth of coma may be assessed rapidly by observing the response to standard vocal or painful stimuli (rub your knuckles on the woman's sternum; if there is no response, apply firm pressure on the thumbnail bed).

- RDT and malaria smear (thick and thin film) for diagnosis and for continued monitoring of the progress of the disease. Do not wait for a malaria smear result before initiating treatment, as it can take up to an hour. If the RDT is positive, commence treatment immediately.
- Perform a lumbar puncture if the patient is unconscious, to eliminate meningitis (unless evidence of raised intracranial pressure when give antibiotics without prior diagnostic lumbar puncture).
- Measurement of glucose (finger prick test), haemoglobin, haematocrit and packed cell volume (PCV).
- Group and cross-match blood and search for a suitable donor if there are no blood banking facilities.

Severe malaria drug treatment in pregnancy

Treat malaria in pregnancy urgently and early.

Calculate the dose in mg/kg. If you cannot weigh the patient, an average pregnant woman weighs about 60 kg, a small woman weighs around 50 kg and a large woman in resource limited settings around 80 kg.

Where available, artesunate IV/IM or artemether IM are the drugs of choice in the second and third trimesters. Their use in the first trimester must balance their advantages over quinine (better tolerability and less hypoglycaemia) against the limited documentation of pregnancy outcomes. Artesunate may be given rectally.

IV/IM artesunate

Artesunate IV/IM: 2.4 mg/kg by direct IV injection (over 5 minutes) or IM injection at 0, 12 and 24 hours, then once daily until oral therapy is possible.

A solution for parenteral use should be prepared for either IV (10 mg/mL) or IM (20 mg/mL) use, following the manufacturer's instructions, using the sodium bicarbonate and saline solution supplied to dilute the concentrated artesunate.

For a small pregnant woman (estimated body weight 50 kg), each dose would be 12 mL IV (10 mg/mL) or 6 mL IM (20 mg/mL).

Artesunate IM should be administered in the antero- lateral thigh, drawing back before injection to ensure that the needle is not in a vein.

IM artemether

Artemether IM: loading dose is 3.2 mg/kg on day 0, followed by 1.6 mg/kg daily for at least two more doses; then continue until oral therapy is possible. A full course of oral therapy should be taken once IM therapy is discontinued.

An 80 mg/mL presentation is preferred to reduce the volume of the injection.

Section 36: Severe malaria

For a small pregnant woman (estimated body weight 50 kg) each dose would be 2 mL IM (80 mg/mL).

Artemether IM should be administered in the antero- lateral thigh, drawing back before injection to ensure that the needle is not in a vein.

Artemether is not well absorbed in shock, and in this situation an alternative treatment (parenteral or rectal artesunate, or IV quinine) should be chosen.

Rectal artesunate

- It is recommended that this should be available in all rural settings, including those with trained village healthcare workers.
- It can be given at 12-hourly intervals.
- The minimum dose is 10 mg/kg. Larger doses are not harmful, but are not more effective.
- It can also be given to vomiting patients, or those unable to tolerate oral drugs.
- Rectal artesunate must always be followed by a full course of ACT when the patient is able to take oral drugs.

At present the WHO only recommends rectal artesunate as a pre-referral treatment. Where referral is not possible, ensure that a full course of ACT is given as soon as the patient is able to take oral treatment.

Artesunate is available as a rectal capsule: Rectocaps (Mepha), 50 mg and 200 mg.

A WHO-approved rectal capsule is to be available soon, as 100 mg and 400 mg presentation.

The dose is 10 mg/kg, and therefore an average-sized mother needs 600 mg per dose. Give three 200 mg rectal suppositories at 0, 12, 24, 36, 48 and 60 hours.

Quinine dihydrochloride

Always give quinine with glucose.

Do not confuse doses of salt and base. Quinine is usually prescribed as the salt (10 mg of quinine dihydrochloride = 8.3 mg of base).

Loading dose

- Infuse quinine dihydrochloride 20 mg/kg body weight (usually 1.2 grams for the average 60 kg pregnant woman) in 500 mL of IV fluids (Ringer-lactate or Hartmann's solution plus 5% or 10% glucose) over 4 to 8 hours. Do not let it go in too quickly. Quinine is usually available in 2-mL ampoules of 150 mg/mL, where 1.2 g thus corresponds to 8 mL.
- Do not give quinine in 5% dextrose solutions without sodium, as there is a danger of hyponatraemia. Add 50 mL of 50% glucose to 500 mL of Ringer-lactate or Hartmann's solution to produce Ringer-lactate or Hartmann's plus 5% glucose solutions. Add 100 mL of 50% glucose to 500 mL of Ringer-lactate or Hartmann's solution to give 10% glucose solutions.
- Never give an IV bolus injection of quinine, as it is likely to cause cardiac arrest.
- Monitor blood glucose levels for hypoglycaemia every hour while the patient is receiving quinine IV.
- If it is definitely known that the mother has taken an adequate dose of quinine (1.2 grams) within the preceding 12 hours, do not give the loading dose. Proceed with the maintenance dose (see below).
- If the history of treatment is not known or is unclear, give the loading dose of quinine. Alternatively, omit the loading dose if the patient has received three or more doses of oral quinine in the last 48 hours, or mefloquine or halofantrine within the last 3 days.
- Wait 8 hours before giving the maintenance dose.

Maintenance dose

Infuse quinine dihydrochloride 10 mg/kg body weight (usually 600 mg for the average pregnant woman) in 500 mL of fluids (as above) IV over 4 hours. Repeat every 8 hours (i.e. quinine infusion for 4 hours, no quinine for 4 hours, quinine infusion for 4 hours, etc.) for 24 hours and then change to oral medication if the woman is conscious and able to swallow safely.

Section 36: Severe malaria

For follow-on oral treatment, give a 3-day course of ACT or 7 days of oral quinine. If the combination AS + MQ is used, wait 12 hours after the last dose of quinine before giving MQ. Do not use AS + MQ if the patient developed neurological signs during the acute phase. The dose of oral quinine dihydrochloride or quinine sulphate is 10 mg/kg body weight (usually 600 mg for the average size of pregnant woman) by mouth every 8 hours to complete 7 days of treatment. Ask the patient to swallow the tablets quickly with milk.

Quinine may cause haemolysis in patients with glucose-6-phosphate dehydrogenase (G6PD) deficiency, which may result in the passage of haemoglobin in the urine (this is called Blackwater fever).

Make sure that plenty of fluids are given so that the urine output is adequate. Keep a strict fluid balance chart. Monitor the volume of fluid that you give, and the urine output. Do not overload with fluid.

If the haemoglobin level falls below 6 g/dL, try to give blood, but observe closely for fluid overload. When the patient is improving, give iron and folate tablets.

Intramuscular quinine

If you cannot place an IV line, you can give quinine IM, at strength of not more than 60 mg/mL. Some ampoules are 60 mg/mL (usually 10-mL ampoules). Some ampoules are 300 mg/mL or 600 mg/mL. Dilute these in 0.9% saline or Ringer-lactate or Hartmann's solution to a concentration of 60 mg/mL (e.g. 600 mg of quinine in 10 mL of saline). If you do not dilute quinine, the mother may develop an injection abscess. Use the same dose as you would give IV. Give half the dose into each anterior thigh.

When giving quinine by IM injection, regularly draw back to ensure that the needle is not in a vein, as an IV injection of quinine is likely to cause cardiac arrest.

Follow-on treatment

When the patient has received at least three parenteral doses of artesunate or artemether, and is able to tolerate oral intake, give a full course (3 days) of ACT orally.

Additional measures where needed

- Insert a nasogastric tube to minimise the risk of aspiration pneumonia if the patient's level of consciousness is low. This can also be used to give food to prevent hypoglycaemia if the patient is unconscious for a long period and is unable to eat.
- Monitor for hypoglycaemia by laboratory or bedside testing if available (see below for more detailed advice).
- Insert an IV cannula.
 - Fluids should be given with caution and the need for them assessed on an individual basis after ascertaining the nutritional status and degree of dehydration present (see below for more details).
- In general, patients with metabolic acidosis who have not previously received parenteral fluids are dehydrated and should be managed accordingly (see below for more details).
- Give oxygen, especially if metabolic acidosis is suspected or shock is present.
- Treat severe anaemia with a safe blood transfusion if the patient is showing signs of decompensation.
- Give anticonvulsants (diazepam is preferred initially, then phenytoin if convulsions persist) if the patient is fitting, to prevent long-term neurological damage (see below for more details).

Convulsions are common before or after the onset of coma. They are significantly associated with morbidity and sequelae. They may present in a very subtle way. Important signs include intermittent nystagmus, salivation, minor twitching of a single digit or a corner of the mouth, and an irregular breathing pattern.

- Prophylactic anticonvulsants have been recommended in the past, but recent evidence suggests that phenobarbital is harmful.
- IV broad-spectrum antibiotics should be given routinely in an unconscious patient.

The patient will need intensive nursing care at least until they regain consciousness. They may urgently need glucose or a blood transfusion if hypoglycaemia or haemolysis is severe.

Section 36: Severe malaria

Fluid replacement

If the patient is unable to drink, maintain daily fluid requirements using the nasogastric (preferred) or IV (greater risk of fluid overload) route. Do not use 0.9% saline as it is an acid solution: use Ringer-lactate or Hartmann's solution. Measure urine output (a Foley catheter should be used in unconscious patients).

	Daily fluid requirement	Hourly fluid requirement
In pregnancy	50 mL/kg	2.0 mL/kg

IV fluids

A Ringer-lactate or Hartmann's solution plus glucose mix is commonly recommended. Use a 10% glucose mix with Ringer-lactate or Hartmann's solution if hypoglycaemia is identified. Monitor carefully for fluid overload, especially when the IV route is used. Switch to the oral route as soon as possible. Fluids given should be included in the daily fluid requirement totals to avoid over-hydration.

Antibiotics

All patients who are in shock or who remain severely ill following resuscitation should receive a presumptive treatment with broad-spectrum IV antibiotics. Unconscious patients should have a lumbar puncture to exclude meningitis. Where this is not possible a presumptive treatment with a suitable antibiotic should be given.

Continuing hospital care of pregnant women with severe malaria

This should include the following:

- Nurse in the lateral tilt position if the woman is more than 20 weeks' pregnant, to avoid inferior vena caval compression.
- If the patient is unconscious, nurse her in the recovery position, alternating sides frequently.
- Observe hourly pulse, blood pressure, respiratory rate and level of consciousness (using the AVPU scale).
- Frequently measure blood glucose levels (every hour if the patient has a reduced conscious level, especially when they are receiving quinine and/or where the level of consciousness does not improve).
- If the patient is conscious, regularly (4-hourly) determine blood glucose levels to exclude hypoglycaemia particularly if the patient is not eating well. This is especially important in pregnant women, particularly those receiving quinine therapy.
- A daily microscopic blood slide to determine the level of parasitaemia and to follow treatment efficacy.
- Regular haemoglobin measurement. The frequency will depend on the rate of red blood cell breakdown. This may be very rapid in cases of high parasite density.
- Blood transfusion where necessary with careful monitoring to prevent fluid overload. Packed cells should be used where possible. If overload is suspected, give a single dose of 20 mg IV.
- If the patient is unconscious or in shock, administer IV broad-spectrum antibiotics to manage septicaemia, pneumonia or meningitis, which are often associated with cerebral malaria.
- Oxygen is needed for patients in respiratory distress.
- Blood gases and urea and electrolytes should be measured where possible.
- Fluid balance charts: unconscious patients should be catheterised to measure urine output, facilitate correct fluid balance and detect possible renal failure.

Management of life-threatening complications of severe malaria

Severe anaemia (due to haemolysis)

Monitor haemoglobin levels daily.

Section 36: Severe malaria

Severe haemolytic anaemia: haemoglobin < 5 g/dL or haematocrit < 15%.

Severe anaemia may be the presenting feature in malaria. Patients with severe anaemia, especially pregnant women, should be tested for malaria.

- Establish safe transfusion as soon as possible.
- Transfuse with screened blood only if the patient is severely symptomatic. For patients with haemoglobin < 5 g/dL or haematocrit < 15%, recheck haemoglobin levels at least every 4 hours. Transfuse if haemoglobin levels start to fall or symptoms develop.
 - Packed cells are preferred for transfusion in pregnancy. Allow red blood cells to settle at the bottom of the bag, and stop the infusion when all of the cells have been used.
 - Perform microscopy following transfusion, and repeat or extend antimalarial treatment if parasitaemia is increasing.
- Transfusion rates may depend on the status of the patient. Exercise caution with malnourished patients.
- Suggested rates: two 500-mL units each over 4–6 hours giving IV 20 mg of furosemide with each 500 mL
- If the patient shows signs of fluid overload, give additional furosemide 20 mg IV, and repeat after 1–2 hours if indicated.

Give ferrous sulphate or ferrous fumarate 60 mg by mouth plus folic acid 5 mg by mouth once daily upon discharge.

Hypoglycaemia

This is defined as glucose levels of less than 2.5 mmol/litre (< 45 mg/dL).

Check for hypoglycaemia in patients who are unconscious, in shock or deteriorating, especially if they are malnourished, and in all patients receiving quinine. Often hypoglycaemia causes no symptoms until it results in coma and death. Watch for abnormal behaviour, sweating and sudden coma. Always give glucose with quinine. If the mother is drowsy, delirious or unconscious, do not assume that she has cerebral malaria; she could be hypoglycaemic.

Treat with an IV glucose infusion over 15 minutes.

- If you give 50% glucose it irritates the veins, so dilute 50 mL of 50% glucose with 50 mL of Ringer-lactate or Hartmann's solution to make a 25% solution and give 100 mL over 15 minutes.
- Then give 500 mL of 5% dextrose in Ringer-lactate or Hartmann's solution over 8 hours (see above for details of how to prepare this).

Retest 15 minutes after completion of infusion, and repeat the infusion if blood glucose levels remain low. Repeat until blood glucose levels recover, and then infuse with 5–10% glucose in Ringer-lactate or Hartmann's solution (according to hypoglycaemia risk) to prevent recurrence. Ensure regular feeding when oral intake can be sustained. Fluids used to treat hypoglycaemia must be included in the daily fluid requirements.

If you do not have IV glucose, give sugar water by mouth or by nasogastric tube. Dissolve 4 level teaspoons (20 grams) in a 200 mL cup of clean water.

Hypoglycaemia is a major cause of death in patients with severe malaria, especially those who are pregnant. Remember that quinine will potentiate hypoglycaemia. Patients should receive regular feeding, including by nasogastric tube, when they are unable to take oral foods.

Fluid balance problems

Maintain a strict fluid balance chart and monitor the amount of fluids administered and urine output to ensure that there is no fluid overload. Assess the patient's clinical status regularly.

Note: Pregnant women with severe malaria are prone to fluid overload.

Acute renal failure (ARF)

Section 36: Severe malaria

This is defined as an abrupt decline in the renal regulation of water, electrolytes and acid–base balance, and continues to be an important factor contributing to the morbidity and mortality of malaria patients.

Oliguria or anuria is often associated with jaundice, anaemia and bleeding disorders.

Note: Dehydration is a common cause of low urine output.

- The basic principles of management are avoidance of life-threatening complications, maintenance of fluid and electrolyte balance, and nutritional support.
- The patient must be catheterised so that urine output can be accurately measured.
- Acute renal failure is suspected when the hourly urine output is < 30 mL/hour (measured over 4 hours). Blood concentrations of urea and creatinine are usually raised (creatinine >90 micromol/L)
- Make sure that the patient is adequately hydrated, but avoid overload.
- If possible, monitor plasma electrolytes, especially serum potassium levels.

If urine output continues to be low despite adequate hydration, peripheral perfusion and normal blood pressure, give furosemide 40 mg IV.

If renal failure is established, restrict fluid to insensible loss (30 mL/hour) plus urine output. If possible, refer the mother to a tertiary care centre for management of renal failure. Consider peritoneal dialysis (if available).

Convulsions

If there are convulsions, consider whether the mother has eclampsia. Test the urine for protein and measure the blood pressure.

If the mother has eclampsia, treat this with **magnesium sulphate (Section 16)**. If she does not have eclampsia, prevent more convulsions with anticonvulsants, usually diazepam, paraldehyde or phenytoin.

Note: seizure activity in cerebral malaria needs to be looked for carefully, as it may just appear as a twitching of the thumb or mouth.

Diazepam

Give diazepam, 10 mg rectally or by slow IV injection over 2 minutes.

Do not exceed 10 mg per dose. Always have a bag- valve-mask of a suitable size available in case the mother stops breathing.

Paraldehyde 0.1 mL/kg of body weight may be given by deep IM injection (usually 6 mL total dose) or 0.4 mL/kg of body weight (usually 24 mL) intra-rectally using a sterile glass syringe (a disposable plastic syringe may be used provided that the injection is given immediately after the paraldehyde is drawn up, and the syringe is never reused).

Consider preventing subsequent convulsions with phenytoin (see below).

Phenytoin

Loading dose

Infuse phenytoin 1 gram (approximately 18 mg/kg body weight) in 50–100 mL of 0.9% saline over 30 minutes (the final concentration should not exceed 10 mg/mL).

Note: Only 0.9% saline can be used to infuse phenytoin. All other IV fluids will cause crystallisation of phenytoin. Flush the IV line with 0.9% saline before and after infusing phenytoin. Do not infuse phenytoin at a rate exceeding 50 mg/ minute, due to the risk of irregular heartbeat, hypotension and respiratory depression. Complete administration within 1 hour of preparation.

Maintenance dose

Give phenytoin 100 mg IV slowly over 2 minutes or by mouth every 8 hours beginning at least 12 hours after the loading dose.

Respiratory distress

Rapid laboured breathing: check for and treat secondary pneumonia (give antibiotics and oxygen) or anaemia (transfuse), or pulmonary oedema, which may occur with or without fluid overload.

Section 36: Severe malaria

Check the fluid balance (reduce IV fluids), supply oxygen, nurse the patient in a semi-sitting position, and do a trial of furosemide, 40 mg IV, repeating this after 1–2 hours if indicated. Slower laboured breathing (acidotic) (Kussmaul breathing): ensure appropriate fluid replacement (plus transfusion if indicated), and treat associated conditions and infections.

Metabolic acidosis

Deep breathing with a clear chest is a sensitive and specific sign for the presence of metabolic acidosis. It is the single most important determinant of survival, and can lead to respiratory distress syndrome. Metabolic (lactic) acidosis has been identified as an important cause of death in severe malaria.

Metabolic acidosis in severe malaria has been attributed to the combined effects of several factors that reduce oxygen delivery to tissues:

Management

- Maintain airway patency and oxygen delivery; intubate if the patient is unconscious, in severe shock, or otherwise unstable.
- Establish an IV line; replace an adequate intravascular fluid volume if the patient has tachycardia, hypotension or other signs of poor tissue perfusion, such as poor capillary refill time. IV normal (0.9%) saline can be harmful in severe malaria, when there is frequently acidosis. Normal saline is a strongly acidotic solution and can make the acidosis much worse. Therefore use Ringer-lactate or Hartmann's solution for IV fluid replacement or in shock.
- Monitor for cardiac arrhythmias.
- The use of sodium bicarbonate is controversial and generally should be avoided.

Pulmonary oedema is very dangerous. The mother may have it on admission, or it may develop after several days. Fast difficult breathing is the first sign. Frothy (bubbly) fluid may be coming from the mouth. Pulmonary oedema causes hypoxia, fits, coma and death. It can also be caused by too much fluid. Sometimes it is caused by malaria and too much IV fluid, so watch the jugular venous pressure regularly and ideally, if skilled, measure central venous pressure.

- Keep the patient upright; prop them up with pillows and lower the foot of the bed.
- Give high concentrations of oxygen using a facemask and reservoir.
- Give furosemide 40 mg IV. If there is no response (i.e. no increase in urine output), increase the dose progressively, every 4 hours, up to a maximum of 200 mg.
- If the woman might be receiving too much IV fluid, stop all drips.
- If the woman does not improve, withdraw 250 mL of blood into a transfusion bag. Give it back to her later.

Shock

Although severe malaria alone may cause shock (algid malaria), it is uncommon and bacterial sepsis often coexists, which must be treated.

Management includes initial assessment for severe anaemia, which can also be the cause of shock due to lack of oxygen-carrying capacity in severe anaemia. The management of severe anaemia, if this is responsible, is described above.

If the patient is not severely anaemic, and particularly if they are dehydrated, give rapid fluid replacement provided that there are no signs of pulmonary oedema:

- Ringer-lactate or Hartmann's solution IV, 500 mL over 30 minutes, then reassess. If there is no improvement in capillary refill or tachycardia, repeat the infusion once or twice more, as required.

Give IV broad-spectrum antibiotics to treat septicaemia and any associated infections.

Abnormal bleeding

- Transfuse with fresh blood.
- Give vitamin K 10 mg IV or orally.
- Avoid IM injections and non-steroidal anti-inflammatory drugs (NSAIDs).



Section 37: Acute appendicitis in pregnancy

Appendicitis should be suspected in any woman of child bearing age with abdominal pain. The diagnosis of appendicitis can be more difficult in pregnancy, due to the possibility of pregnancy-related conditions, including ectopic pregnancy, placental abruption, torsion of an ovarian cyst and pyelonephritis.

As pregnancy advances, the enlarging uterus displaces the appendix from its usual position, shifting the site of maximal tenderness towards the right upper quadrant. In the third trimester, it may consequently mimic cholecystitis. The site of an incision for appendicectomy should be over the point of maximum tenderness.

Clinical management

If appendicitis is suspected clinically, give a combination of antibiotics before surgery, and continue until the woman is post-operative and fever-free for 48 hours:

- ampicillin 2 grams IV every 6 hours
- **plus** gentamicin 80 mg IV/IM every 8 hours or 5 mg/kg body weight IV/IM once every 24 hours
- **plus** metronidazole 500 mg IV every 8 hours.

Morphine 10 mg IV over 5 minutes or IM may be administered as analgesia.

Immediate surgical exploration is required, regardless of the stage of gestation.

Appendectomy should be performed even if the appendix does not look infected.

Delaying diagnosis and treatment can result in rupture of the appendix, which may lead to generalised peritonitis. This has a high maternal mortality in pregnancy, as well as a significant risk of miscarriage or preterm labour.

If there are signs of **peritonitis** (fever, rebound tenderness and guarding), give antibiotics above as for peritonitis but continue until the infection has fully resolved (usually following surgery) and there has been no fever for 48 hours.

If appendicitis occurs in late pregnancy, the infection may be walled off by the gravid uterus. As the uterus rapidly decreases in size (involutates) after delivery, the infection may spill into the peritoneal cavity.

Section 38: Cystitis and acute pyelonephritis

Acute cystitis

Cystitis is a common complication of pregnancy, and is characterised by dysuria, frequency, urgency and, if severe, by haematuria. Severe cystitis can progress to pyelonephritis if not treated. The presence of loin pain and tenderness, along with fever, suggests a diagnosis of pyelonephritis.

Asymptomatic cystitis is more common in pregnancy, carries a risk of progression to pyelonephritis, and is associated with an increased risk of premature delivery.

Diagnosis

- Use a dipstick leucocyte esterase test to detect white blood cells, and a nitrate reductase test to detect nitrites.
- Microscopy of a urine specimen will show bacteria and usually white blood cells in clumps, and some- times red blood cells. Urine examination requires a clean-catch midstream specimen of urine to minimise the possibility of contamination. The results of bacterial culture, although not necessary before starting treatment, are helpful if there is treatment failure, and also for monitoring bacterial sensitivity in the population.

Treatment with antibiotics for uncomplicated cystitis

- Amoxicillin 500 mg by mouth three times a day for 5 days or cephalexin (or alternative available cephalosporin) 500 mg three times a day for 5 days.
- Trimethoprim/sulfamethoxazole 1 tablet 160/800 mg by mouth twice a day for 3 days. This drug is best avoided in pregnancy unless there is no alternative. It must be completely avoided in the first trimester. This antibiotic is a folate antagonist and therefore promotes congenital abnormalities, and in the third trimester it may cause haemolysis in the neonate.
- If treatment fails, check urine culture and sensitivity (if available), and treat with an antibiotic appropriate for the organism.

Acute pyelonephritis

Acute pyelonephritis is an acute infection of the upper urinary tract, mainly of the renal pelvis, which may also involve the renal parenchyma. It can precipitate premature labour.

- If shock is present or suspected, initiate immediate ABC treatment.
- Check urine culture and sensitivity (if available), and treat with an antibiotic appropriate for the organism.
- If urine culture is unavailable, treat with antibiotics until the woman has been fever-free for 48 hours:
 - ampicillin 2 grams IV every 6 hours
 - **plus** gentamicin 80 mg IM/IV every 8 hours or 5 mg/ kg body weight IV/IM once every 24 hours.
- Once the woman has been fever-free for 48 hours, give amoxicillin/ampicillin 500 mg by mouth three times a day to complete 14 days of treatment.
- If there is no clinical response within 72 hours, review the results and antibiotic coverage.

Alternative and/or second line treatment is with IV cephalosporins, e.g. cefuroxime 750 mg to 1.5 g 8-hourly.

- Perform a renal ultrasound scan. If any significant malformation of the kidneys or renal tract is noted, refer the patient for specialist advice.

Section 39: Varicella zoster (chickenpox) in pregnancy

Pregnant women and newborn infants are at risk of severe disease from varicella, involving serious effects on organs such as the lungs. In chickenpox, patients are infectious for 48 hours prior to emergence of the rash and until all of the skin lesions are crusted over. The incubation period is 10–21 days.

Varicella pneumonia

Pregnant women with chickenpox are more likely than non-pregnant women to develop severe pneumonitis. The risk is greatest in the third trimester, especially if lung disease is already present, or if the patient is a smoker or is immune-compromised (e.g. due to HIV infection). Symptoms start as a non-productive cough, which can rapidly progress to respiratory failure within 36–48 hours. The cough becomes increasingly productive, with tachypnoea, dyspnoea, cyanosis and chest pain.

Perinatal infection

If a neonate is exposed (mother has a rash) around the time of birth (from 5 days before to 2 days after delivery), there is a 17–30% risk of dangerous infection. This is characterised by skin lesions, disseminated intravascular coagulation, pneumonitis and hepatitis, and it has a mortality of up to 30%.

Maternal contact with varicella during pregnancy

If non-immune and an IgG test is not available and significant contact with chicken pox or shingles then give varicella zoster immunoglobulin (VZIG) within 4 days of contact if possible (maximum of 10 days after contact).

Significant exposure to chickenpox occurs after very limited contact with an infected person (any face to face contact and as little as 15 minutes in the same room as an infectious patient). The risk of contracting chicken pox from exposure to shingles is very low if the infection is not in an exposed area.

Chickenpox during pregnancy

If this is mild, give oral aciclovir (see below for dose regimen) for 7 days, starting within 24 hours of the appearance of vesicles, and avoid contact with other pregnant women. In mild cases, aciclovir leads to little improvement. It is most important in women at risk of severe disease (immuno-compromised, HIV infected, history of respiratory disease or smoking).

If it is severe, give IV aciclovir for 7 days. High-dependency care should be provided if available, as appropriate.

Prevention of neonatal chickenpox if the mother is infected from 7 days before to 7 days after birth

Give VZIG to the neonate as soon as possible after delivery. Isolate the mother and infant.

In addition, give IV aciclovir to the neonate if the onset of maternal symptoms was between 4 days before, and 2 days after the birth.

Doses of VZIG and aciclovir

In pregnancy

Aciclovir is of no benefit if commenced more than 24 hours after the appearance of chickenpox vesicles.

- Oral route: 800 mg five times daily for 7 days (mildly ill cases only).
- IV route: 10 mg/kg/dose every 8 hours for 7 days.

Side effects include nausea, vomiting, diarrhoea, headache and nephrotoxicity. Reduce the dose or dosage interval in patients with impaired renal function.

Varicella zoster immunoglobulin (VZIG): 1 gram IM. Anaphylaxis is rare, but ensure that adrenaline is available.

In the neonate

Aciclovir 10–20 mg/kg IV every 8 hours for at least 7 days. Side effects are as described above.

Varicella zoster immunoglobulin (VZIG): 250 mg by deep IM injection.

Section 40: Postnatal depression

Section 40: Postnatal depressive illness

A very serious and relatively common condition placing mother and baby at risk. The following scoring system is helpful in making the diagnosis.

Edinburgh Postnatal Depression Scale (EPDS)

Name: _____ Address: _____ Your date of birth: _____

Baby's date of birth: _____ Phone number: _____

In the past 7 days:

Question 1

In the past week I have been able to laugh and see the funny side of things:

- As much as I always could
- Not quite so much now
- Definitely not so much now
- Not at all

Question 2

In the past week I have looked forward with enjoyment to things:

- As much as I ever did
- Rather less than I used to
- Definitely less than I used to
- Hardly at all

Question 3*

In the past week I have blamed myself unnecessarily when things went wrong:

- Yes, most of the time
- Yes, some of the time
- Not very often
- No, never

Question 4

In the past week I have been anxious or worried for no good reason:

- No, not at all
- Hardly ever
- Yes, sometimes
- Yes, very often

Question 5*

In the last week I have felt scared or panicky for no very good reason:

- Yes, quite a lot
- Yes, sometimes
- No, not much
- No, not at all

Question 6*

In the past week things have been getting on top of me:

- Yes, most of the time I haven't been able to cope at all
- Yes, sometimes I haven't been coping as well as usual
- No, most of the time I have coped quite well
- No, I have been coping as well as ever

Question 7*

In the past week I have been so unhappy that I have difficulty sleeping:

- Yes, most of the time
- Yes, sometimes
- Not very often
- No, not at all

Section 40: Postnatal depression

Question 8*

In the past week I have felt sad or miserable:

- Yes, most of the time
- Yes, quite often
- Not very often
- No, not at all

Question 9*

In the past week I have been so unhappy that I have been crying:

- Yes, most of the time
- Yes, quite often
- Only occasionally
- No, never

Question 10*

In the past week the thought of harming myself has occurred to me:

- Yes, quite often
- Sometimes
- Hardly ever
- Never

Administered/reviewed by:

Date:

Instructions for using the Edinburgh Postnatal Depression Scale

- 1 The mother is asked to check the response that comes closest to how she has been feeling in the previous 7 days.
- 2 All of the items must be completed.
- 3 Care should be taken to avoid the possibility of the mother discussing her answers with others. Answers must come from the mother or pregnant woman.
- 4 The mother should complete the scale herself, unless she has limited English or has difficulty with reading.

Mothers who score above 13 are likely to be suffering from a depressive illness of varying severity. The EPDS score should not override clinical judgment. A careful clinical assessment should be undertaken to confirm the diagnosis.

The scale indicates how the mother has felt during the previous week. In doubtful cases it may be useful to repeat the tool after 2 weeks. The scale will not detect mothers with anxiety neuroses, phobias or personality disorders.

Scoring

Questions 1, 2 and 4 (without an asterisk) are scored 0, 1, 2 or 3, with the top box scored as 0 and the bottom box scored as 3.

Questions 3, 5, 6, 7, 8, 9 and 10 (marked with an asterisk) are reverse scored, with the top box scored as 3 and the bottom box scored as 0.

The maximum possible score is 30.

Possible depression is indicated by a score of ^a 10.

Always look at item 10 (suicidal thoughts).

Section 41: Emergency obstetric procedures

Urethral catheterisation

Use an appropriate size of catheter, one that is smaller in diameter than the external urethral meatus (to minimise the risk of subsequent urethral stricture formation). Usual size 10–14 French gauge.

Using sterile precautions (gloves, etc.), wash the area with gauze swabs soaked with antiseptic or sterile water or 0.9% saline and clean from anterior to posterior with downward movements (to avoid faecal contamination). Sterile lubricant should be used to aid passage of the catheter. The catheter is inserted far enough (urethra length is around 4 cm) for urine to be seen in the tube.

Use a syringe of sterile water or 0.9% saline to inflate the balloon if it is a Foley catheter, with the woman lying on her back or in the left lateral tilt position if she is more than 20 weeks' pregnant. Attach a catheter bag (if available). Secure the catheter to the thigh with tape to prevent traction damage to the bladder. The balloon must be deflated before the catheter is removed.

Figure 41.1 Normal female external genitalia showing urethra

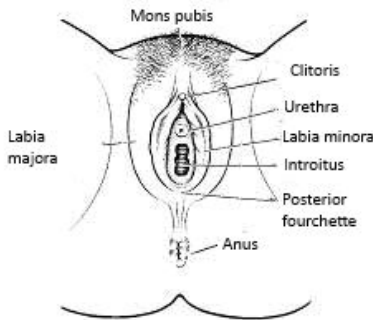

Ventouse (vacuum) delivery

The advantages of the ventouse over forceps are that less training is needed, there is less risk of excessive traction, there are clear-cut rules on its use (e.g. the number of contractions during which traction is allowed), if the baby needs to rotate in order to be delivered this can occur spontaneously, and it can cause less injury to the mother.

The disadvantages are that it cannot be used for pre-term delivery, face presentation, breech or after-coming head of breech, and if the mother is unable to provide expulsive efforts the ventouse is generally not effective.

The Bird metal cup (see Figure 41.2) has two configurations:

1 The 5 cm anterior metal cup is used for occipito-anterior positions. The smaller 4 cm cup is reserved for the small fetus (e.g. a second twin, and particularly if the cervix is no longer fully dilated).

2 The posterior metal cup is used for occipito-posterior positions, particularly those with significant deflexion. This is often also the cup of choice for the deep transverse arrest, as the abnormal angle of the baby's head to the vertical, which is often marked, makes correct placement with the anterior cup highly unlikely.

The plastic cup (50 or 60 mm internal diameter) comes in two main forms:

- a silastic/silicon soft cup (see Figure 41.3) is the safest for the fetus, but has a slightly higher failure rate, especially with occipito-posterior positions
- the easy-to-use Kiwi OmniCup (see Figure 41.4), is reusable but relatively expensive

Section 41: Emergency obstetric procedures: ventouse

Figure 41.2 The two types of Bird metal cup. (a) Anterior cup. (b) Posterior cup

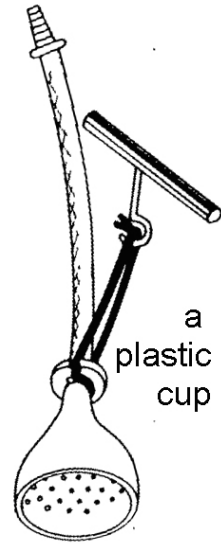
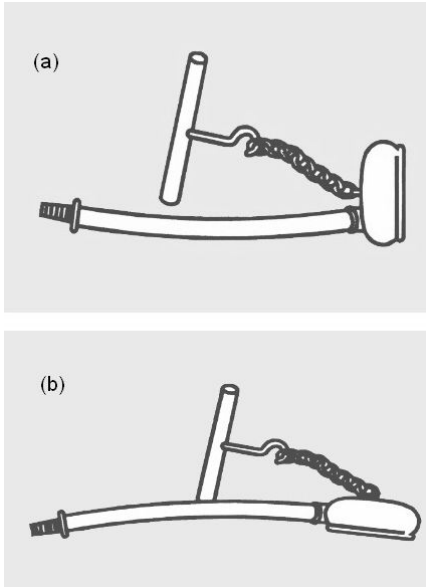

Figure 41.3 A soft plastic cup

Indications for an assisted delivery using the vacuum extractor

- Delay in the second stage of labour.
- Fetal distress in the second stage.
- Maternal conditions that require a short second stage (e.g. eclampsia, heart disease).
- Maternal exhaustion.

Contraindications

- Face presentation.
- Gestation less than 34 weeks.
- Breech presentation.
- Signs of obstructed labour.

Prerequisites

- Full dilatation of the cervix and engagement of the head (head at least at 0 station and no more than 1/5 above the symphysis pubis).
- The position of the fetal head in relation to the pelvis must be known.
- A fetus greater than 36 weeks' gestation, or with great care if between 34 and 36 weeks.
- Cooperation of the mother is helpful so that she can enhance contractions and traction by bearing down.
- Uterine contractions must be present.
- Ensure that a healthcare worker who is able to undertake neonatal resuscitation is present in case this is required.
- Ensure that the equipment is working, in particular that the vacuum reaches the correct value by testing the cup on the palm of the hand of the operator (covered by a sterile glove).

Basic rules

1. If the patient is mobile, ask them to empty their bladder. If not, catheterise them. If the patient is catheterised, ensure that any within-catheter balloon is deflated.

Section 41: Emergency obstetric procedures: ventouse

2. No additional anaesthetic is required (perineal infiltration with lidocaine will suffice if an episiotomy is planned).
3. Lithotomy is the commonest position used, but delivery may be possible in a dorsal, lateral or squatting position. The mother should be in a 45-degree sitting position to aid expulsion.
4. The delivery should be clearly achievable after three pulls, with evidence of descent with each pull.
5. The head, not just the scalp, should descend with each pull.
6. The cup should be reapplied no more than twice provided that it has been in the right position and the direction of pull is correct (and after one detachment an experienced operator, if available, should be summoned).
7. If failure with the ventouse occurs despite good traction, do not try the forceps but proceed to Caesarean section (provided that it is safe, and available within a reasonable time).

Methods for all ventouse systems

First check your equipment. Attach the cup to the suction, and ensure the suction is working by testing it. This can be done by briefly holding the cup against your hand while suction is applied.

1 Examine the mother carefully using a sterile procedure and gloves and ideally an obstetric cream such as Chlorhexidine/Hibitane. Estimate the size of the baby by abdominal examination, and ensure that the head is fully engaged (no more than 1/5 of the head should be palpable). The membranes should have ruptured.

2 Determine the position of the vertex and the amount of caput by vaginal examination. Identify the posterior fontanelle.

3 Describe the attitude of the presenting part as 'flexed' or 'deflexed'. In a flexed attitude only the posterior fontanelle can be felt, whereas any situation in which the anterior fontanelle can be felt or the posterior fontanelle cannot be found should be described as deflexed.

4 With two fingers press on the perineum posteriorly to widen the vaginal opening (see Figure 41.4).

Figure 41.4 Inserting a Malmström cup

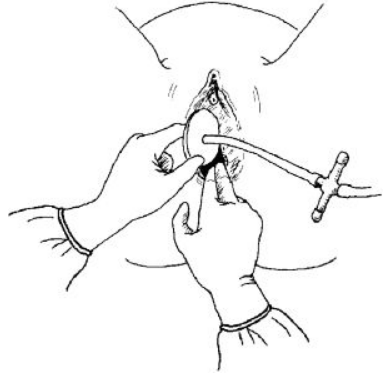
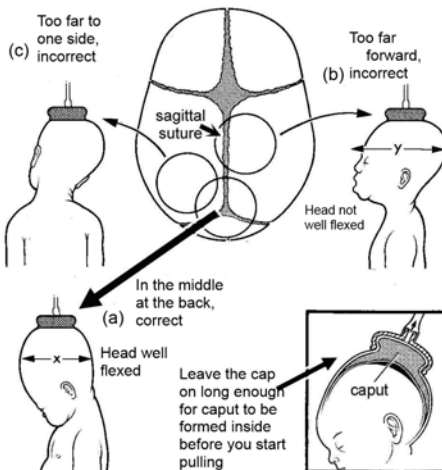

Figure 41.5 Correct and incorrect positions for the cup



Section 41: Emergency obstetric procedures: ventouse

- 5 Insert the cup, avoiding the urethra. Apply the largest cup that will fit, with the centre of the cup over the flexion point, 2–3 cm anterior to the posterior fontanelle (see Figures 39.5 and 39.6). This placement will promote flexion, descent and autorotation with traction. Suction is applied to draw the fetal scalp into the cup.

Figure 41.6 Flexion point

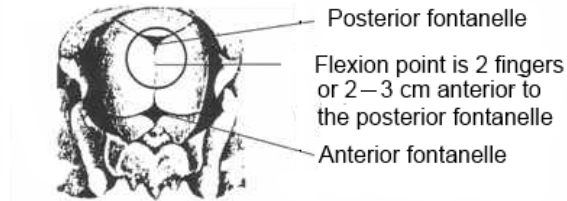

- 6 Ensure that no maternal tissue is caught under the edge of the cup.
- 7 Place the middle of the cup 1–2 cm anterior to the baby's posterior fontanelle/posterior to the anterior fontanelle. This will flex the head during its passage through the pelvis.
 - If you put it more towards the front it will tend to extend the head, so that it will be less easy to pull out. The distance 'Y' when the head is deflexed (bent backwards) is much longer than the distance 'X' when it is flexed (bent forward).
 - If you put the cup to one side, the head will bend to one side.
- 8 Connect the cup to the pump (and check for leaks prior to commencing the delivery).
 - Increase the pressure to 0.2 kg/cm^2 , and then, after checking again that there is no maternal tissue caught under the cup, increase the pressure to 0.8 kg/cm^2 , but never any higher than this.
 - Common problems with reaching the correct pressure include suction bottles not tightly screwed in or tubing loosely attached to the metal cup.
 - The metal cup should have a meshed bottom plate, which functions to maintain a clear space between the scalp and the cup so that an effective vacuum can be applied.

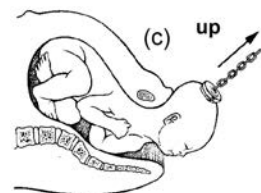
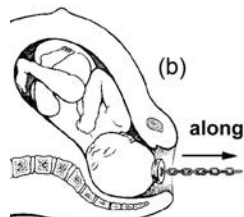
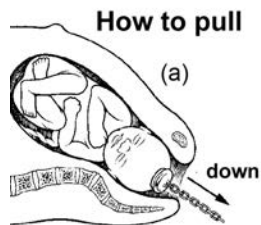

Figure 41.7 Delivery with the Bird anterior metal cup

Section 41: Emergency obstetric procedures: ventouse

- 9 Only perform an episiotomy when the head stretches the perineum (to avoid blood loss), and only if the perineum is interfering with the delivery.
- 10 Check the application. Ensure that there is no maternal soft tissue (cervix or vagina) within the rim.
- 11 During a contraction, encourage the patient to push, and aid her expulsive efforts by applying traction to the cup/fetal head (method described below).

Note the following:

- Never use the cup to actively rotate the baby's head. Rotation of the baby's head will occur naturally with traction, if it is going to rotate.
- Do not continue to pull between contractions and expulsive efforts.
- With progress, and in the absence of fetal distress, continue the 'guiding' pulls to achieve delivery. Descent must be seen with each pull, and delivery should be clearly achievable following three pulls.

Delivery with the anterior metal or plastic cup

The metal or plastic cup is lightly lubricated with sterile delivery cream (e.g. chlorhexidine cream) and then inserted sideways into the vagina. To orientate the cup correctly, direct the chain towards the occiput, which will result in the vacuum pipe lying centrally. Take the pressure up to 0.2 kg/cm^2 . Check that no maternal tissue is caught under the cup and then increase the pressure directly to 0.8 kg/cm^2 , but never any higher than this. Begin traction with the next contraction after this pressure has been achieved.

Traction should be along the pelvic axis for the duration of the contraction (initially down, then progressively forwards, and finally upwards as the head delivers) and always perpendicular to the cup (see Figure 41.7). Always pull in the direction of the birth canal.

- 1 Pull downwards towards the floor until the head is below the ischial spines.
- 2 Pull outwards until the head is stretching the perineum.
- 3 Finally pull upwards until the baby is delivered.

During traction keep one finger or thumb on the edge of the cup and another finger on the scalp so that the earliest sign of detachment or slippage is detected (see Figures 41.8 and 41.9).

With each contraction apply traction in a line perpendicular to the plane of the cup rim to help to prevent the cup slipping off (see Figure 39.9). Place a finger on the scalp next to the cup during traction to assess potential slippage and descent of the vertex (see Figure 39.8). Slight side-to-side movements may help to edge the head down the pelvic wall, but side-to-side movements must be small to keep the traction line perpendicular and prevent the cup from detaching.

Figure 41.8 How to ensure that the vacuum cup is securely on the infant's head as you pull

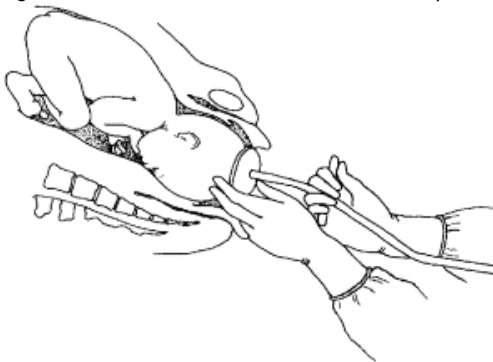

Section 41: Emergency obstetric procedures: ventouse

Figure 41.9 Guiding the cup with the fingers to detect any slippage while pulling



Figure 41.10 Cup slipping off with sideways traction

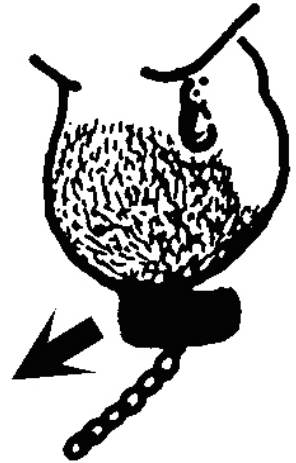

As the head crowns, the angle of traction changes through an arc of over 90 degrees (figure 41.7).

If the perineum is stretching as normal, it is supported with the hand that was on the cup. An episiotomy should only be undertaken if perineal resistance is preventing delivery.

Occasionally, an edge of the cup might lift off at the introitus (this is more likely to happen if there is caput present). If this occurs, one has to be careful not to catch maternal tissue under the cup as it re-attaches. Therefore this should be rechecked before final delivery of the head.

Once the head has delivered, release the vacuum and take off the cup and complete the delivery normally.

Delivery with the posterior metal cup

For a deflexed head in an occipito-posterior position, the 'OP' cup or, if this is not available, a plastic cup, ideally a Kiwi OmniCup, should be used. It is applied as far back on the head as possible, again ideally in the midline over the occiput. To allow good placement of the cup, it sometimes helps to try to flex the head, with two fingers of the left hand pressing on the sinciput, while the right hand inserts the cup behind the head. Once correctly placed, the vacuum can be started and taken directly to the required level. (Because the cup lies parallel to the vagina it is

Section 41: Emergency obstetric procedures: ventouse

unlikely to catch any maternal tissue.) The first pull will be in the direction required to flex the head. With flexion of the head, the presenting diameter immediately becomes less. Thereafter, traction will be along the pelvic axis. The delivery may be completed simply by a standard spontaneous rotation of the baby with maternal effort and gentle assistance. It is essential not to try to twist the cup to rotate the baby. This will cause trauma, especially spiral tears of the scalp, with the rotational deliveries.

Overall, occipito-posterior deliveries are the most likely to cause problems. The most difficult ones are those where the head is markedly deflexed or where there is excessive caput. Another difficulty sometimes encountered is that the suction pipe tends to kink once the head flexes, making the cup more likely to detach. If the cup detaches at this point (after flexion and rotation), put it back on again or perform a lift-out forceps.

Between contractions, check the fetal heart rate and secure application of the cup.

Causes and management of failure to deliver with the ventouse

Vacuum extraction has failed if:

- the head does not advance with each pull
- the fetus is not delivered or delivery is not imminent after three pulls
- the cup slips off the head twice at the proper direction of pull with a maximum negative pressure.

Every application should be considered a trial of vacuum extraction. Do not persist if there is no descent with every pull.

Generally delivery is achieved with three pulls. As a minimum, it should be clear after three pulls that the delivery is definitely going to be achieved imminently by the vaginal route.

Failures occur for the following reasons.

- 1 Inadequate initial assessment of the case:
 - The head being too high: a classic mistake is to assume that because caput can be felt below the ischial spines, the head must be engaged.
 - Misdiagnosis of the position and attitude of the head: attention to simple detail will minimise this.
- 2 Anterior or lateral placements will increase the failure rate.
 - If the cup placement is found to be incorrect, it may be appropriate to begin again with correct placement (i.e. midline over the flexion point).
- 3 Failures due to traction in the wrong direction.
 - Gentle sustained traction in the correct direction is what is needed, and sideways movements will be ineffective and increase scalp trauma and cup detachments.
- 4 Excessive caput.
 - Rarely, even with metal cups, adequate traction is not possible because of excessive caput.
 - In these cases, consideration must be given to delivery by Caesarean section unless the head is well down, in which case forceps can be used.
- 5 Poor maternal effort.
 - Maternal effort can contribute substantially to success.
 - Adequate encouragement and instruction should be given to the mother.
 - This may be a reason for preferring forceps to ventouse if the patient is already under general anaesthetic.
- 6 The incidence of cephalo–pelvic disproportion (CPD) (true failure) is low. However, in settings where the majority of women deliver at home or in community clinics, it must be remembered that the patient is likely to have been fully dilated for some time before arrival in the hospital, if she has been referred for failure to progress in the second stage. CPD is likely to be relatively more common in this group.
If vacuum extraction fails, consider vacuum extraction in combination with symphysiotomy (see below) or perform Caesarean section.

Section 41: Emergency obstetric procedures: ventouse

Vacuum extraction and symphysiotomy

Vacuum extraction may be used in combination with symphysiotomy in the following circumstances:

- the head is at least at –2 station or no more than 2/5 palpable above the symphysis pubis
- Caesarean section is not feasible or immediately available
- the provider is experienced and proficient in performing symphysiotomy
- vacuum extraction alone has failed or is expected to fail
- there is no major degree of disproportion.

Complications of vacuum extraction

Complications usually result from not observing the conditions of application, or from continuing efforts beyond the time limits stated above.

Fetal complications

- Localised scalp oedema (artificial caput or chignon) under the vacuum cup is harmless and disappears within a few hours.
- Cephalhaematoma requires observation, and will usually clear in 3 to 4 weeks.
- Scalp abrasions (common and harmless) and lacerations may occur. Clean and examine lacerations to determine whether sutures are necessary. Necrosis is extremely rare.
- Sub-galeal haemorrhage is more serious.

There have been reports of transmission of herpes viral infections from the mother to the fetal scalp following the use of a metal cup. It is theoretically possible that hepatitis or HIV infection may also be transmitted in this way.

There is a lower risk of scalp injury using the flexible/plastic cups. Therefore for straightforward ventouse deliveries use the flexible cup when possible, bearing in mind that where rotation is needed as part of the delivery the metal cup is more successful. The metal cup can also deliver a stronger traction force.

Maternal complications

Tears of the genital tract may occur. Examine the woman carefully and repair any tears to the cervix or vagina, or undertake episiotomy repair.

Special indications for delivery with the ventouse

With the exception of second twin deliveries (where the cervix is in effect recently parous), vacuum extraction *before full dilatation* is generally only possible in multiparous women where the cervix is soft and easily stretchable. This is definitely not always the case even with multiparous women, and great caution must be taken before proceeding to any vaginal delivery before full dilatation. Complications of such deliveries include cervical tears that can extend upward to involve the uterus, and therefore may require laparotomy for repair or even hysterectomy as for a ruptured uterus.

If the operator is uncertain about the degree of engagement, degree of cervical dilatation or the position of the head, a more experienced practitioner should assist (if available).

Forceps delivery after failure to deliver with the ventouse

There is no place for an attempt at forceps delivery if there has been no descent with the ventouse despite adequate traction. However, if traction has been inadequate (due to caput, leaking equipment or no maternal assistance), it may be justified to change to forceps. The most experienced operator should make this decision.

Forceps delivery

Forceps are particularly helpful in the delivery of the after-coming head of a breech, delivery of a mento-anterior face presentation, and delivery before 34 weeks (although this is controversial).

Conditions for possible use of forceps

These include the following:

Section 41: Emergency obstetric procedures: forceps

- vertex presentation
 - face presentation with chin anterior
 - entrapped after-coming head in breech delivery; some operators will routinely control the delivery of the head here by using forceps, provided that the cervix is fully dilated.
- At the very minimum, the sagittal suture should be in the midline and straight, guaranteeing an occiput-anterior or occiput-posterior position.

Outlet forceps

In resource-limited settings, forceps at the outlet can be helpful for delay in the second stage when the baby's head is near the outlet, but for all other situations the ventouse is preferred if suitable. The conditions for the use of outlet forceps are as follows:

- the fetal scalp is visible without separating the labia
- the fetal skull has reached the pelvic floor
- the sagittal suture is in the antero-posterior diameter or right or left occiput-anterior or occiput-posterior position (rotation does not exceed 45 degrees)
- the fetal head is at or on the perineum.

The blade on the mother's left always goes in first, and the right blade fits on top of it.

Procedure

- Ensure that the head is engaged in the pelvis. Abdominal palpation must be undertaken, particularly in the case of face presentation.
- Urinary catheterisation is required.

Figure 41.11 Outlet forceps

- Pudendal block and perineal infiltration with 1% lignocaine is required.
- An episiotomy is usually required.
- Identify the position of the head. Occipito-transverse or occipito-posterior positions are indications for ventouse, and if the head is deflexed, for using the OP ventouse cup or Kiwi OmniCup.
- Ensure that the pair of forceps match. Assemble them and check. It may be useful to check the maximum diameter between the blades, which must be at least 9 cm.
- Lubricate the blades of the forceps with disinfectant cream (e.g. Hibitane).
- Wearing sterile gloves, insert two fingers of the right hand into the vagina on the side of the fetal head. Slide the left blade gently between the head and fingers to rest on the side of the head (see Figure 41.11).

A biparietal bimalar application is the only safe option.

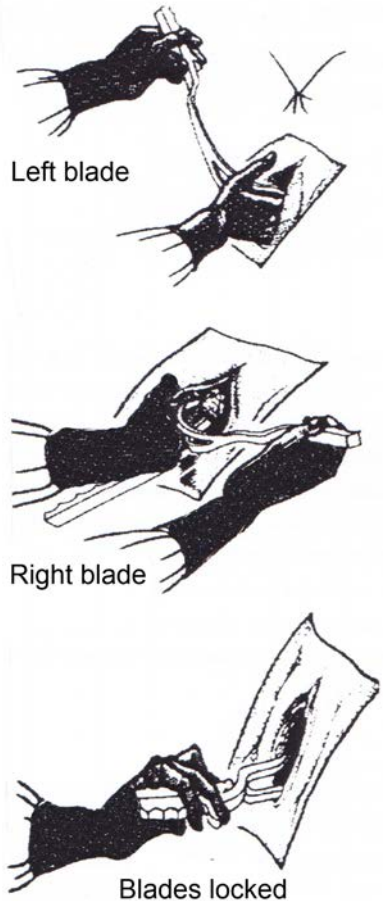

Section 41: Emergency obstetric procedures: forceps

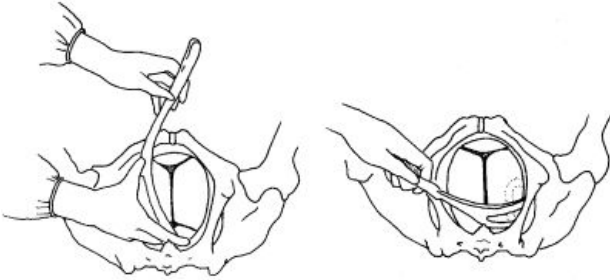

Figure 41.12 Applying the left blade of the forceps

Repeat the same manoeuvre on the other side, using the left hand and the right blade of the forceps (see

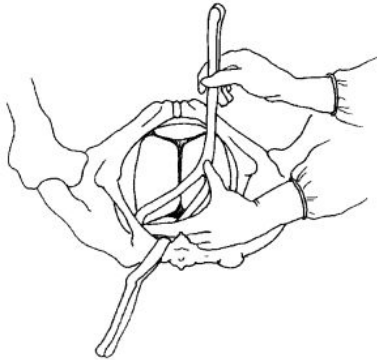

Figure 41.13 Applying the right blade of the forceps

- Depress the handles and lock the forceps.
- Difficulty in locking usually indicates that the application is incorrect. In this case, remove the blades and recheck the position of the head. Reapply only if the head is in the appropriate position for the use of forceps.
- After locking check that the sagittal suture lies vertically in the midline between the shanks of the forceps. Also ensure that no more than two fingers can be placed laterally into the fenestrations of the blades. Note: these checks do not ensure correct placement but do help detect some instances of mal-placement.
- After locking, apply steady traction inferiorly

and posteriorly with each contraction (see Figures 41.14 and 41.15). There should be both traction and pressure on top of the joined

forceps.

Figure 41.14 Locking the handles

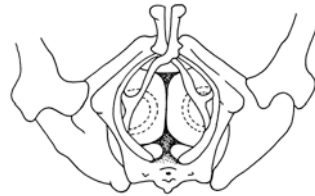
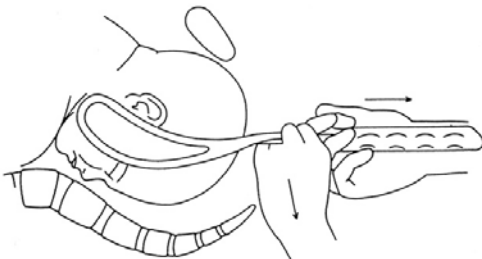

Figure 41.15 The correct way of applying traction with downward pressure

Between contractions check the fetal heart rate and correct application of forceps.

- When the head crowns, make an adequate episiotomy.
- Lift the head slowly out of the vagina between contractions.



Section 41: Emergency obstetric procedures: forceps

- The head should descend with each pull. Only two or three pulls should be necessary.
- Ensure that the head rather than the blades of the forceps are descending with each pull by feeling the fingers on the fetal head moving down. It is very harmful to the fetus if the blades slide down the side of the fetal head.

Failure of forceps

- The fetal head does not advance with each pull.
- The fetus is not delivered after three pulls.

Every application should be considered a trial of forceps. Do not persist if there is no descent with every pull.

If forceps delivery fails, consider a symphysiotomy or perform a Caesarean section.

- After repairing any episiotomy, ensure that swab and instrument counts are correct.
- Do a rectal examination to check the integrity of the rectal sphincter and the mucosa for tears.

Complications of forceps use

Fetal complications

- Injury to facial nerves requires observation. This injury is usually self-limiting.
- Lacerations of the face and scalp may occur. Clean and examine any lacerations to determine whether sutures are necessary.
- Fractures of the face and skull require close monitoring.

Maternal complications

Tears of the genital tract may occur. Examine the woman carefully and repair any cervical or vaginal tears and under- take episiotomy repair.

Caesarean section

The WHO suggests that systems should be in place to ensure that Caesarean section is performed in a minimum of 5% of all expected births.

Indications

- Obstructed labour.
- Obstetric haemorrhage (especially if ongoing or the mother or fetus is unstable).
- Severe maternal illness where urgent delivery is indicated and is not achievable rapidly by vaginal delivery (e.g. eclampsia where delivery is advised within 12 hours).
- Fetal distress.
- Malpresentation.
- Major placenta praevia.

Pre-operative considerations

- Check for fetal life by listening to the fetal heart rate.
- Examine for fetal presentation and to ensure vaginal delivery is not achievable.
- Avoid performing a Caesarean section if there is no maternal indication and the fetus is dead.
- Obtain informed consent from the mother.
- Take a blood sample for haemoglobin or haematocrit, blood grouping and cross-matching if indicated. More than 2 × 500 mL units may be needed if antepartum bleeding or massive haemorrhage is anticipated.
- Transfer the patient to the operating theatre in the left lateral position with a wedge under the right buttock.
- Give antacid immediately prior to general anaesthetic (30 mL of 0.3% sodium citrate (preferable non-particulate) or 300 mg of magnesium trisilicate). This neutralises the stomach acid and minimises damage to the lungs if aspiration occurs.
- Start an IV infusion with a crystalloid such as Ringer- lactate or Hartmann's solution.
- Spinal or general anaesthesia with rapid sequence induction, or ketamine, or local infiltration may be used, depending on local circumstances. (For choice of anaesthesia, see Textbook)

Section 41: Emergency obstetric procedures: caesarean section

In theatre, the operating table must be kept in the left lateral tilt position or a pillow placed under the woman's right lower back to reduce aorto-caval compression until after delivery.

- Urinary catheterisation

The woman must be catheterised and her bladder emptied before starting the procedure, both to avoid injury to the bladder and to monitor urine output.

Remove the catheter after 8 hours if the urine is clear; if not, wait until it is.

Wait 48 hours before removing the catheter if there is:

- uterine rupture
- prolonged or obstructed labour
- gross perineal oedema
- puerperal sepsis with pelvic peritonitis.

If the bladder was damaged, leave the catheter in for 7 days. The urine should be clear of blood and remain so after 48 hours. If the woman is not receiving antibiotics, give nitrofurantoin 100 mg (or cefalexin 500 mg or amoxicillin 500 mg) orally once daily until the catheter has been removed.

See Textbook for details of how to undertake caesarean section.

Post-operative care

- Bowel function should be normal after 12 hours.
- If progress is uncomplicated, give liquids immediately and solids when the patient is passing gas per rectum.
- If there is infection, obstructed labour or uterine rupture, wait until bowel sounds reappear before giving oral fluids.
- Keep a dressing on the wound for 24 hours to ensure re-epithelialisation.
- If blood is leaking, reinforce the dressing or replace it with a new one if it is more than half soaked.

If bleeding occurs:

- Massage the uterus to expel blood and blood clots. The presence of blood clots will inhibit effective uterine contractions:
 - Give oxytocin 5 units IV slowly or 10 units IM and then infuse 40 units in 500 mL of IV fluids (Ringer-lactate or Hartmann's solution) over 4 hours
 - or ergometrine 500 micrograms IM or misoprostol 400 micrograms sublingually or orally provided that the mother is fully conscious
 - or misoprostol 800 micrograms rectally if the mother is drowsy or unconscious.

These drugs can be given together or sequentially.

- If there are signs of infection or the mother has a fever, give a combination of antibiotics until she has been fever-free for 48 hours:
 - Ampicillin 2 grams IV every 6 hours
 - **plus** gentamicin 80 mg IV/IM every 8 hours or 5 mg/kg body weight IV/IM once every 24 hours
 - **plus** metronidazole 500 mg IV every 8 hours.
- Give appropriate analgesic drugs.

Discharge the mother home when her temperature has been normal for at least 24 hours, and she is mobilising and able to eat and drink normally.

Symphiotomy

Symphiotomy is performed for the management of cephalo-pelvic disproportion in selected situations in resource-limited countries or ill-equipped obstetric units. It may be required for the delivery of the trapped after-coming head with a breech delivery, or for shoulder dystocia.

Symphiotomy results in a temporary increase in pelvic diameter (up to 2 cm) by surgically dividing the cartilage of the symphysis under local anaesthesia. Symphiotomy in combination with vacuum extraction is a life-saving procedure in areas where Caesarean section is not immediately available.

Section 41: Emergency obstetric procedures: symphysiotomy

Symphysiotomy leaves no uterine scar, so the risk of ruptured uterus in subsequent pregnancies is not increased. Caesarean section can have high morbidity and mortality rates in resource-limited healthcare facilities. Mortalities of up to 5% and uterine scar rupture in 7% of subsequent pregnancies have been reported. Symphysiotomy has a very low maternal mortality, with 3 deaths reported in a series of 1752 symphysiotomies. These deaths were unrelated to the procedure.

However, symphysiotomy has risks of complications, which include urethral and bladder injury, infection, pain and long-term difficulty in walking. Therefore it should only be performed when there is no safe alternative.

Symptoms following symphysiotomy include pain in the symphysis pubis and groin, hip or thigh pain, backache and stress incontinence.

See Textbook for details of how to undertake this procedure.

Post-procedure care

- If there are signs of infection or the mother has a fever, give a combination of antibiotics until she has been fever-free for 48 hours:
 - Ampicillin 2 grams IV every 6 hours
 - **plus** gentamicin 80 mg IV/IM every 8 hours or 5 mg/ kg body weight IV/IM once every 24 hours
 - **plus** metronidazole 500 mg IV every 8 hours.
- Give appropriate analgesia.
- Apply a binder or sheet or elastic strapping across the front of the pelvis from one iliac crest to the other to hold the pelvis together to aid pelvic healing and reduce pain. Nurse the woman on her side to allow gravity to aid pelvic healing.
- Leave the urinary catheter in for at least 5 days.
- Encourage oral fluids to ensure a good urinary output.
- Encourage bed rest for 7 days after discharge from hospital.
- Encourage the mother to begin walking with assistance when she is ready to do so.
- If long-term walking difficulties and pain occur (2% of cases), treat them with physiotherapy.

Destructive operations

Destructive procedures are undertaken when a vaginal delivery must occur because:

- skilled staff are not available to carry out what may be a difficult or dangerous Caesarean section
- in neglected obstructed labour there is a risk of overwhelming infection following Caesarean section
- of the implications of a uterine scar for future pregnancies
- the patient does not give consent to Caesarean section.

Reasons for fetal death in obstructed labour

- Strong and continuous contractions (sometimes made worse by inappropriate use of oxytocic drugs or other non-prescription uterotonic drugs) interfere with placental exchange.
- Excessive moulding of the head, in cephalic presentation, can lead to intracranial haemorrhage. In breech presentation the head may be trapped by an incompletely dilated cervix, or may not enter the pelvis because of disproportion.
- Prolapsed cord.
- Ascending infection, amnionitis and intrauterine infection due to prolonged ruptured membranes and labour, and/ or unsterile vaginal examinations.
- Ruptured uterus.

General issues relating to destructive procedures

The procedure can be performed under general or regional anaesthesia, or sedation and analgesia with morphine, midazolam and/or ketamine.

Section 41: Emergency obstetric procedures: destructive procedures

- Before a destructive procedure is undertaken the fetus must be dead.
- Ensure that the mother is adequately resuscitated.
- Ruptured uterus must be excluded.
- Ensure adequate analgesia or anaesthesia.
- The operator must be competent at destructive deliveries.
- Destructive operations are most safely done at full dilatation, but may be performed when the cervix is 7 cm or more dilated. If there is hydrocephaly, it is best to drain the CSF at diagnosis without waiting for full dilatation, as the hydrocephalic head may cause uterine rupture.
- The bladder must be catheterised.
- Post-delivery care includes continuous catheterisation of the bladder, IV antibiotics and IV fluids.

See Textbook for details of how to undertake destructive procedures.

Post-procedure care

- After delivery, examine and repair any tears to the cervix or vagina, or undertake episiotomy repair.
- Leave a self-retaining catheter in place until bladder injury has been excluded.
- Ensure adequate fluid intake and urinary output.

Episiotomy

Episiotomy should be considered in the case of:

- complicated vaginal delivery (e.g. breech, shoulder dystocia, forceps, vacuum delivery)
- scarring from female genital mutilation/cutting
- fetal distress
- delay in the second stage
- previous third- or fourth-degree tears
- where significant perineal trauma is anticipated if it is not performed.

Procedure

- Apply antiseptic solution to the perineal area.
- Use local infiltration with 1% lignocaine. Make sure that there are no known allergies to lignocaine or related drugs.
- Infiltrate beneath the vaginal mucosa, beneath the skin of the perineum and deeply into the perineal muscle (see Figure 41.16) using 5–10 mL of 1% lignocaine solution.
- Aspirate (pull back on the plunger) to be sure that no vessel has been penetrated. If blood is returned in the syringe with aspiration, remove the needle. Recheck the position carefully and try again. Never inject if blood is aspirated.
- After local anaesthetic infiltration, wait for 2 minutes and then pinch the incision site with forceps. If the mother feels the pinch, wait a further 2 minutes and then retest.

Figure 41.16 Infiltration of the perineum with local anaesthetic

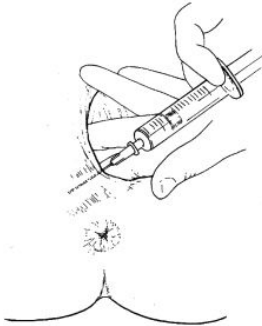

Do not perform an episiotomy until the perineum is thinned out and 3–4 cm of the baby's head are visible during a contraction. Performing an episiotomy will cause bleeding, so it must not be done too early.

1 Wearing disinfected gloves, place two fingers between the baby's head and the perineum.

2 Use scissors to cut the perineum about 3–4 cm in the medio-lateral direction (see *Figure 41.17*). It is essential that the episiotomy cut is not made where, if it runs into a tear, it involves the anal sphincter. That is, it must be at an angle away from the anus, as shown in *Figure 41.17*.

3 Control the baby's head and shoulders as they deliver, ensuring that the shoulders have rotated to the midline to prevent an

extension of the episiotomy.

4 Carefully examine for extensions and tears, and repair them (see below).

Section 41: Emergency obstetric procedures: episiotomy

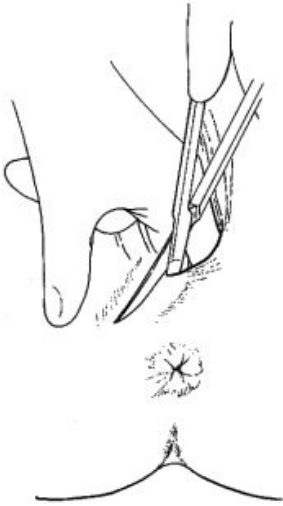

Repair of episiotomy

It is important that absorbable sutures or Vicryl are used for closure. Polyglycolic sutures are preferred to chromic catgut because of their tensile strength, non-allergenic properties and lower risk of infection and episiotomy breakdown. However, chromic catgut is an acceptable alternative.

1. Apply antiseptic solution to the area around the episiotomy.
2. If the episiotomy is extended (torn) through the anal sphincter or rectal mucosa, which should not happen if the original cut has been away from the vertical (see above), manage as third- or fourth-degree tears, respectively.
3. Close the vaginal mucosa using continuous 2-0 suture.
4. Start the repair about 1 cm above the apex (top) of the episiotomy. Continue the suture to the level of the vaginal opening.
5. At the opening of the vagina, bring together the cut
6. edges of the vaginal opening.
7. Bring the needle under the vaginal opening and out through the incision and tie.
8. Close the perineal muscle using a continuous 2-0 suture.
9. Close the skin using a sub-cuticular or interrupted 2-0 suture.

Figure 41.17 Using two fingers to protect the baby's head while making the incision

Complications of episiotomy

- 1 Haematoma. If this occurs, open and drain it. If there are no signs of infection and bleeding has stopped, reclose the episiotomy.
- 2 If there are signs of infection, open and drain the wound. Remove infected sutures and debride the wound:
 - If the infection is mild, antibiotics are not required.
 - If the infection is severe but does not involve deep tissues, give a combination of antibiotics:
 - Ampicillin 500 mg orally four times a day for 5 days
 - **plus** metronidazole 400 mg orally three times a day for 5 days.
 - If the infection is deep and involves muscles, give a combination of antibiotics until the necrotic tissue has been removed and the mother has been fever-free for 48 hours:
 - penicillin G, 2 million units IV every 6 hours
 - **plus** gentamicin 80 mg IV/IM every 8 hours or 5 mg/kg body weight IV/IM once every 24 hours
 - **plus** metronidazole 500 mg IV every 8 hours.
 - When the mother has been fever-free for 48 hours, give:
 - ampicillin 500 mg orally four times a day for 5 days
 - **plus** metronidazole 400 mg orally three times a day for 5 days.

Necrotic tissue requires wide surgical debridement. Perform secondary closure in 2 to 4 weeks (depending on resolution of the infection).

Repair of cervical tears

- If the mother is bleeding heavily it may be best to resuscitate and then pack the tear with sterile gauze. Bimanual compression may be required. Ensure that whoever repairs this is experienced. This might need referral to another hospital.
- Repair only when the mother is stable and most of the bleeding has stopped, unless there is heavy on-going blood loss despite compression in which case repair needs to be undertaken urgently while resuscitation continues
- Apply antiseptic solution to the vagina and cervix.

Section 41: Emergency obstetric procedures: cervical tear

- Anaesthesia is not required for most cervical tears.
 - For tears that are high and extensive, give morphine 10 mg IV slowly over 5 minutes (provided that shock is not present), or use ketamine.
- Ask an assistant to massage the uterus and provide fundal pressure.
- Gently grasp the cervix with ring or sponge forceps.
- Apply the forceps on both sides of the tear and gently use the forceps to pull each part of the cervix down in turn so that the entire cervix is examined.
- There may be several tears.
- One way of finding a high tear is to insert a suture as high as possible and then use it to provide traction to work up to the apex to obtain haemostasis, and then to work downward towards the introitus.
- Close the cervical tears with a continuous polyglycolic/Vicryl suture starting at the apex (upper edge of tear), which is often the source of bleeding (see *Figure 41.18*).

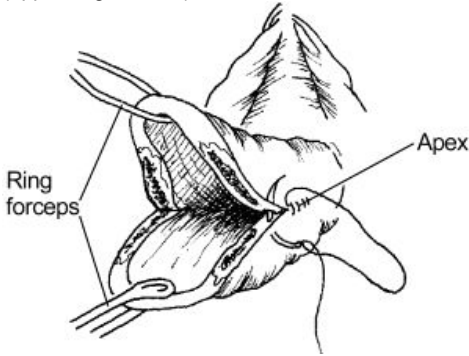

Figure 41.18 Repair of a cervical tear

- If a long section of the rim of the cervix is tattered and bleeding, under-run it with a continuous polyglycolic/Vicryl suture. Often if the bleeding is persistent but mild, compressing the ragged edges with a sterile pack is the most effective way of halting the bleeding, if no specific delineated tear is identified.
- If the apex is difficult to reach and ligate, it may be possible to grasp it with artery or ring forceps. Leave the forceps in place for 4 hours.
 - Do not persist in attempts to ligate the bleeding points, as this may increase the bleeding.
 - After 4 hours, open the forceps partially but do not remove.
 - After another 4 hours, remove the forceps completely.
- A laparotomy may be required to repair a cervical tear that has extended beyond the vaginal vault.

Manual removal of the placenta

If the placenta does not separate within 1 hour of delivery, or immediately if there is heavy bleeding:

- start an IV infusion
- ensure that the bladder is emptied either by the mother or by catheterisation
- give a slow IV injection of ketamine (1–2 mg/kg or 50–100 mg) or morphine (10 mg), ideally in the presence of an anaesthetist
- give a single dose of prophylactic antibiotics:
 - ampicillin 2 grams IV **plus** metronidazole 500 mg IV
 - or cefotaxime 1 gram IV **plus** metronidazole 500 mg IV.
- Ensure full aseptic drapes.
- Hold the umbilical cord with a clamp. Pull the cord gently until it is taut.

Section 41: Emergency obstetric procedures: manual removal placenta

- Wearing sterile gloves (ideally covering the forearms) insert a hand into the vagina and follow the cord up into the uterus until you reach the edge of the placenta (see *Figure 41.19*). If the cervix is closed, gentle pressure with one or two fingers will usually relax it and make it open.
 - Let go of the cord with the other hand and move the hand up over the abdomen in order to support the fundus of the uterus and to provide counter-traction during removal to prevent inversion of the uterus (see *Figure 41.20*).
- If uterine inversion occurs, reposition the uterus immediately.
- Move the fingers of the hand laterally until the edge of the placenta is located.
 - If the cord has been detached previously, insert a hand into the uterine cavity.

Figure 41.19 Entering the uterus along the cord

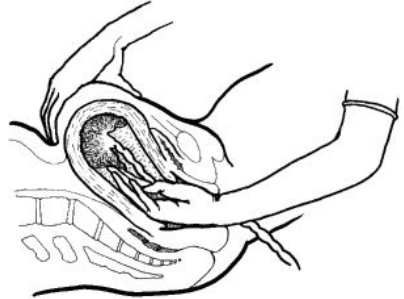
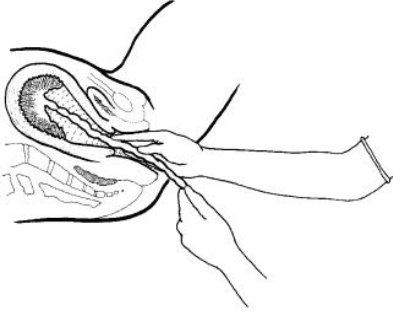
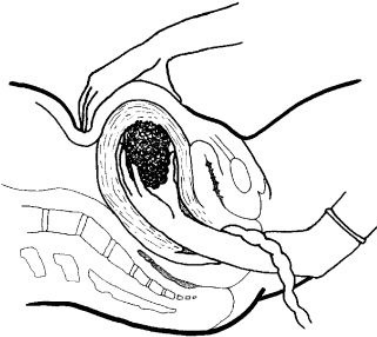

Figure 41.20 Exploring the entire cavity until a line

of cleavage is identified between the placenta and the uterine wall

- Reach the placenta from the implantation site by keeping the fingers tightly together and using the edge of the hand to gradually make a space between the placenta and the uterine wall.
- Proceed slowly all around the placental bed until the whole placenta is detached from the uterine wall.
- If the placenta does not separate from the uterine surface by gentle lateral movement of the fingertips at the line of cleavage, suspect placenta accreta.
 - Consider laparotomy and possible subtotal hysterectomy.
 - Alternatively, the placenta can be left in situ to spontaneously degenerate.
 - The main risk is that of infection and delayed haemorrhage, and follow-up needs to be maintained to assess the woman for signs of sepsis.
- Hold the placenta and slowly withdraw the hand from the uterus, bringing the placenta with it (see *Figure 41.21*).
- With the other hand, continue to provide counter-traction to the fundus by pushing it in the opposite direction to the hand that is being withdrawn.

Figure 41.21 Withdrawing the hand plus the placenta from the uterus



- Palpate the inside of the uterine cavity to ensure that all placental tissue has been removed.
- Give oxytocin 40 units in 500 mL of IV fluids (Ringer- lactate or Hartmann's solution) over 4 hours.
- Ask an assistant to massage the fundus of the uterus to encourage a tonic uterine contraction.
- If there is continued heavy bleeding, give 10 units of oxytocin IM. If this does not work, try ergometrine 200–500 micrograms (not if there is or has been hypertension) IM and, if that does not work, give misoprostol rectally as 4 × 200 microgram tablets or pessaries (800 micrograms total) or, if the woman is conscious, misoprostol orally 3 × 200 microgram

tablets.

Section 41: Emergency obstetric procedures: manual removal placenta

- Examine the uterine surface of the placenta to ensure that it is complete. If any placental lobe or tissue is missing, explore the uterine cavity under strict surgical asepsis to remove it.
- Examine the mother carefully and repair any tears to the cervix or vagina, or undertake episiotomy repair.

Problems

If the placenta is retained due to a constriction ring or if hours or days have passed since delivery, it may not be possible to get the entire hand into the uterus. Consider using a general anaesthetic to help to relax the cervix, and extract the placenta in fragments using two fingers or ovum forceps, but be very careful not to penetrate the soft uterine wall. If hours or days have passed and/or signs of sepsis are present, treat for puerperal sepsis with a full course of IV antibiotics (see Section 18).

Post-procedure care

Observe the mother closely until the effect of IV analgesia has worn off.

- Monitor the vital signs (pulse, blood pressure, respiration and temperature) every 15 minutes for the first hour and then every 30 minutes for the next 6 hours or until the patient is stable.
- Palpate the uterine fundus to ensure that the uterus remains contracted.
- Check for excessive lochia.
- Continue infusion of IV fluids.
- Transfuse as necessary, especially if the mother is severely anaemic before the procedure.
- Warn the mother of the increased risk of this occurring at the time of the next pregnancy, and therefore advise her to deliver in a well-equipped comprehensive EmOC facility.

Bilateral pudendal nerve block

This technique is indicated for some instrumental deliveries, for repair of larger tears, and for craniotomy or craniocentesis. The block targets the pudendal nerve as it enters the lesser sciatic foramen, about 1 cm inferior and medial to the attachment of the sacro-spinous ligament to the ischial spine. The aim is to block the nerve proximal to its terminal branches. Here the nerve is medial to the internal pudendal vessels. The transvaginal approach is described here, as it is the most reliable.

The procedure must be undertaken with surgical sterility after cleaning the vagina with chlorhexidine (Hibitane) obstetric cream, and always using sterile gloves.

Dilute 20 mL of 1% lidocaine to 40 mL with Ringer- lactate or Hartmann's solution, to make a solution of 0.5%. This is used starting with 15 mL on each side. The remaining 10 mL can be used to infiltrate the perineum during repairs if these are needed. Adrenaline is not used with the lidocaine. Ensure that IV access is in place. The needle used should be around 15 cm in length and 20–22 gauge.

Procedure

Palpate the ischial spine through the vaginal wall.

A metal trumpet can facilitate the placement of the needle and limit the depth of sub-mucosal penetration, but is not essential.

- 1 To perform a left-sided block, palpate the ischial spine with the index finger of the left hand, hold the syringe in the right hand, and guide the needle between the index finger and middle finger of the left hand toward the ischial spine (see *Figure 41.22*).
- 2 Place the end of the guide beneath the tip of the ischial spine.
- 3 Push the needle into the vaginal mucosa.
- 4 Aspirate to ensure that the needle is not in one of the pudendal blood vessels, which could be very dangerous if lidocaine is injected.
- 5 Inject 1 mL of local anaesthetic.

Figure 41.22 Inserting the needle using a trumpet guide

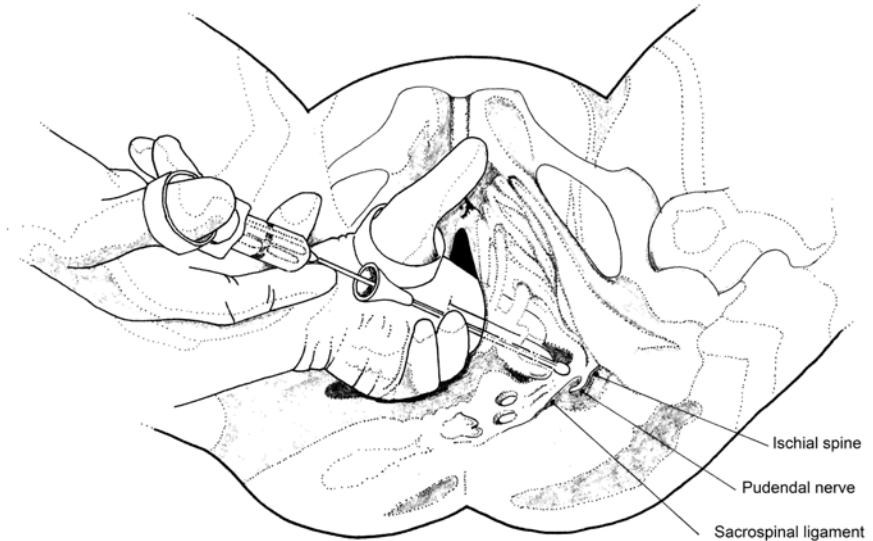

- 6 Advance the needle through the vaginal mucosa until it touches the sacrospinous ligament 1 cm medial and posterior to the ischial spine.
- 7 Aspirate to ensure that the needle is not in one of the pudendal blood vessels, which could be very dangerous if lidocaine is injected, and infiltrate with 3 mL of local anaesthetic.
- 8 Next, advance the needle further through the sacrospinous ligament for a distance of 1 cm until a loss of resistance is detected.
- 9 The tip now lies in the area of the pudendal nerve. At this point, the pudendal vessels lie just lateral to the pudendal nerve, so care must be taken to avoid intravascular administration. Aspirate to confirm that the needle placement is not intravascular prior to injecting lidocaine.
- 10 Inject another 3 mL of local anaesthetic solution into this region.
- 11 Subsequently, withdraw the needle into the guide and move the tip of the guide to just above the ischial spine.
- 12 At this new location, reinsert the needle through the mucosa and again inject 3 mL of local anaesthetic. Aspirate to confirm that the needle placement is not intravascular prior to injecting lidocaine.

To block the right side of the pelvis, repeat these steps using the right hand to hold the needle and needle guide. The block usually takes at least 5 minutes to become effective, and lasts for between 20 and 60 minutes. Check bilaterally for pain before starting the procedure.

A smaller repeat dose (up to 5 mL of 0.5% lidocaine) on each side can be used if an adequate block is not seen.

Section 42: Major trauma in pregnancy

Special issues

The anatomical and physiological changes that occur in pregnancy are important in assessment and resuscitation.

Anatomical changes

- As the uterus increases in size during pregnancy, it becomes more vulnerable to damage by both blunt and penetrating injury. Before 12 weeks of gestation, the bony pelvis protects it, but thereafter it is an abdominal organ. The uterine fundus reaches the umbilicus at 20 weeks, and the xiphisternum at 36 weeks.
- In the first trimester, the fetus is well protected by the thick-walled uterus and relatively large amounts of amniotic fluid. As the pregnancy progresses, the uterine wall becomes thinner, providing less protection for the fetus.
- In late pregnancy, the uterus and its contents shield the maternal abdominal contents, providing a degree of protection for the maternal viscera, at the expense of fetal well-being.

Physiological changes in pregnancy

- increased tidal volume
- blood volume increases by 40% to 100 mL/kg
- basal heart rate increases to 85–90 bpm
- 30% increased cardiac output
- a fall in blood pressure of 5–15 mmHg
- aortocaval compression as the uterus increases in size from 20 weeks' gestation, with the potential for reduced cardiac output
- *upward displacement of the diaphragm as the uterus increases in size, with an impact on lung volume, and predisposition to gastro-oesophageal reflux.*

Special issues in the traumatised pregnant woman or girl

Blunt trauma may lead to:

- haemorrhage from abdominal organs, notably the spleen and liver
- uterine irritability and premature labour
- partial or complete uterine rupture
- partial or complete placental separation (up to 48 hours after trauma)
- fetal death
- fetal distress.

Pelvic fractures may be associated with severe blood loss.

What are the priorities?

- Assessment and resuscitation according to the ABC structured approach.
- Resuscitation in the left lateral position after 20 weeks' gestation, to avoid aorto-caval compression
- Assessment of fundal height and tenderness, and fetal heart rate monitoring as appropriate.
- Vaginal examination or speculum examination to assess vaginal bleeding, cervical dilatation and rupture of membranes.

If placenta praevia is known or suspected, digital vaginal examination should not be performed, as major haemorrhage may occur. Careful speculum examination is important if there is vaginal bleeding post trauma.

It is important to be alert to signs of hypovolaemia, which are delayed in pregnancy as the mother has a higher circulating volume. Hypovolaemia may compromise the fetus before the mother's vital signs become abnormal. A fall in maternal blood pressure is a late and ominous sign.

Resuscitation of the mother may save the baby as well.

There are times when the mother's life is at risk and the fetus may need to be delivered in order to save the mother.

Action plan

Section 42: Major trauma

- 1 Call for the most senior help available.
- 2 Perform standard primary assessment and resuscitation (see below).
- 3 In addition:
 - Assess fetal well being. Use ultrasound examination to detect the fetal heart rate and to identify any retro- placental or intra-abdominal bleeding. Ultrasound is also useful for ascertaining the presentation of the fetus; transverse lie may suggest rupture of the uterus.
 - Consider whether Caesarean section is indicated for maternal or fetal reasons.

Indications for Caesarean section (if facilities are available to perform it safely)

- cardiac arrest
- uterine rupture
- inadequate exposure during laparotomy for other abdominal trauma
- placental abruption
- an unstable pelvic or lumbo-sacral fracture with the patient in labour
- fetal distress with a viable fetus.

Peri-mortem Caesarean section (see Section 8)

This should be undertaken when maternal cardiac output has not been restored by initial cardiopulmonary resuscitation (CPR). Delivery should ideally be accomplished within 5 minutes of cardiac arrest.

The rationale behind peri-mortem Caesarean section is as follows:

- improvement in maternal cardiac output due to relief of aortocaval compression
- improvement in maternal oxygenation
- greater efficacy of CPR due to better access
- better chance of fetal survival if in third trimester.

Peri-mortem Caesarean section should be undertaken with a left lateral tilt of 15–30 degrees, or preferably with manual displacement of the uterus. CPR should continue throughout, until cardiac output is restored. The operation should take place at the scene of cardiac arrest, rather than after moving the patient to the operating theatre, which wastes precious time. Blood loss is minimal until cardiac output resumes. The woman can be moved to the operating theatre once cardiac output is restored. The fetus may survive, but this is a secondary consideration. The aim of peri-mortem Caesarean section is to save the mother's life, as resuscitation is more likely to be effective if the gravid uterus is emptied.

Secondary assessment

Left lateral tilt should be maintained throughout the assessment, in order to minimise aortocaval compression. If spinal injury is suspected, manual displacement of the uterus should be undertaken instead.

Specific types of trauma

Blunt trauma

The three commonest causes are road traffic accidents, falls and intimate partner violence.

Uterine rupture due to blunt trauma is relatively rare. However, blunt trauma to the abdomen may cause placental abruption. Kleihauer testing, if available, is useful for detecting feto–maternal haemorrhage as an indicator of placental damage. Detection of intra-abdominal haemorrhage may be difficult in pregnancy, so early laparotomy should be considered. Remember that the mother may lose a third of her blood volume before the vital signs become abnormal.

Penetrating abdominal wounds

Knife and gunshot wounds are the most common. Penetrating injuries can cause uterine injury at any stage of pregnancy. The uterus, fetus and amniotic fluid reduce injury to the mother by absorbing energy and displacing bowel upwards and to the side. Penetrating injuries above the uterus may cause extensive gastrointestinal and vascular damage. Exploratory laparotomy is

Section 42: Major trauma

usually required in the management of penetrating abdominal wounds, in pregnancy as in the non-pregnant patient.

Thoracic trauma

Injury to major thoracic structures is particularly dangerous in pregnancy, due to the combination of pre-existing relative aorto-caval compression, reduced respiratory excursion and aspiration of gastric contents.

Pathway of care: trauma in pregnancy.

Primary assessment and resuscitation	Airway: increased risk of aspiration – early gastric tube
	Breathing: if chest drain is needed, place at higher level (3rd or 4th intercostal space)
	Circulation: left lateral tilt Abnormalities in pulse rate, blood pressure and capillary refill are late because of hypervolaemia of pregnancy 'Targeted resuscitation' with IV crystalloids, colloid or blood
	Neurological failure: convulsions may be due to eclampsia as well as head injury

Secondary assessment and emergency treatment:

Assess for:

- Ruptured uterus and placental abruption after blunt trauma to abdomen (including seat-belt injury). Uterine tenderness, vaginal bleeding, shock can all occur with both. Ultrasound scan may show fetal death or intra-abdominal fluid (blood)
- Rupture of membranes (by speculum)
- Fetal distress

Evidence of intra-abdominal bleeding or injury to abdominal organs

Consider bowel injury (compressed by uterus and therefore more vulnerable to blunt trauma or penetrating injuries)

Ensure anti-tetanus measures

X-rays as needed

On discharge from hospital, patient to report abdominal pain, decreased fetal movements, vaginal bleeding or fluid leakage

Structured approach to major trauma in pregnancy

If possible a team leader should be in overall charge of resuscitation

Treat the greatest threat to life first

- Primary assessment and resuscitation
- Secondary assessment and emergency treatment
- Definitive care

Primary assessment and resuscitation

- **Airway** and control of haemorrhage (and cervical spine control)
- **Breathing**
- **Circulation** and continued haemorrhage control

During the primary assessment, assess and resuscitate in sequence – Airway + control of haemorrhage, Breathing and Circulation (AcBC) – as these, if compromised, can be an immediate threat to life. Although the patient may have obvious severe injuries, the clinician's first task is to prevent further deterioration of the patient's condition by ensuring that vital organs, especially the

Section 42: Major trauma

heart and the brain, are supplied with oxygenated blood by ensuring an open airway, adequate breathing and circulation.

AVOID: hypoxia, hypercapnia, hypovolaemia, hypoglycaemia and hypothermia

Although AcBC management is described sequentially, if there are sufficient trained clinicians present, they can be managed at the same time. If there are limited personnel, the approach must be Ac then B then C. If there is only one trained person available, make use of untrained staff such as ward orderlies or relatives to perform tasks under your supervision. For example, if there is visible severe exsanguinating haemorrhage, once you have identified and controlled it, the ward orderly can continue to apply the pressure while you open the airway and give oxygen, etc. You will need to continually monitor the untrained person's actions to make sure that they are still effective.

Primary assessment and resuscitation: Ac (with cervical spine control if needed). The first priority is establishment or maintenance of airway opening, and control of any obvious life-threatening haemorrhage.

Stop visible external exsanguinating bleeding, if any, by applying direct pressure. This bleeding will be from a superficial artery or large vein. Minor bleeding can be left until the vital AcBC have been assessed and resuscitated. Internal bleeding will be dealt with first in 'C' by replacing fluid, and then, if necessary, by **emergency surgery**.

LOOK for chest movement

- LISTEN for breath sounds
- FEEL for exhaled air
- **Talk to the patient**

If the patient is conscious, ask them to speak, using the question 'Are you all right?' A patient who can speak must have a clear airway.

If the patient is unconscious, airway obstruction is most commonly due to obstruction by the tongue.

The signs of airway obstruction may include:

- snoring or gurgling
- stridor or abnormal breath sounds
- agitation (hypoxia)
- using the accessory muscles of ventilation/paradoxical chest movements
- cyanosis.

Management of the airway

- Head tilt/chin lift or jaw thrust. Jaw thrust is recommended in trauma, as it does not require any neck movement. However, if a jaw thrust is unsuccessful or the person resuscitating the patient cannot effectively undertake this manoeuvre, try chin lift with some head tilt. **A closed airway will always be potentially fatal, so the airway takes priority.**

- Suction/removal of blood, vomit or a foreign body, if any, but only under direct vision. Do not blindly suck in the mouth or pharynx.

- If there is no improvement, place an oropharyngeal airway. **DO NOT place a nasopharyngeal airway if base of skull injury is suspected.**

- If the airway is still obstructed, a definitive airway by intubation or surgical airway may be needed.

- Identify the 'at-risk' airway:
 - Altered level of consciousness will fail to protect the airway.
 - Vomiting, with risk of aspiration, is a major risk in pregnancy.
 - Facial trauma, including burns, will continue to worsen as the tissues swell.

Once the airway is open, give high-flow oxygen using a mask and reservoir.

If the airway cannot be maintained and/or protected, consider the need for advanced airway management.

Indications for advanced techniques for securing the airway (intubation or surgical airway) include:

Section 42: Major trauma

- persistent airway obstruction
- a conscious level of ≤ 8 on the Glasgow Coma Scale, or 'P' or 'U' on the AVPU scale
- penetrating neck trauma with haematoma (expanding)
- apnoea
- hypoxia
- severe head injury
- chest trauma
- maxillofacial injury.

Intubation techniques should be performed by an experienced anaesthetist.

For intubation, the following sequence should be followed:

- 1 Pre-oxygenation with 100% oxygen, with manual lung inflation if required.
 - 2 Administration of a carefully judged anaesthetic induction agent.
 - 3 Application of cricoid pressure.
 - 4 Suxamethonium 1–2 mg/kg.
 - 5 Intubation with a correctly sized tracheal tube.
- Have a suitably sized bougie available.

Confirmation of correct placement of the endotracheal tube

Signs such as chest movement and auscultation remain helpful, but are occasionally misleading, especially in inexperienced hands. The most reliable evidence is to see the tube pass through the vocal cords. The correct size is a tube that can be placed easily through the cords with only a small leak. Intubation of the right main bronchus is best avoided by carefully placing the tube only 2–3 cm below the cords, and noting the length at the teeth before checking by auscultation, which is best done in the left and right lower axillae. Capnography (if available) is a useful adjunct to help to confirm correct tube placement.

A Seldinger technique for intubating using a bougie may be needed.

Indications for surgical cricothyrotomy

- Inability to open or clear the airway, and the patient is losing consciousness due to cerebral hypoxia (usually also cyanosed and bradycardic).
- Inability to ventilate the lungs despite high-level CPAP via a bag-valve-mask system and 100% oxygen through a reservoir attached to the bag.
- Inability to intubate through the larynx, either because this is not possible or due to lack of experience.

Emergency Surgical airway: Surgical cricothyroidotomy

Only in desperate situation if other methods of airway opening procedures have failed

Call surgeon (ENT) and anaesthetist (if available)

1. Place supine.
2. If no risk of neck injury, consider extending neck to improve access. Otherwise, maintain a neutral alignment.
3. Identify cricothyroid membrane in the following manner. Place your finger over the most prominent part of thyroid cartilage (Adam's apple). Move the finger downwards i.e. towards the chest, keeping strictly in the mid-line. The first dip felt is the area of cricothyroid membrane.
4. Prepare skin and, if patient is conscious, infiltrate with local anaesthetic.

Figure 42.1 Landmarks for surgical cricothyrotomy



Section 42: Major trauma: Surgical cricothyrotomy

- Place index and middle fingers of your left hand on each sides of midline of neck to stabilise cricothyroid membrane, and to protect lateral vascular structures from injury.
- Make a small vertical incision in skin, and with the index and the middle fingers of the left hand, press lateral edges of incision outwards, to minimise bleeding.
- Make a transverse incision through cricothyroid membrane, being careful not to damage cricoid cartilage.
- Insert a tracheal spreader to open airway.
- Insert an appropriately sized endotracheal or tracheostomy tube. It is advisable to use a slightly smaller size than would have been used for oral intubation
- Ventilate patient and check that this is effective – if not and if large air leak after inflating cuff may need to change tube for a size bigger.
- Secure tube to prevent dislodgement.

Complications

- Asphyxia: Aspiration of blood or secretions: Haemorrhage or haematoma.
- Creation of a false passage into tissues: Surgical emphysema (subcutaneous or mediastinal).
- Pulmonary barotrauma
- Subglottic oedema or stenosis
- Oesophageal perforation.
- Infection.

Cervical spine protection

Protect the cervical spine with collar, sand bags and tape if the patient is likely to have an unstable cervical spine. It is important to recognise that although protection of the cervical spine may occasionally be beneficial, **the opening and maintaining of a clear airway is an absolute priority.**

Cervical spine immobilisation

All patients with major trauma should have full spinal stabilisation if feasible from the moment of injury, and should be treated as if they have a cervical spine injury until proven otherwise.

The cervical spine can be mobilised in three ways:

- 1 In-line stabilisation: the spine is held in the neutral position by the clinician's hands on either side of the patient's head, ensuring that the ears are not covered, as the patient must be able to hear to be reassured and informed. This position must be held until the collar and/ or blocks are in place.
- 2 A cervical collar can be placed around the neck. Before placing the collar, gently feel around the back of the patient's neck to ascertain if there is any midline tenderness and/or a 'step' indicating a fracture or if there is any bleeding. The collar is used by itself in the combative patient, and in conjunction with blocks or sandbags in the unconscious or cooperative patient (i.e. one who will remain still).
- 3 Sandbags or blocks and tape are usually added after the collar has been fitted. They cannot be used in combative patients as their movements to free themselves will cause more injury. They are essential in the unconscious patient who has a possibility of neck injury. These objects are placed on either side of the patient's head to prevent lateral movement, and held in place with two tapes, one across the patient's forehead and the other across the chin part of the cervical collar.

Cervical spine immobilisation

Exceptions

Two groups of patients may prove to be difficult:

- the frightened uncooperative patient (most common)
- the hypoxic combative patient.

In both of these cases, over-enthusiastic efforts to immobilise the neck may increase the risk of spinal injury as the patient struggles to escape. The area of greatest mobility in the cervical spine is the C7/T1 junction, and this is at increased risk in the combative patient

Figure 42.2 Immobilisation of the cervical spine using head blocks and straps with a cervical collar in place.

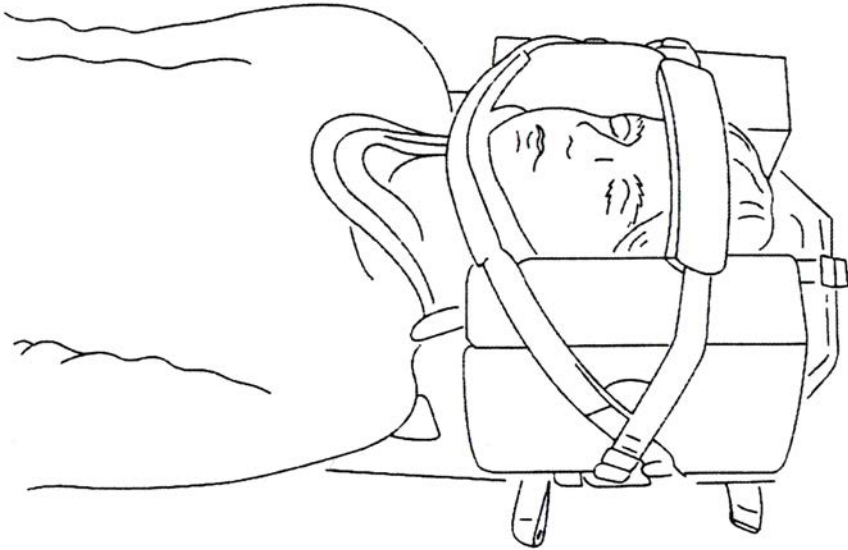

Primary assessment and resuscitation: breathing

After management of the airway, the patient's breathing should be assessed. The same approach is adopted as for the patient suffering a serious illness.

Assessment of breathing

- Effort: recession, rate, added noises, accessory muscles, alar nasal flaring.
- Efficacy: breath sounds, chest expansion, abdominal excursion.
- Adequacy: heart rate, skin colour (look for cyanosis), mental status.
- A pulse oximeter is very useful to monitor oxygenation adequacy (SaO₂).

Unequal breath sounds or poor oxygenation:

- Pneumothorax or haemothorax.
- Misplaced or blocked endotracheal tube.

Looking at the respiratory rate and chest expansion is essential. In addition to the signs listed above, check whether any of the following are present:

- penetrating injury
- presence of flail chest
- sucking chest wounds.

Listen for breath sound character and equality:

- pneumothorax or haemothorax (decreased breath sounds on site of injury)
- detection of abnormal sounds in the chest.

Feel for:

- tracheal shift (sign of tension pneumothorax on side away from the deviation)
- broken ribs
- subcutaneous emphysema.

Percuss for:

- useful in diagnosis of haemothorax (dull on affected side) and pneumothorax (hyper-resonant on affected side).

Section 42: Major trauma: needle thoracocentesis and chest drain

Continue giving high-flow oxygen (up to 15 litres/minute) in all cases.

Careful examination of the trachea, neck veins and chest may indicate the presence of pleural collections of air or blood.

Tension pneumothorax should be treated immediately with needle thoracocentesis in the second intercostal space in the mid-clavicular line (see below).

Assisted ventilation

Provide assisted ventilation if needed to patients with breathing problems, using a bag and mask with a reservoir attached, or by intubation and intermittent positive pressure ventilation. Do not persist with intubation attempts without oxygenating the patient.

Look for and treat the following:

- airway obstruction (see above)
- tension pneumothorax
- open pneumothorax
- haemothorax
- flail chest
- cardiac tamponade. See below for details.

TABLE 42.1 Serious chest trauma: signs and treatment (see later for more details)

Breathing problem	Clinical signs	Treatment
Tension pneumothorax	<ul style="list-style-type: none">• Decreased air entry on side of pneumothorax• Decreased chest movement on side of pneumothorax• Hyper-resonance to percussion on side of pneumothorax• Tracheal deviation away from side of pneumothorax• Hypoxic shocked patient• Full neck veins	High-flow oxygen Needle thoracocentesis (Figure 42.3) Chest drain insertion (Figure 42.4)
Open pneumothorax	<ul style="list-style-type: none">• Penetrating chest wound with signs of pneumothorax• Sucking or blowing chest wound	High-flow oxygen Chest drain Wound occlusion on three sides

Section 42: Major trauma: needle thoracocentesis and chest drain

<p>Massive haemothorax: blood in pleural space</p>	<ul style="list-style-type: none"> • Decreased chest movement on side of haemorrhage • Decreased air entry on side of haemorrhage • Dullness to percussion on side of haemorrhage • Shock and hypoxia • Collapsed neck veins 	<p>High-flow oxygen</p> <p>Venous access and IV volume replacement</p> <p>Chest drain (a haemothorax of 500–1500 mL that stops bleeding after insertion of an intercostal catheter can generally be treated by closed drainage alone; a haemothorax of >1500–2000 mL, or with continued bleeding of more than 200–300 mL/hour, may be an indication for further investigation, such as thoracotomy)</p>
<p>Flail chest: paradoxical movement of a chest wall segment associated with underlying lung contusion</p>	<ul style="list-style-type: none"> • Decreased efficiency of breathing 	<p>Oxygen and pain relief</p> <p>May need intubation and ventilation</p> <p>Transfer if feasible</p>
<p>Cardiac tamponade: blood in pericardial sac causing a decrease in cardiac output</p>	<ul style="list-style-type: none"> • Shock associated with penetrating or blunt chest trauma • Faint apex beat and/or muffled heart sounds • Distended neck veins 	<p>Oxygen</p> <p>IV access and IV fluids</p> <p>Emergency needle pericardiocentesis (see Figure 42.5)</p>

Needle thoracocentesis

This procedure is used for the rapidly deteriorating patient who has a life-threatening tension pneumothorax. If it is used with a patient who does not have a tension pneumothorax, there is a 10–20% risk of producing a pneumothorax or causing damage to the lung, or both. In such cases immediate subsequent insertion of a chest drain is mandatory.

A confirmatory Chest X-Ray is not required or appropriate. It should be followed by chest drain placement if tension is seen to be relieved.

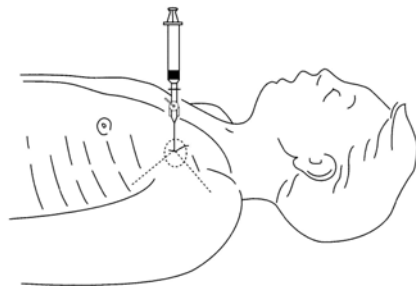

Figure 42.3 Needle thoracocentesis

- 1 Identify the second intercostal space in the mid-clavicular line on the side of the pneumothorax (the opposite side to the direction of tracheal deviation, and the same side as the hyper-resonance).
- 2 Swab the chest wall with surgical prep or an alcohol swab.
- 3 Attach the syringe to the over-needle venous cannula.
- 4 Insert the cannula into the chest wall, just above the rib below, aspirating all the time.

Section 42: Major trauma: needle thoracocentesis and chest drain

5 If air is aspirated, remove the needle, leaving the plastic cannula in place. Alternatively, insert the over-needle venous cannula without a syringe and note a 'hiss' of air on relief of the tension pneumothorax when the metal stylet is removed from the plastic cannula.

6 Tape the open cannula in place and proceed to chest drain insertion as soon as possible.

Complications of needle thoracocentesis

- Local cellulitis.
- Local haematoma.
- Pleural infection.
- Empyema.
- Pneumothorax.

Insertion of a chest drainage tube

In a trauma emergency that requires a chest drainage tube, fluid resuscitation through at least one large calibre IV cannula, and monitoring of vital signs should be on going. Usually the patient will be receiving oxygen through a facemask with a reservoir.

Chest drain placement should be performed using the open technique described here, as this minimises lung damage. In general, the largest size of drain that will pass between the ribs should be used.

Minimum equipment

- Skin disinfectant and surgical drapes.
- Scalpel with fine straight blade.
- Blunt forceps.
- Artery forceps.
- Large clamps × 2.
- Suture.
- Local anaesthetic if the patient is conscious.
- Scissors.
- Chest drain tube.
- Underwater seal or Heimlich flutter valve.

Figure 42.4 Sites for chest drain: 4th or 5th intercostal space in the anterior or mid-axillary line (see picture below) but in pregnancy after 20 weeks gestation use 3rd and 4th intercostal spaces.

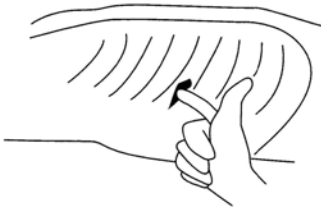

Procedure

- 1 Consider using analgesia or sedation.
- 2 Wash your hands and arms to the elbows, and wear a mask, surgical hat (bonnet), sterile gown and sterile surgical gloves.
- 3 Prepare the underwater seal with an assistant and take the sterile end of the tube, ready to connect to the chest tube once inserted. The 'seal' end should be covered by no more than 1–2 cmH₂O.
- 4 Decide on the insertion site (usually the fourth or fifth OR in pregnancy after 20 weeks third or fourth intercostal space in the anterior or mid-axillary line) on the side with the pneumothorax (see Figure 42.4).

- 5 Swab the chest wall with surgical preparation or an alcohol swab.
6 Use local anaesthetic if the patient is conscious.

Section 42: Major trauma: needle thoracocentesis and chest drain

7 Make a 2- to 3-cm skin incision along the line of the intercostal space, immediately above the rib below to avoid damage to the neurovascular bundle that lies under the inferior edge of each rib.

8 Using artery forceps, bluntly dissect through the subcutaneous tissues just over the top of the rib below, and puncture the parietal pleura with the tip of the forceps.

9 Put a gloved finger into the incision and clear the path into the pleura.

10 Advance the chest drain tube (use the largest size that can comfortably pass between the ribs) into the pleural space without the trocar in place, but using the artery forceps to help to guide it into the pleural cavity if necessary. Pass about 3 cm and then connect to the underwater seal. Ideally advance the chest drain tube into the pleural space during expiration.

11 Ensure that the tube is in the pleural space by looking for fogging of the tube during expiration.

12 Ensure that all of the drainage holes of the chest drain tube are inside the chest.

13 Connect the chest drain tube to an underwater seal. Check that the tube is in the right place by observing intermittent bubbling of the water in the drainage bottle.

14 Secure the tube using a suture passed through the skin at the incision site (after ensuring that adequate local anaesthetic has been administered) and tied around the tube.

15 Cover the puncture site in the chest wall with a sterile dressing, and tape the chest tube to the chest wall.

16 Obtain a chest radiograph if at all possible.

If the chest drainage tube is satisfactorily positioned and working, occasional bubbles will pass through the underwater seal. The water level in the tube will also rise and fall slightly with the respiratory cycle.

Complications of chest drainage tube insertion

- Dislodgement of the chest drain tube from the chest wall or disconnection from the drainage bag.
- Drainage bag elevated above the level of the chest, and fluid flowing into the chest cavity, unless there is a one-way valve system.
- Chest drain tube kinking or blocking with blood clot.
- Damage to the intercostal nerve, artery or vein. This might convert a pneumothorax to a haemopneumothorax, or result in intercostal neuritis or neuralgia.
- Damage to the internal thoracic artery if the puncture is too medial, resulting in haemopneumothorax.
- In-correct tube position, inside or outside the chest cavity.
- Introduction of pleural infection (e.g. thoracic empyema)
- Laceration or puncture of intrathoracic or abdominal organs which can be prevented by using the finger technique before inserting the chest tube
- Leaking drainage bag
- Local cellulitis
- Local haematoma
- Mediastinal emphysema
- Persistent pneumothorax from a large primary defect; a second chest tube may be required.
- Subcutaneous emphysema (usually at the tube insertion site)

Primary assessment and resuscitation: circulation

Assessment of circulation

Circulatory assessment includes identification of actual and potential sources of blood loss.

Closed fractures and bleeding into the chest, abdomen or pelvis may make it difficult to detect how much blood has been lost. The ability to estimate the percentage blood loss is helpful when planning resuscitation. Remember that blood volume in pregnancy is 100 mL/kg, or 5–7 litres.

TABLE 42.2 Blood loss in pregnancy

Sign	Percentage circulating blood loss		
	<25	25–40	>40
Heart rate	slight increase	moderate increase	marked increase or bradycardia
Systolic BP	normal	normal	beginning to fall
Pulse volume	normal or decreased	seriously decreased	very seriously decreased
Skin	cool, pale, sweaty, CRT	cool, mottled, sweaty CRT	cool and sweaty CRT
Respiratory rate	slight increase	moderate increase	sighing respirations
Mental status	slight agitation	lethargic or uncooperative	only reacts to pain

* CRT Capillary refill time > 3 seconds.

Note that blood pressure may be normal until up to 50% of the patient’s circulatory volume has been lost. The blood pressure is initially well maintained despite continuing bleeding in pregnancy. As an indicator of haemorrhage, it can be falsely reassuring. A progressively worsening tachycardia is more relevant. A monitoring device which displays measurements of pulse rate, ECG trace and blood pressure is useful if available.

Resuscitation of circulation

Management is focused on avoiding hypovolaemia and controlling blood loss. Loss of blood is the most common cause of shock in major trauma.

Concealed bleeding severe enough to cause shock can occur into the pleural cavity, abdomen, pelvis and femur

Stop bleeding

The first priority is to stop obvious bleeding by applying direct pressure. Do not forget that the patient may have a wound on their back that is bleeding into the bed. To examine the back, the patient should be log-rolled, if indicated.

- Injuries to the limbs: tourniquets do not work well and may cause reperfusion syndromes and add to the primary injury. The recommended procedure is the application of a ‘pressure dressing’. Severe bleeding from high-energy penetrating injuries and amputation wounds can be controlled by sub-facial gauze pack placement, plus manual compression on the proximal artery, plus a carefully applied compressive dressing of the entire injured limb.
- Injuries to the chest: the most common source of bleeding is chest wall arteries. Immediate placement of a chest tube drain plus intermittent suction of the tube plus efficient analgesia (IV ketamine is the drug of choice, if available) expand the lung and seal off the bleeding.

Tranexamic acid This can reduce mortality from major haemorrhage in major trauma in pregnancy. This drug should be started as soon as possible, and within the first 3 hours after the trauma, to be effective.

The loading dose in pregnancy is 1 gram over 10 minutes followed by an IV infusion of a further 1 gram over 8 hours.

Section 42: Major trauma

The slow IV bolus dose is given by injecting 1 gram of tranexamic acid into a 100-mL bag of 0.9% saline and letting it run through over about 10–20 minutes (the exact timing is not crucial). The 8-hour infusion is given by injecting 1 gram of tranexamic acid into a 500-mL bag of 0.9% saline and giving it over 8 hours (approximately 60 mL/hour). If there is a gap between the initial bolus and the subsequent infusion this probably does not matter too much, but ideally one should follow the other.

Elevate the legs if the patient is in shock.

IV fluid resuscitation

The goal is to restore oxygen delivery to the tissues. As the usual problem is loss of blood, fluid resuscitation (of blood as soon as possible) must be a priority.

- Adequate vascular access must be obtained. This requires the insertion of at least one, and ideally two, large-bore cannula (14–16 G). Peripheral cut-down or intra-osseous infusion may be necessary.
- Infusion fluids: These should be warmed to body temperature. Remember that hypothermia can lead to abnormal blood clotting. Use crystalloids such as Ringer-lactate or Hartmann's solution whilst awaiting blood for transfusion. Normal (0.9%) saline can be used if these fluids are unavailable, but be aware that, especially in larger volumes, normal saline causes a hyperchloraemic acidosis which is detrimental to sick or injured patients.)
- Do not give hypotonic solutions (e.g. 5% Dextrose in water or 5% Dextrose with 1/5N saline, these are dangerous in this situation) but glucose can be added to Ringer-lactate, Hartmann's or N saline if there is evidence of or concern about hypoglycaemia.
- Take blood for Hb, group and cross match and glucose, electrolytes and amylase for urgent analysis.

Not all cases of hypovolaemia require aggressive fluid therapy. In adults, withholding fluids in penetrating trunk trauma before achieving surgical haemostasis has been associated with an improved outcome. The rationale is to avoid pushing up the blood pressure, which hinders clot formation and promotes further bleeding. Aggressive crystalloid fluid replacement can lead to increased fluid requirements, hypothermia, dilution of clotting factors, excessive blood transfusion and its associated immunosuppression. Aim to give sufficient fluid to maintain vital organ perfusion. This can be monitored by monitoring the patient's state of alertness that is a measure of brain perfusion in the absence of a head injury.

On the other hand, in severe head injury, cerebral perfusion is critically dependent on maintaining blood pressure. If the patient has both a severe head injury and major trunk bleeding, the apparently conflicting requirements are best managed by maintaining priorities in AcBC order and achieving prompt surgical haemostasis. Beyond this strategic conflict, it should be remembered that hypovolaemia mimics head injury, and blood pressure itself is a poor indicator of organ perfusion.

As outlined above, the concept of *'targeted fluid resuscitation'* is important if the cause of hypovolaemic shock is haemorrhage from penetrating injury. Here the initial boluses of IV crystalloids required to treat shock should only be given to keep the vital organs (especially the brain, heart and kidneys) perfused before **emergency surgery and blood transfusion** is available. Fresh blood is particularly useful to combat the coagulopathy that occurs in major blood loss if specific coagulation components such as platelets are unavailable.

However, it must be borne in mind that penetrating trauma is not common in women in civilian life. We suggest that when giving boluses of crystalloid or blood to patients in shock due to bleeding in major trauma, only the amount needed to keep the blood pressure at a level sufficient to perfuse the vital organs should be given. There is no clear evidence to indicate the precise blood pressure that should be achieved in a pregnant woman in shock due to haemorrhage. Adequate perfusion of vital organs may best be indicated by a radial pulse which can be palpated and an alert conscious level (in the patient without a significant head injury). The adequacy of the fetal heart rate may also be helpful.

Section 42: Major trauma

Therefore to maintain a palpable radial pulse in pregnancy, start with IV boluses of 500 mL of crystalloid or ideally blood, and reassess after each bolus.

After repeating boluses twice (i.e. 500 mL twice in pregnancy), the transfusion of blood (packed red cells) should if possible be urgently achieved. The most important aspect of fluid resuscitation is the patient's response to the IV fluid challenge. Improvement is indicated by the following:

- a decrease in heart rate
- an increase in systolic blood pressure
- an increase in skin temperature
- faster capillary refill
- improving mental state.

Failure to improve should prompt an urgent search for chest, abdominal or pelvic haemorrhage, with the immediate involvement of an experienced surgeon. Similar volumes may be repeated if there is continuing evidence of haemorrhagic shock, after re-evaluating the state of the circulation.

It is useful to delegate the initial fluid bolus to a member of the trauma team (if a team is available), who attaches the warmed fluid bag to the IV cannula via a three-way tap to which is attached a 20- or 50-mL syringe to give the boluses.

Blood transfusion

There may be considerable difficulty in getting blood. Remember possible incompatibility, and hepatitis B and HIV risks; even among the patient's own family. Blood transfusion must be considered when the patient has persistent haemodynamic instability despite fluid (colloid/crystalloid) infusion. If the type-specific or cross- matched blood is not available, type O negative packed red blood cells should be used. Transfusion should be seriously considered if the haemoglobin level is less than 7 grams/ dL and if the patient is still bleeding. Blood transfusion is most important, and requires blood to be taken for urgent cross matching. As described above, early surgical involvement is essential.

Vascular access

This is essential in all seriously injured patients. A minimum of two relatively large-bore IV cannula is essential.

TABLE 42.3 *Infusion IV line flow rates*

Colour code	Gauge	Crystalloid flow rate (mL/minute)
Brown	14	240
Grey	16	172
Yellow	17	130
Green	18	76
Pink	20	54
Blue	22	25
Lime green	24	14

Peripheral veins are preferable; the inexperienced should not attempt central venous cannulation. The external jugular vein can be accessed even in shock, but the cannula can become easily displaced and must be very carefully taped in place. A cut-down on to the long saphenous vein at the ankle can also be used.

Section 42: Major trauma

If venous access is difficult and is taking too long, the new intra-osseous EZ-IO drill is simple to operate and can be life-saving (see Section 9), and should be available in all emergency departments.

Central venous cannulation can permit large volumes to be rapidly infused and also permit central venous pressure measurements. It must be undertaken by a skilled person (e.g. an anaesthetist), and a Seldinger technique should be used. The femoral vein is not used in pregnant women where instead the internal jugular or subclavian vein may be used. Peripheral venous access can often be established once peripheral perfusion has been improved.

Both femoral venous and tibial intra-osseous access are best avoided if there is clinical evidence of a pelvic or abdominal injury. In such cases it is better to secure vascular access above the diaphragm. The upper outer aspect of the humerus can be used for intra-osseous access in that case (see Section 9). Blood from a vein or bone marrow should be drawn for typing and cross-matching, haemoglobin, glucose and electrolytes. These tests are clinically accurate on a marrow sample from an intra-osseous approach provided there has not been prior infusion of blood or crystalloid fluid.

The infused fluids and blood should be warm. Physiological coagulation works best at normothermia, and haemostasis is difficult at core temperatures below 35°C. Hypothermia in trauma patients is common during protracted improvised outdoor evacuations, even in the tropics. It is easy to cool a patient but difficult to rewarm them, so prevention of hypothermia is essential. IV fluids should have a temperature of 40–42°C (using IV fluids at 'room temperature' means cooling!).

Venous cut-down (see Section 9)

External jugular venous cannulation (see Section 9)

Other less common causes of shock in major trauma

Cardiogenic shock

Inadequate heart function may result from:

- myocardial contusion (bruising)
- cardiac tamponade
- tension pneumothorax (preventing blood from returning to the heart)
- myocardial infarction.

Assessment of the jugular venous pressure is valuable in these circumstances. It will be elevated compared with hypovolaemic shock, where it may not be visible. An ECG should be recorded (if available).

Neurogenic shock

This is due to the loss of sympathetic tone, usually resulting from spinal cord injury, with the classical presentation of hypotension without reflex tachycardia or skin vasoconstriction.

Tension pneumothorax

See under breathing section above. This can present with shock as well as breathing impairment.

Cardiac tamponade (see below)

Summary: managing the circulation in major trauma.

- Direct pressure on bleeding sites
- Consider urgent surgical intervention
- Peripheral, intra-osseous access, central venous or saphenous vein cut-down (see Section 9)
- Elevate the legs
- Fluid resuscitation if shocked
- Monitor response and only continue with fluids if needed

Section 42: Major trauma

- Do not give excess fluids, especially to patients with head or chest injuries, or malnutrition
- Consider the need for surgical intervention

The most important aspect of fluid resuscitation is the response to a fluid challenge.

Improvement is indicated by

- Decreased heart rate
- Increased skin temperature
- Faster capillary refill
- Improved mental state
- Increased systolic blood pressure
- Improved urinary output

If the patient fails to improve, look for chest, abdominal or pelvic blood loss and consider surgical intervention

- Tension pneumothorax needs emergency thoracocentesis and insertion of chest drain(s)
- Exsanguination needs large fluid boluses and blood transfusion
- Pericardial tamponade needs pericardiocentesis

If possible take blood/bone marrow for:

- Cross-matching
- Haemoglobin and full blood count
- Glucose
- Electrolytes

Primary assessment: neurological failure

Head injury is the major cause of death in trauma.

Rapid assessment using the AVPU score:

AVPU score: A = Alert, V = responds to a Voice, P = response to Pain, U = Unresponsive.

- With a score of 'P' or 'U', intubation should be considered in order to maintain and protect the airway. If there is no one skilled in intubation available, the patient should be placed in the recovery position.
- Remember to check for a pain response above the level of the clavicle, as a patient with a spinal injury may not be able to respond by moving their limbs.
- Look for signs indicative of injury (e.g. bruises, lacerations or haematoma) in the head and neck area.
- Examine the pupils for size, equality and reaction to light. Look for other lateralising signs, such as limb weakness or focal seizures.

At this stage, the brain is best cared for by close attention to managing Ac B and C, and by correction of any hypoglycaemia (unusual).

If there is evidence of raised intracranial pressure (RICP):

- Intubate and ventilate to maintain oxygenation, and aim for paCO_2 of about 4 kPa.
- Maintain systolic blood pressure.
- Nurse the patient in a 30-degree head-up position.
- Contact a neurosurgeon (if available).

Give 20 grams of 20% mannitol over 15 minutes as soon as cerebral oedema is suspected.

Repeat every 4–6 hours. Where possible first exclude any intracranial haematoma. If this is not excluded, there will be temporary improvement due to relief of cerebral oedema, but there may be sudden worsening a short time later due to rapid expansion of the haematoma. An alternative is hypertonic saline (2.7% or 3% at 3mL/Kg) which is less likely to result in rebound brain swelling and unlike mannitol does not induce a diuresis.

Always check the blood glucose level where possible.

Analgesia in major trauma (see Section 5)

Section 42: Major trauma

Pain increases fear and distress, makes the patient less able to cooperate, and raises intracranial pressure. If the patient is fully conscious and in severe pain, control of pain is required.

Pain relief takes several different forms:

- Reassurance.
- Splinting of fractures.
- Covering wounds, especially burns.
- Drugs:
 - There is no place for oral or IM medication in a major trauma situation.
 - There are three alternatives in severe trauma: ketamine, morphine and Entonox.

Ketamine

The positive inotropic effects of ketamine, and the fact that it does not affect the gag reflex, make this a helpful analgesic, especially if there is or has been shock. Repeated IV doses of 250 micrograms/kg followed by careful reassessment are usually effective.

Morphine

In major trauma 5–10 mg in pregnancy is the drug of choice, followed by careful reassessment. If the conscious level falls, the effect can be reversed with naloxone, showing whether the effect is caused by the morphine or by a worsening brain injury. If there is respiratory depression, first ventilate with a bag-valve-mask before giving naloxone. A head injury is NOT a contraindication to giving morphine unless there is depressed consciousness, when great care is needed.

Entonox

Entonox (a 50:50 mixture of nitrous oxide and oxygen) is useful, especially for limb injuries while splints are being applied. Do not use it in the presence of head, chest or abdominal trauma.

Regional nerve blocks

Valuable if the necessary skills are available

Summary of primary assessment and resuscitation

The injured patients should have:

- a team approach with an urgent call for surgical and anaesthetic availability
- if external haemorrhage is present this must be stopped
- identification of the need for life-saving surgery and preparation underway
- a clear airway and 100% oxygen for breathing
- cervical spine immobilisation, where appropriate
- adequate respiration, achieved by manual or mechanical ventilation and chest decompression when indicated
- venous access and an initial fluid challenge, if indicated on circulatory assessment
- blood sent for typing and cross-matching and transfused as soon as possible if bleeding
- identification of any serious head injury, and attention paid to maximising A, B and C

Life threatening injuries identified and treated

<i>Injury</i>	<i>Treatment</i>
Airway obstruction	Head tilt, chin lift and jaw thrust, oropharyngeal airway, intubation or surgical airway
Tension pneumothorax	Needle thoracocentesis and chest drain
Open pneumothorax	Three-sided dressing, then chest drain
Massive haemothorax	IV access, chest drain and blood transfusion
Flail chest	Intubation if needed
Cardiac tamponade	Pericardiocentesis

Section 42: Major trauma

Before the secondary assessment begins, it should be remembered that:

ABC and neurological failure components of the primary assessment and resuscitation require constant re-evaluation, as deterioration can be rapid and unexpected.

Emergency operative treatment to control life-threatening haemorrhage should be performed promptly, without waiting for non-urgent examination and imaging.

Identification of all anatomical injuries remains an important goal, but may be overridden by pressing physiological requirements to ensure that oxygenated blood reaches vital organs in sufficient degree. This may require emergency surgery before all non-life-threatening injuries have been identified.

Secondary assessment and emergency treatment

Secondary assessment and emergency treatment are undertaken only when the patient's AcBC's are stable. If any deterioration occurs during this phase, secondary assessment must be interrupted by another primary assessment and resuscitation.

Documentation is required for all procedures undertaken. This involves careful examination from head to toe in a systematic way, including a controlled examination of the back, avoiding spinal movement by log-rolling (see below). Clear documentation of all injuries is required, to serve as the basis of the subsequent management strategy.

History

- Events before and after incident
- First aid given at scene
- Past medical history
- Medications and allergies
- Immunisation status
- Last food and drink

Adjuncts that can help with protecting the patient and monitoring progress.

Secondary assessment: adjuncts

- Monitoring ECG, SaO₂ and blood pressure
- Urinary and gastric catheters
- Portable X-rays of chest and pelvis
- Ultrasound of abdomen (if available)
- Baseline blood tests (especially haemoglobin, cross-matching, biochemistry and clotting)

Head examination

This includes the following:

- scalp and ocular abnormalities
- external ear and tympanic membrane
- periorbital soft-tissue injuries.

Head injury patients should be suspected of having cervical spine injury.

Neck examination

- for a penetrating wound
- for subcutaneous emphysema
- for tracheal deviation
- for neck vein appearance (JVP).

Neurological examination

- brain function assessment using the AVPU Scale or the Glasgow Coma Scale (GCS)
- spinal cord motor activity
- sensation and reflex.

Chest examination

- the clavicles and all ribs
- breath sounds, heart sounds, percussion and tracheal position
- ECG monitoring (if available).

Abdominal examination

- for a penetrating wound of the abdomen requiring surgical exploration

Section 42: Major trauma

- for blunt trauma, for bowel sounds, for tenderness, guarding and rigidity
- rectal examination

Examination of pelvis and limbs

- pain, tenderness on palpation
- deformity
- wounds.

X-rays (if possible and where indicated)

- chest X-ray and cervical spine films (it is important to see all 7 vertebrae)
- pelvic and long bone X-rays
- skull X-rays for fractures when head injury is present
- CT scans of the head and abdomen (if available).

Head injury

The scalp and face are examined for bruising, abrasions, lacerations and evidence of fracture. Basal skull fracture is manifested by signs such as:

- 'raccoon eyes' (bilateral periorbital haematoma), bleeding from the ears or a visible haemotympanum
- Battle's sign (bruising over the mastoid process, which is a relatively late sign)
- CSF leakage from the nose, mouth or ears.

The AVPU Scale score or the Glasgow Coma Scale score is again evaluated, allowing a comparison with the primary assessment estimation (unless the patient is now intubated and sedated).

Delay in the early assessment of head-injured patients can have devastating consequences in terms of survival and patient outcome. Hypoxia and hypotension double the mortality of head-injured patients.

The following conditions are potentially life-threatening but difficult to treat in district hospitals. It is important to treat what you can with the expertise and resources that you have available, and to triage casualties carefully.

Immediate recognition and early management of the following conditions are essential:

Acute extradural haemorrhage

Classical signs consist of:

- loss of consciousness following a lucid interval, with rapid deterioration
- a rapid rise in intracranial pressure, due to bleeding from the middle meningeal artery
- development of hemiparesis on the opposite side, with a fixed pupil on the same side as the impact area.

The management is surgical, and every effort should be made to do burr-hole decompression.

Acute subdural haematoma

There is bleeding in the subdural space, accompanied by severe contusion of the underlying brain. This condition results from tearing of bridging veins between the cortex and the dura. Again, surgery is needed, but it requires a neurosurgeon, not burr-holes alone.

The following conditions should be treated with more conservative medical management, as neurosurgery does not usually improve the outcome:

- base-of-skull fractures
- cerebral concussion, with temporarily altered consciousness
- depressed skull fracture: an impaction of fragmented skull may result in penetration of the underlying dura and brain
- intracerebral haematoma, which may result from acute injury or progressive damage secondary to contusion
- diffuse brain swelling is managed medically, but apart from ventilation and general supportive therapy, recovery is dependent on the severity of the injury and the effect of the initial physiological support of ABC.

Alteration of consciousness is the hallmark of brain injury.

The most common errors in head injury evaluation and resuscitation are:

- failure to perform ABC and prioritise management

Section 42: Major trauma

- failure to look beyond the obvious head injury
- failure to assess the baseline neurological examination
- failure to re-evaluate the patient who deteriorates.

Management of head trauma

The Airway, Breathing and Circulation are stabilised (and the cervical spine immobilised, if possible).

Vital signs are important indicators of the patient's neurological status, and must be monitored and recorded frequently.

The Glasgow Coma Scale (GCS) score is interpreted as follows:

- severe head injury: GCS score is ≤ 8
- moderate head injury: GCS score is 9–12
- minor head injury: GCS score is 13–15.

Remember:

- Deterioration may occur due to bleeding or brain swelling.
- Unequal or dilated pupils may reflect an increase in intracranial pressure.
- Head or brain injury is never the cause of hypotension in the adult trauma patient.
- Sedation should be avoided, as it decreases the level of consciousness, and promotes hypercarbia due to slow breathing with retention of CO_2 .
- The Cushing response is a late sign, reflecting a lethal rise in intracranial pressure, associated with a poor prognosis. The hallmarks are:
 - bradycardia
 - hypertension
 - decreased and erratic respiration.

Basic medical management for severe head injuries includes:

- Intubation and ventilation, producing normocapnia (pCO_2 in the range 4.5–5 kPa, if it is possible to monitor this). This will reduce both intracranial blood volume and intracranial pressure temporarily.
- Sedation with possible paralysis provided that the airway is fully protected by intubation and a means of assisted ventilation present.
- Moderate IV fluid input: do not overload.
- Nursing head up at an angle of 20 degrees.
- Prevention and treatment of hyperthermia/fever.
- Avoidance of hypoglycaemia and electrolyte abnormalities.

Chest trauma

Immediate deaths are usually due to major disruption of the heart or of the great vessels. Early deaths due to chest trauma include airway obstruction, tension pneumothorax, cardiac tamponade or aspiration. The majority of patients with thoracic trauma can be managed by simple manoeuvres and do not require surgical treatment.

Respiratory distress may be caused by:

- rib fractures/flail chest
- pneumothorax
- tension pneumothorax
- haemothorax
- pulmonary contusion (bruising)
- open pneumothorax
- aspiration.

Haemorrhagic shock may be due to:

- haemothorax
- haemomediastinum.

Thorough re-examination of the chest front and back, using the classical inspection–palpation–percussion–auscultation approach, is combined with a chest X-ray.

- Particular attention is directed to the symmetry of chest movement and breath sounds, the presence of surgical emphysema and pain.

Section 42: Major trauma

- Tracheal deviation and altered heart sounds are noted.
- On log-rolling the patient, it is important to reconsider flail chest, as a posterior floating segment is often poorly tolerated.

Rib fractures

Fractured ribs may occur at the point of impact, and damage to the underlying lung may produce lung bruising or puncture. The ribs usually become fairly stable within 10 days to 2 weeks. Firm healing with callus formation is seen after about 6 weeks.

Flail chest

The unstable segment moves separately and in an opposite direction from the rest of the thoracic cage during the respiration cycle. Severe respiratory distress may ensue. Treatment is by analgesia, as breathing is painful, and shallow breathing may predispose to pneumonia in this situation. In severe cases, ventilation is needed.

Pneumothorax

- A tension pneumothorax develops when air enters the pleural space but cannot leave, increasing the compression of the underlying lung with each breath. The consequence is progressively increasing intra-thoracic pressure in the affected side, resulting in mediastinal shift. The trachea may be displaced (late sign) and is pushed away from the midline by the air under tension. The patient will become short of breath and hypoxic. Urgent needle decompression (thoracocentesis) is required prior to the insertion of a chest drain.
- A simple pneumothorax can be diagnosed by X-ray or ultrasound scanning and, although not life-threatening, may be associated with significant underlying lung injury. All traumatic pneumothoraces require close observation. Small ones often absorb spontaneously, but larger ones frequently require chest drainage.
- Open pneumothoraces, or sucking chest wounds, allow bidirectional flow of air through a chest wall defect. The lung on the affected side is exposed to atmospheric pressure with lung collapse and a shift of the mediastinum to the uninvolved side. This must be treated rapidly. In compromised patients, intercostal drains, intubation and positive pressure ventilation are often required. Alternatively, they can be treated by applying an occlusive dressing, taped on three sides to serve as a flap valve, followed by insertion of a chest drain remote from the site of injury. A better dressing is the customised Asherman chest seal, which consists of an adhesive ring, similar to that on a colostomy stoma bag, which projects into a pipe-shaped flap valve, resembling that in a Heimlich valve. Beware of the possibility of a tension pneumothorax developing when one of these is used.

Pulmonary contusion

This is usually caused by blunt trauma, and may occur in association with rib fractures with or without a flail segment. It is common after chest trauma, and is a potentially life-threatening condition. The onset of symptoms may be slow, progressing over 24 hours post-injury. Pulmonary contusion is likely to occur in cases of high-speed accidents, falls from great heights, and injuries by high-velocity bullets.

Symptoms and signs include:

- dyspnoea
- hypoxaemia and cyanosis when severe and not anaemic
- sparse or absent breath sounds
- tachycardia.

Treatment involves supplemental oxygen, careful fluid management and particular attention to pain relief. Endotracheal intubation may be necessary in severe cases.

Traumatic haemothorax

This is more common in penetrating than in non-penetrating injuries to the chest. If the haemorrhage is severe, hypovolaemic shock will occur, and also respiratory distress due to compression of the lung on the involved side.

Optimal therapy consists of the placement of a large chest tube and the concomitant replacement of lost blood. In some instances where the bleeding continues and is significant, open chest surgery is necessary to stop the bleeding (see below).

- A haemothorax of 500–1500 mL in pregnancy that stops bleeding after insertion of an intercostal catheter, can generally be treated by closed drainage alone

Section 42: Major trauma: needle pericardiocentesis

- A haemothorax of greater than 1500–2000 mL in pregnancy with continued bleeding of more than 200–300 mL per hour in pregnancy is an indication for further investigation e.g. thoracotomy.

The injuries listed below are also possible in severe trauma, but carry a high mortality even in well-resourced centres.

1 **Myocardial contusion:** This is associated in blunt chest trauma, with fractures of the sternum or ribs. The diagnosis is supported by abnormalities on ECG and elevation of serial cardiac enzymes (if available). Cardiac contusion can simulate a myocardial infarction. The patient must be closely observed, with cardiac monitoring (if available). This type of injury is more common than realised, and may be a cause of sudden death some time after the accident.

2 **Pericardial tamponade:** Penetrating cardiac injuries are a leading cause of death. It is rare to have pericardial tamponade with blunt trauma. Pericardiocentesis must be undertaken early if this injury is considered likely. Look for pericardial tamponade in patients with:

- shock
- distended neck veins
- no pneumothorax
- muffled heart sounds.

Needle pericardiocentesis

This procedure is used:

- to remove a pericardial effusion that is causing haemodynamic compromise
- to diagnose pericarditis.

In the trauma situation this procedure is performed when cardiac tamponade is suspected. This is usually, but not always, caused by a penetrating injury between the nipple line and the shoulder blades. The clinical findings are shock, muffled heart sounds (although this is a difficult sign to elicit with confidence) and distended neck veins. It is important to differentiate between this and tension pneumothorax, in which the trachea is deviated and air entry reduced on the affected side. Ideally this procedure should be carried out under ECG control, but if that is not available, extra care must be taken.

If available, ultrasound is the easiest/safest way of making a diagnosis of cardiac tamponade.

The following equipment is needed for its treatment:

- ECG monitor
- syringe
- skin prep
- local anaesthetic
- over-needle cannula (16- to 18-gauge)
- sterile drapes.

Technique

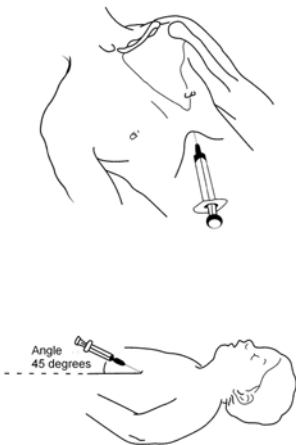

1 Position the patient supine and attach the ECG. Stand on the patient's right with the ECG monitor at the patient's head so that you can see it easily.

2 Clean the skin from nipples to umbilicus and drape with sterile towels to expose the xiphoid region. This must be a sterile procedure. Infiltrate local anaesthetic at the costal margin just below the xiphoid process.

3 Attach the cannula to the syringe. Insert the cannula just below and to the left of the xiphoid process. Angle the needle at 45 degrees to the skin and pointing towards the tip of the left scapula.

4 Advance the needle, holding this position, aspirating all the time and watching the cardiac monitor. As you enter

Figure 42.5 Position for insertion of needle in pericardiocentesis

Section 42: Major trauma: needle pericardiocentesis

The pericardiocentesis needle is inserted as close to the sternum as possible in order to avoid the internal mammary artery. Because of the distended pericardial sac, fluid will flow back into the syringe. If the myocardium is touched, the ECG pattern will change (arrhythmia, ectopics, 'injury' pattern). If you can aspirate large amounts of bright red blood you have entered the ventricle, in which case you should withdraw slightly.

5 If successful, cardiac function should improve immediately. Withdraw the needle, attach a three-way tap, and secure the cannula for further aspirations.

6 This is a temporary procedure, and some patients will require a formal pericardiotomy. Pericardial aspiration may not work well for viscous fluids (e.g. clotted blood) in the pericardial sac.

3 *Thoracic great vessel injuries:* Injury to the pulmonary veins and arteries is often fatal, and is one of the major causes of on-site death.

4 *Rupture of the trachea or major bronchi:* This is a serious injury with an overall estimated mortality of at least 50%. The majority (80%) of the ruptures of bronchi are within 2.5 cm of the carina.

The usual signs of tracheobronchial disruption are:

- haemoptysis
- dyspnoea
- subcutaneous and mediastinal emphysema
- occasionally cyanosis.

5. Trauma to the oesophagus

This is rare in patients with blunt trauma, and more frequent in association with penetrating injury. It is lethal if unrecognised, because of mediastinitis. Patients often complain of sudden sharp pain in the epigastrium and chest, with radiation to the back. Dyspnoea, cyanosis and shock occur, but these may be late features. Urgent IV broad-spectrum antibiotics covering both aerobic and anaerobic organisms, as well as nil-by-mouth nursing, are required.

6. Diaphragmatic injuries

These may occur in association with either blunt or penetrating chest trauma often as part of road traffic accidents. The diagnosis is often missed.

Diaphragmatic injuries should be suspected in a penetrating thoracic wound that is:

- below the fourth intercostal space anteriorly
- below the sixth interspace laterally
- below the eighth interspace posteriorly.

These injuries are more commonly seen on the left side.

7. Thoracic aorta rupture

This occurs in patients who are exposed to severe decelerating forces, such as high-speed car accidents or a fall from a great height. It has a very high mortality due to rapid exsanguination; the total blood volume may be lost in the first minute following injury.

Abdominal trauma

Abdominal injuries are common and, if unrecognised, may prove fatal. Any patient involved in any serious accident should be considered to have an abdominal injury until it has been ruled out.

Unexplained blood loss evident during the primary assessment is frequently due to intra-abdominal haemorrhage.

The abdomen is a classical silent area after trauma. It has to be actively cleared of injury rather than simply noted to be soft and non-tender, especially in the face of altered consciousness.

Cardiovascular decompensation may occur late and precipitously.

The organ most commonly injured in penetrating trauma is the liver, and in blunt trauma the spleen is often torn and ruptured.

Thorough history taking and a careful examination of the abdomen may give clues to the origin of bleeding or perforation.

Section 42: Major trauma: abdominal paracentesis

Gastric distension may cause respiratory embarrassment, and a gastric tube should be placed.

There are two basic categories of abdominal trauma:

- 1 *Penetrating trauma*, where the need for surgical consultation is urgent. For example:
 - gunshot injury
 - stabbing.
- 2 *Non-penetrating trauma*. For example:
 - compression injuries
 - crushing injuries
 - seat-belt injuries
 - acceleration/deceleration injuries.

About 20% of trauma patients with acute haemo-peritoneum have no signs of peritoneal irritation at the first examination, and repeated assessment must be undertaken.

Blunt trauma can be very difficult to evaluate, especially in the unconscious patient. These patients may need abdominal paracentesis, although where ultrasound and/or abdominal CT is available, peritoneal lavage has been superceded. **However, an exploratory laparotomy may be the best definitive procedure if abdominal injury needs to be excluded.**

Remember to check for blood at the external urethral meatus.

Complete physical examination of the abdomen includes rectal examination assessing:

- sphincter tone
- integrity of the rectal wall
- blood in the rectum

Women and girls of childbearing age should be considered pregnant until pregnancy has been excluded. The fetus may be salvageable, and the best treatment of the fetus is resuscitation of the mother. A pregnant mother at term, however, can usually be resuscitated properly only after delivery of the baby. This difficult situation must be assessed at the time (see Section 8).

Abdominal paracentesis

Indications

- To detect intra-abdominal injury after blunt trauma in the haemodynamically stable patient in the absence of CT or ultrasound scanning facilities. Haemodynamic instability after penetrating trauma always requires a laparotomy.
- To identify peritonitis.
- To identify ruptured bowel.

The following equipment is needed:

- local anaesthetic
- sterile drapes
- over-needle catheter, 16- to 20-gauge
- 20-mL syringe
- warmed normal saline and infusion set
- urinary catheter and nasogastric tube
- skin prep (iodine/alcohol).

Procedure

- 1 The procedure must be sterile.
- 2 Decompress the bladder and stomach with a urinary catheter and nasogastric tube.
- 3 Prepare the abdomen (from the costal margin to the pubis). Drape the area with sterile towels, exposing the peri-umbilical region.
- 4 If the patient is conscious, infiltrate local anaesthetic in the midline (a third of the distance between the umbilicus and the pubis). If pelvic trauma is suspected, infiltrate above the umbilicus.

Section 42: Major trauma: abdominal paracentesis

5 Insert the catheter over needle. Remove the needle and aspirate.

6 If more than 10 mL of fresh blood or turbid or bile-stained fluid or faeces or food debris are present in the aspirate, there is a serious problem, indicating the need for a laparotomy.

7 If none of the above abnormalities are seen on aspiration, instil 10 mL/kg of warm sterile normal saline into the abdomen and allow 5 minutes for it to circulate. Then retrieve the fluid.

Interpreting the results of analysis of the retrieved fluid

Abnormal findings include the following:

- red blood cell count (unspun) > 100000/mL: may need laparotomy if unstable
- white blood cell count (unspun) > 500/mL
- bile staining
- faeces
- Gram stain/microscopy positive

If laparotomy is indicated, withdraw the catheter and cover the wound with a sterile dressing. Then transfer the patient to theatre.

In a severely injured patient, a urinary catheter should be inserted.

Management of severe abdominal injury

Abdominal ultrasound (and CT scanning, if available) have become invaluable adjuncts to the secondary assessment, not only for diagnosing intra-abdominal injury, but also for monitoring progress when a defined injury is being managed conservatively.

Bleeding from solid organs may not show up immediately in the resuscitation room, and evidence of hollow-organ rupture may take 24 hours or more to show as free fluid on ultrasound. This commits the trauma team to a high index of suspicion well beyond the classical 'golden hour'.

Patients with refractory shock, penetrating injuries or signs of perforation require laparotomy.

Other injuries may be managed conservatively. After initial fluid transfusion, an experienced surgeon may decide that bleeding from an injured spleen, liver or kidney does not require immediate operative intervention. CT scanning (if available) is an invaluable aid to decision making. **Splenic injury** is relatively common, and can occur after relatively minor trauma, especially if the spleen is enlarged following an inflammatory process or infection, notably malaria. Signs include left upper quadrant pain and tenderness, with referred pain to the shoulder tip. Non-operative management is used frequently in many centres, but long-term problems of splenectomy are insignificant by comparison with the potential consequences of inadequate supervision of conservative management which requires careful monitoring and fluid management with on-site, round-the-clock theatre, anaesthetic and surgical availability: all of which are difficult to provide in a low resource setting.

Increasingly, **liver injuries** are also being managed conservatively. Unlike the relatively straightforward operation of splenectomy, operative liver repair or resection is hazardous, and packing plays a major role in the operative management of uncontrolled hepatic bleeding.

Injuries to the retroperitoneal organs, such as the kidneys or pancreas, may present with vague or atypical signs, again requiring a high index of suspicion. A significant kidney injury does not always cause demonstrable haematuria. Ultrasound studies and dynamic contrast CT scans (if available) may provide valuable information on renal structure and function, but false-negative results commonly occur. Intravenous urography remains useful for demonstrating the details of renal and ureteric injury, especially in centres without a CT scanner.

Pancreatic injury may occur with a normal amylase level, and the amylase level may be raised in the absence of pancreatic damage.

Section 42: Major trauma: log roll

Spinal trauma

Decide whether or not cervical spinal immobilisation is appropriate, especially if it could interfere with airway resuscitation.

Spinal injury should be ruled out in any patient with major trauma capable of damaging the spine. It is often difficult to ascertain whether there has been an injury to the spine or not, particularly in the face of a concomitant head injury.

Distracting pain from a limb injury may lead the patient to ignore and deny neck pain, even when a spinal fracture exists.

Examination of potentially spine-injured patients must be carried out with the patient in the neutral position (i.e. without flexion, extension or rotation), and without any movement of the spine.

The patient should be:

- log-rolled
- properly immobilised (using in-line immobilisation, a stiff neck cervical collar or sandbags)
- transported with the neck in the neutral position.

With vertebral injury (which may overlie spinal cord injury), look for:

- local tenderness
- deformities, as well as (for a posterior spinal cord injury) oedema.

Clinical findings pointing to injury of the cervical spine include:

- difficulties in respiration (diaphragmatic breathing; check for paradoxical breathing)
- flaccidity, with no reflexes (check the rectal sphincter)
- hypotension with bradycardia (without hypovolaemia).

The entire spine should be palpated during a log-roll, when the patient is turned on to their side in a controlled way, keeping the spine in line. The presence of palpable steps, boggy or tenderness should be noted. The limbs should be examined for sensory and motor signs of focal or segmental deficit.

Log roll (*Figure 42.6*)

When examining the back of the patient with major injury, it is important to minimise the risk associated with unrecognised spinal injury. It is essential to examine the back of the patient at the end of the primary assessment (or even during it if there is suspicion of serious injury to the back of the chest or abdomen).

The aim of the log roll is to maintain the orientation of the spine during turning of the patient. It requires ideally 4 people in pregnancy. In addition, one person is required for the examination of injuries.

Figure 42.6 Log rolling

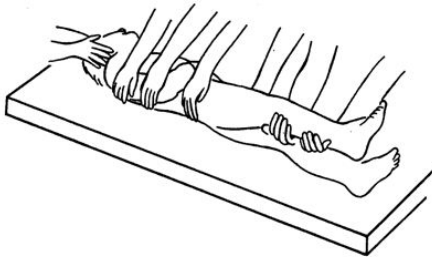

Neurological assessment

Assessment of the level of injury must be undertaken. If the patient is conscious, ask him/her questions relevant to their sensation, and ask them to try to make minor movements, to enable you to assess motor function of the upper and lower extremities.

Key reflex assessment to determine the level of the lesion is summarised below.

Section 42: Major trauma

Motor response

- Diaphragm intact level C3, C4, C5
- Shoulder shrug C4
- Elbow flexion (biceps) C5
- Wrist extension C6
- Elbow extension C7
- Wrist flexion C7
- Abduction of fingers C8
- Active chest expansion T1-T12
- Hip flexion L2
- Knee extension L3-L4
- Ankle dorsiflexion L5-S 1
- Ankle plantar flexion S1-S2

Sensory response

- Anterior thigh L2
- Anterior knee L3
- Anterolateral ankle L4
- Dorsum great and 2nd toe L5
- Lateral side of foot S1
- Posterior calf S2
- Peri-anal and perineal sensation S2-S5

If no sensory or motor function is exhibited, with a complete spinal cord lesion, the chance of recovery is small. A diaphragmatic breathing pattern, bradycardia, hypotension, peripheral vasodilatation suggest a major spinal cord injury.

Throughout the primary and secondary assessments, precautions for spinal protection should ideally be maintained, using a hard collar and side-supports (blocks and straps or sandbags and tape), except for airway procedures and local examination, when manual in-line immobilisation is reinstated.

If the patient is alert, able to communicate clearly and has no distracting pain from another injury, the spine can be cleared clinically without resorting to X-rays. Otherwise, ideally spinal precautions are maintained until radiological clearance is achieved and the patient is re-examined. If possible, three X-rays of the cervical spine should be taken: cross-table lateral view with arm traction to reveal the C7-T1 interface; antero-posterior view and trans-oral odontoid peg view. These must be assessed by an experienced professional (if available), paying particular attention to the soft tissues as well as the bony structures.

If the mechanism of injury warrants it, thoracic and lumbar views are also required.

If the lower cervical spine is not adequately visualised on the lateral view, oblique views are requested. If the X-rays are inadequate or show suspicious areas, CT scanning (if available) is recommended to confirm or exclude a fracture.

Pelvic trauma

Pelvic injury remains a potentially life-threatening injury, especially if associated with a large retroperitoneal haematoma, or if the fracture site communicates with the rectum. External fixation of the pelvis may be valuable in controlling major venous haemorrhage.

It may be difficult to distinguish retroperitoneal haemorrhage from intra-peritoneal haemorrhage, the latter requiring laparotomy.

Tight compressive binding of the pelvis may help bleeding vessels to clot, although this is not practical in the presence of advanced pregnancy.

The purpose of pelvic binding is to reduce the volume of the pelvis thus tamponading any haemorrhage, as well as providing biomechanical stabilisation. This can be achieved by wrapping

Section 42: Major trauma

a folded sheet around the pelvis. The sheet should centre on the greater trochanters and extend to the iliac crests. Taping the thighs or the feet together also helps maintain the anatomical position of the pelvis.

Not all pelvic trauma is serious. Some pubic rami fractures are minor injuries, with little intervention required. Nevertheless, the pelvis is a ring structure that tends to break in two places. On inspecting the pelvic X-ray, careful attention should be paid to the sacroiliac joints and sacral foramina, to seek subtle evidence of a second break in the ring.

Limb trauma

Examination must include:

- skin colour and temperature
- distal pulse assessment
- grazes and bleeding sites
- limb's alignment and deformities
- active and passive movements
- unusual movements and crepitation
- the severity of pain caused by injury.

Management of extremity injuries

Aim to:

- keep blood flowing to peripheral tissues
- prevent infection and skin necrosis
- prevent damage to peripheral nerves.

Special issues relating to limb trauma

Stop active bleeding by applying direct pressure, rather than by using a tourniquet, as the latter can be left on by mistake, and result in ischaemic damage.

Open fractures

Any wound situated in the vicinity of a fracture must be regarded as a communicating one.

Principles of the treatment are to:

- stop external bleeding
- immobilise, and relieve pain.

Early fasciotomy

Compartment syndrome is fairly common, and often underestimated. This condition is caused by an increase in the internal pressure of fascial compartments, which may result from crush injuries, fractures, intramuscular haematomas or amputations. This causes compression of vessels, with resultant hypoperfusion and hypoxia of tissues, including peripheral nerves.

Compartment syndrome is recognised by the following signs in a fractured or otherwise injured limb:

- pain, accentuated by passive stretching of the involved muscles
- decreased sensation
- swelling
- limb pallor
- limb paralysis
- absence of limb pulse.

The final result of this compartment syndrome is ischaemic (or even necrotic) muscles with restricted function.

Fasciotomy involves cutting the fascial bands around the affected muscle to release the pressure within the compartment, allowing the tissues to re-perfuse. The procedure requires a good knowledge of the relevant anatomy, and is usually performed by an orthopaedic surgeon.

Continuing care for patients who have suffered major trauma

Tetanus prophylaxis

This is often forgotten in the management of severe trauma. It is particularly important in pregnancy. In the fully immunised patient, an additional booster will depend on a clinical decision as to the possibility of exposure to contamination, the severity of injury and the timing of the last

Section 42: Major trauma

tetanus immunisation. In an unimmunised or incompletely immunised patient, tetanus immunoglobulin should be given and a full course of or a completing course of tetanus toxoid started (using a different limb to the one receiving the immunoglobulin).

Guidance on tetanus-prone wounds include the following:

- compound fractures
- deep penetrating wounds
- wounds containing foreign bodies (especially wood splinters)
- wounds complicated by pyogenic infections
- wounds with extensive tissue damage (e.g. crush injuries, contusions or burns)
- any wound that is obviously contaminated with soil, dust or manure (especially if topical disinfection is delayed for more than 4 hours).

Section 43: Burns in pregnancy

Summary of management

1. If there are signs of developing or actual airway obstruction, call for an anaesthetist, open the airway and consider early intubation before swelling and total respiratory obstruction occur.
2. Observe closely for shock.
3. Take a very brief history, and consider whether there could be other injuries or medical conditions.
4. Make a rapid assessment of the burn area. Take care with clothing removal.
5. If there are clearly more than 10% burns, establish an IV cannula and give IV analgesia (morphine see Section 5).
6. Commence either Ringer-lactate or Hartmann's solution IV in addition to maintenance fluids the following volumes in mL: burn (%) × weight (kg) × 2 to 4 per day
7. Extra fluid is given over the first 24 hours, backdated to the time of the burn. Half of the fluid should be given (in hourly divided doses) during the first 8 hours, and the second half in the next 16 hours, again in hourly doses. This is **in addition to** maintenance fluids that can be given later and orally if possible. Any fluid boluses given IV to treat shock should be included in the additional fluid for the burn and subtracted from the total calculated as described above.
8. Normal (0.9%) saline can be used if Ringer-lactate or Hartmann's solution are unavailable, but be aware that, especially in larger volumes, hyperchloraemic acidosis may be detrimental.
9. Even if there are less than 10% burns, consider IV opiate analgesia if the patient is clearly distressed by pain.
10. Make an accurate assessment of the area of the burn and draw its position on a chart (see Figure 43.1).
11. Estimate the depth of the burn.
12. Establish, and if necessary update, the anti-tetanus status of the patient.
13. Consider and decide whether an escharotomy is necessary for circumferential burns on a limb or the chest that may cause tissue necrosis from compression by swelling tissues or restriction of ventilation.
14. Dress the burned area.
15. Commence oral fluids if the patient can drink. If not, add the maintenance fluids to those given for the burn as calculated above.
16. Decide whether the patient requires urinary catheterisation (over 30% burns, or burns with complications).

Capillary permeability is increased for up to 48 hours, and is maximal at 8 hours. With large burns there is increased blood viscosity, haemoglobinuria may occur, and there is a loss of protein, which needs to be corrected by adequate nutrition.

Special issues regarding burns in pregnancy. Any burn affecting more than 20% total body surface area (TBSA) is a serious risk to the mother and fetus. In a mother with a burn > 70–80% of the TBSA mortality is 50–90%. If the burn affects < 30% TBSA the prognosis is good for both

Section 43: Burns

fetus and mother and depends on the management of complications such as hypoxaemia, hypotension and sepsis.

Primary assessment and resuscitation

Airway and Breathing

- If either of these is compromised, call for an anaesthetist and open the airway. Early endotracheal intubation may be required.
- If flame inhalation has occurred, the airway tends to close very rapidly, making intubation very difficult. Apart from the history, the signs to observe are altered voice or presence of stridor, singeing of the nasal hairs, and deposition of soot in the throat or nose.
- Remove any constricting clothing and place the patient in dry and clean sheets or towels.
- Give additional inspired oxygen if SaO_2 is $< 94\%$ or the patient is cyanosed.
- If breathing is inadequate, use a bag-valve-mask and consider intubation if the airway is compromised or may imminently become so.
- Chemical damage may occur from highly irritant gases, which can lead to progressive respiratory failure.
- Many plastics and modern materials give off cyanide, which may be absorbed into the blood stream.
- Carbon monoxide is the most common poison produced in fires.

Circulation

- Fluid is lost through the capillaries following a burn. Shock takes time to develop. In minor burns this is a local phenomenon, but in severe burns all of the vascular bed becomes leaky. Assess the total body surface area (TBSA) affected (see below).
- A patient with a burn of less than 10% of the total body surface area can normally cope by having their oral intake increased. However, this is not an absolute figure, and in particular if the patient is vomiting, IV fluid may be necessary for a smaller burn. Similarly, if safe IV fluid is not available, a burn of up to 25% may have to be managed with increased oral fluids alone. When oral fluids are being used, either in combination with IV therapy or alone, only small regular doses of fluid should be given by mouth.
- For burns that are 5% or larger, oral fluids should be an electrolyte solution (ORS).
- Fluid loss is greatest in the first 12 hours, causing disturbances in fluid and electrolyte composition.
- For burns of 10% or more, secure IV access and replace fluids with warmed Ringer-lactate or Hartmann's each containing 5 or 10% glucose (see below for calculating TBSA and the Appendix for how to make up solutions containing glucose).

Management of the circulation in pregnancy

A pregnant woman requires 2 to 4 mL per kg per 1% of body surface area burnt to be given over the first 24 hours in addition to baseline maintenance fluids. Half of this volume is given in the first 8 hours, half in the next 16 hours. The quantity of fluid given in the first 8 hours must include any fluids given as a resuscitation bolus for shock.

- Monitor urinary output (should be > 30 mL per hour).
- Assess the need to deliver the fetus. Fetal survival is poor in burns affecting $> 50\%$ TBSA. In view of the high mortality in mothers with such extensive burns, those in the second or third trimester should be delivered as soon as possible after admission as fetal survival is not improved by waiting and the presence of the fetus increases the risk to the mother. Abortion is common in patients with burns $> 33\%$ TBSA, especially during the second trimester. Fetal loss during the third trimester can be expected with extensive burns unless delivery occurs. Dexamethasone to reduce respiratory distress syndrome in a preterm infant (see Section 25) is not contraindicated in the presence of extensive burns.
- IV Ringer-lactate or Hartmann's solution or 0.9% saline (if the former two are not available) is necessary in large burns because of the loss of the intravascular component of extracellular fluid. Glucose 5% alone and glucose in 0.18% saline are dangerous and can lead to hyponatraemia and water overload and must not be given. However, watch for hypoglycaemia,

Section 43: Burns

which can be prevented by adding glucose to any crystalloid solution (e.g. 50 mL of 50% glucose in a 500-mL bag of crystalloid will give a 5% solution).

- Ideally, give IV fluids by peripheral or external jugular vein; in an emergency, in shock or where rapid sequence induction for intubation is needed, intra-osseous or central venous lines may be needed, but the latter can increase the risk of infection.
- If the patient is in shock, give a 500 mL IV bolus and then reassess and repeat if they are still shocked, up to a maximum of three boluses.
- Wherever possible, long IV lines should not be used, as this seriously increases the risk of septicaemia.
- Both natural colloids (i.e. albumin solution and plasma) and artificial colloids (e.g. Haemacel, and various starch derivatives) can be used in shock.
- It is essential that not too much IV fluid is given, as it may lead to pulmonary and/or cerebral oedema, together with an excessive extravascular deposition of fluid. Crystalloid resuscitation can also lead to 'compartment syndrome' because of the increasing pressure within the muscular compartments and it is important to observe for pain, particularly in the lower legs.
- The amount of fluid loss from burns decreases over the first 48–72 hours after the injury. The amount of fluid to be given initially therefore depends on how long before admission the burn occurred. Following this, the assessment of the resuscitation can be made by a combination of the clinical picture, i.e. degree of dehydration, the blood haematocrit and the urine output aim for 30 mL/hour in pregnancy.
- It is essential that accurate and updated fluid input and output charts are kept throughout. For major burns (over 30%), hourly haematocrit (or haemoglobin) and urine outputs are helpful in the first 24 hours, decreasing in frequency thereafter. For burns between 10% and 30%, 4-hourly tests are normally sufficient.
- In larger burns (greater than 30%) and burns involving the genitals a urinary catheter is essential if fluid resuscitation is not proceeding well to give an accurate picture of the urine volume produced hourly. Catheters can lead to infection and should be removed as soon as possible.

Enteral fluid management

- Start oral or nasogastric feeding as soon as possible after admission.
- Although thirst is common, giving too much free fluid orally may induce vomiting.
- For burns between 5% and 10% the daily requirement of the patient's oral intake should be increased by 50% to allow for the burn (given on an hourly basis).
- The normal daily fluid requirement in pregnancy is 1500–2500 mL.
- This may need to be increased by 10% or 20% in hot climates.
- The oral fluid given should ideally be ORS. If this is not available, diluted milk is acceptable.
- If all is well after 24 hours, free fluids can be given, but careful input and output charting will continue to be required.

Feeding

- Early feeding reduces the risk of gastric stress ulcer formation and of stasis. It is recommended therefore that small quantities of food are given either orally or with a thin-bore nasogastric tube. The latter can be used to give milk or other similar high-protein foodstuffs.
- **Parenteral IV nutrition is dangerous, as this leads to a high risk of septicaemia in burns patients.**

Area of burn

In pregnancy the abdomen represents a larger proportion of the TBSA.

The area of the patient's hand can be used for estimating the size of small burns, but can also be used to estimate the areas that are unburned in extensive burns, and this can then be extracted from the rule of nines figures (e.g. if 2% of an arm is unburned, the area of burn on that arm will be 7%).

- It is common for inexperienced people to overestimate the size of a burn.
- Erythema must not be included, as fluid is not lost.
- The decision as to whether or not to start IV fluids is dependent on this initial assessment, and on whether there are other injuries or medical conditions.
- An overestimate may mean that far too much fluid is given.

Figure 43.1 Wallace's 'rule of nines' for burns assessment in pregnancy

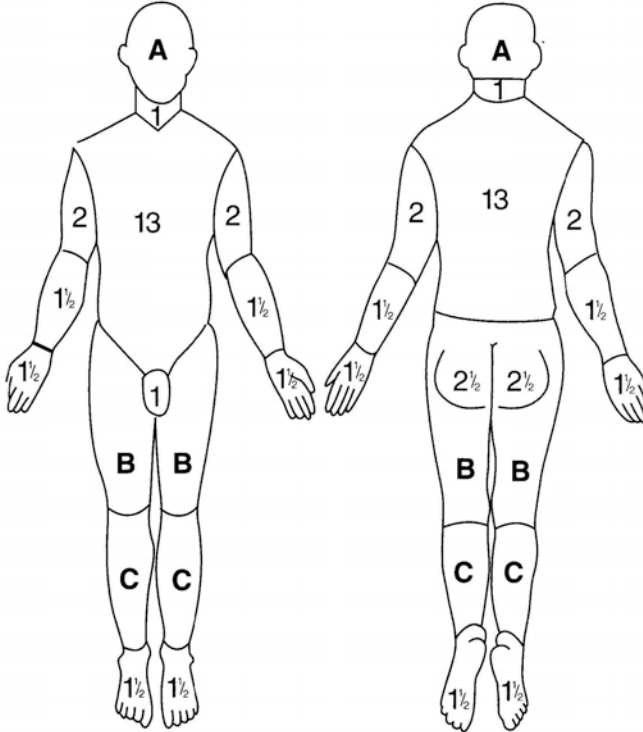

Depth of the burn

The depth of the burn is based on history, appearance and examination.

- Flame or hot fat burns are almost always deep.
- Hot water burns (scalds) may be superficial or deep dermal.
- The appearance can be altered if more than a few hours old, or by the application of various first-aid treatments.
- First assess capillary return. Prompt capillary return means a superficial burn.
- Then test sensation. Is it increased (in a superficial partial thickness burn), reduced (in a deep dermal burn) or absent (in a full-thickness burn)?
- The test is done by using a sterile hypodermic needle; ask whether they can tell the difference between the sharp and the blunt ends when these are lightly applied to the burn.
- In full thickness burns the area is insensitive to pain and may appear dirty or white (the eschar).
- A simple test to distinguish between partial and full thickness burns is to pull a hair out: if it comes out easily the burn is full thickness.

Many superficial burns become deeper during the first 48 hours after their occurrence, and need to be reassessed at 48 hours.

Treatment of skin surface burns

Analgesia

In all cases of shock, or potential shock, IV morphine analgesia should be given (see Section 5). Oral analgesia is ineffective, and IM analgesia can be dangerous because when the circulatory

Section 43: Burns

volume is re-established and muscle blood flow recommences, the patient can become overdosed. Opiate overdose can be reversed with naloxone given intravenously (see Section 5).

Treatment of the burn itself

If possible, isolate the patient in a warm clean room. The following patients require admission:

- all airway burns or patients with a history of smoke inhalation
- burns of more than 5% TBSA
- deep burns more than 5 cm in diameter
- moderate burns of the face, hands or perineum
- circumferential burns of the thorax or extremities*
- electrical burns
- where there is inadequate social support in the home

*If circumferential full-thickness burns involving the extremities or the chest are present, escharotomy may be necessary.

Dressings

Because a burn is normally caused by hot fluids or flame, the burn wound is initially sterile.

Hands should be washed and sterile gloves should be worn by all members of the team whenever the patient is being touched. Ideally plastic aprons should also be used to prevent cross-infection during dressings, etc.

The purposes of a dressing are:

- to maintain sterility
- to relieve pain
- to absorb fluid produced by the burn wound
- to aid healing.

Placement of the dressing

The layer of the dressing closest to the wound should be non-adherent (e.g. paraffin gauze) and may contain an antiseptic, such as silver sulphadiazine, although the evidence that antiseptics are useful to prevent infection and promote healing is uncertain.

- On top of this dressing should be placed a layer of gauze and then sterile cotton wool to absorb fluid.
- The whole dressing should be held in place by a bandage.

Dressing changes

Every time a dressing is changed, there will be pain, and the delicate reforming epithelium will be injured.

Therefore dressings should not be changed on a daily basis, particularly in a superficial partial-thickness wound. The initial change should be at approximately 48 hours after the burn, when dressings come off easily, the maximum amount of fluid has been discharged from the wound, and it is possible to reassess the wound for area and depth.

Effective pain relief is vital at dressing changes or the patient will come to dread the procedure. Providing an anaesthetist is present, Ketamine provides excellent brief high quality analgesia of up to 15 minutes with an IV injection (over 1 minute) of 250 microgram/kg ketamine. For longer analgesia, an infusion will be needed. A safer alternative, especially in pregnancy, is oral morphine (see Section 5 for doses) given about 30 minutes before the anticipated dressing change.

- If at the first dressing change, the wound is still a superficial partial-thickness burn, the second dressing is left for a further 8 days, by which stage healing should have occurred.
- If the wound is deeper, a decision as to whether to operate must be made (see below), but the second dressing can still be left for at least a week.
- If surgery is not possible or appropriate, dressings can be done initially on a weekly basis but increased to two or three times a week as greater infection and discharge develops.
- Take a sample for microbiology (if available).

Tetanus

Anti-tetanus prophylaxis should be given at the earliest possible time.

Antibiotics

- Haemolytic *Streptococcus pyogenes* and *Pseudomonas aeruginosa* are the most common serious infections.

Section 43: Burns

- In most burns, *Staphylococcus aureus* is also present, but does not need treatment unless it is invasive. If it is, flucloxacillin or cloxacillin is more appropriate than penicillin.
- Antibiotics should only be given when there are signs of infection.
- *Streptococcus pyogenes* should be treated with benzyl penicillin and flucloxacillin if found on a swab or suspected clinically (e.g. lymphangitis).
- *Pseudomonas aeruginosa* can be treated with ceftazidime, piperacillin, aztreonam, gentamicin or tobramycin.

Surgery

Immediate surgery

There are two operations which may need to be done within hours of the burn:

1. Tracheostomy

- Whenever possible this operation should be avoided, as an endotracheal tube usually gives better results and less mortality (depending on available intensive care).
- An emergency tracheostomy for a severely swollen oral, pharyngeal or laryngeal airway is a very high-risk operation if the airway has not already been secured. It is better to use a mini-tracheostomy through the cricothyroid membrane.
- Tracheostomy has a high mortality because of infection, displacement, lung-volume loss and tube blockage.

2. Escharotomy

- A deep circumferential full-thickness burn of the limb, or even occasionally the trunk, can act as a tourniquet to that area.
- Very early release (i.e. within 2 hours) is necessary to prevent severe and irrecoverable muscle and nerve damage. This can be done without any anaesthetic because the deep burn has no sensation.
- The incisions should not overlie superficial bone or tendons, but need to go down to the fascia.
- For more severe burns, and in particular high-voltage electrical burns, appropriate incisions are needed to decompress the deep compartments as well.
- Urgent decompression of deep compartments may be required in severe high-voltage electrical burns, which can damage the underlying muscle with no skin damage visible except at the entry and exit points.

See Textbook for more on surgical management of burns.

One of the most serious problems is **cross-infection** between patients, and adequate plastic aprons, gloves and hand-washing facilities must be available for all staff and relatives.

- In the early stages of burn resuscitation, and after surgery, nursing should be on a one-to-one basis (if available).

Inhalational burn injury

This includes:

- thermal damage
- asphyxiation
- pulmonary irritation.

Thermal damage

- is usually limited to the oropharyngeal area.
- exceptions are injuries caused by steam, volatile gases, explosive gases or aspiration of hot liquids.

Asphyxiation

Combustion utilises oxygen in the burning environment, leading to hypoxia. The production of carbon monoxide within the burning environment causes further tissue hypoxia by:

- decreasing the oxygen-carrying capacity of the blood
- shifting the oxyhaemoglobin saturation curve towards the left
- decreasing myocardial contractility.

The highest possible concentration of oxygen should be given in carbon monoxide poisoning.

Section 43: Burns

Cyanide gas can be released during the combustion of plastics, polyurethane, wool, silk, nylon, nitrites, rubber and paper products. It is 20 times more toxic than carbon monoxide, and can cause immediate respiratory arrest.

Methaemoglobinaemia occurs due to heat denaturation of haemoglobin, oxides produced in fire, and methaemoglobin-forming materials such as nitrites. Rarer than cyanide and carbon monoxide toxicity, this decreases the oxygen-carrying capacity of the blood and causes a shift of the oxyhaemoglobin dissociation curve to the left, similarly to carboxyhaemoglobin (HbCO). **Again treat with high concentrations of oxygen.**

Inhalation of hot gas normally does not injure distal airways, as the heat-exchange capacity of the upper airway is excellent. Distal airway injury is more likely to be due to the direct effects of the products of combustion on the mucosa and alveoli.

Pulmonary irritation

- Direct tissue injury.
- Acute bronchospasm.
- Activation of the body's inflammatory response system.

Evidence of inhalational injury

- Burns around the mouth.
- Soot in the mouth or nostrils.
- Carbonaceous sputum.
- Singed facial or nasal hairs.
- Facial burns.
- Oropharyngeal oedema.
- Changes in the voice (hoarseness), and stridor.
- Altered mental status.
- History suggesting confinement in a smoke-filled environment.

Treatment of inhalation burns

1. Symptoms may be delayed until 24–36 hours after injury. Ensure by very close observation that if the airway is deteriorating endotracheal intubation is undertaken **before** dangerous obstruction develops.
2. Deliver high-flow supplemental oxygen.

Ingestion burns

Hot fluids

- Normally only the mouth is burned.
- Swelling and blistering can be rapid, and require an oral or nasal (preferred) airway.
- Swelling usually goes down within 48 hours, and further treatment is unusual.

Caustic fluids

- Burns from drinking caustic fluids are much more severe.
- Caustic alkali solutions are more damaging than acids. Do not make the patient vomit, as burning fluid causes further damage when passing up the oesophagus.
- **Do not pass a tube into the stomach**, as this may perforate the oesophagus. A gastrostomy will usually be needed
- **Do not attempt to neutralise the chemical** (e.g. by giving acid for alkali ingestion, or alkali for acid ingestion), as this will cause a high-temperature reaction that will further damage the tissues.
- **Do not give more milk or give water**: it is too late and may precipitate vomiting and more damage to the oesophagus.

Definitive treatment

The only way to assess the oesophageal damage is by flexible oesophagoscopy. If there are significant signs of inflammation, steroids can reduce the severity of any developing stricture

Section 43: Burns

(hydrocortisone 100 mg IV 6 hourly). The length of treatment should be short (3–4 days) in view of the effect of steroids on healing and immunity.

Significant stricture formation will need reconstructive surgery or a gastrostomy (see below).

Complications

- Serious burning, particularly of the oesophagus, can lead to perforation, and in the later stages to strictures.
- Acute perforation of the oesophagus is frequently fatal; treat by IV fluids, IV antibiotics and suction and then thoracotomy if severe.
- Late stricture during and after the healing phase is a common problem.
- If the stricture reduces the ability of the patient to eat, a feeding gastrostomy tube may be needed to provide nutrition.

Section 44: Poisoning in pregnancy

Symptoms and signs of poisoning include:

- respiratory distress
- acidotic breathing
- tachycardia or flushing
- cardiac arrhythmias
- hypotension
- diarrhoea
- vomiting
- drowsiness or coma
- convulsions
- ataxia
- pupillary abnormalities
- hypoglycaemia
- acidosis.

Management of poisoning in pregnancy

Primary assessment and resuscitation

The whole assessment should take less than a minute. Treat any problems with the ABC approach as they are found.

Once Airway, Breathing and Circulation are recognised as being stable, or have been stabilised, definitive management of specific conditions can proceed. During definitive management, re-assessment of ABC at frequent intervals will be necessary to assess progress and detect deterioration.

Secondary assessment and emergency treatment

Identify the substance ingested or inhaled, if at all possible.

Common symptoms/signs after ingestion of poisons

Reduced conscious level or seizures due to hypoglycaemia: test blood glucose levels for all patients, and if hypoglycaemia is present, treat with a sugar drink orally if the patient is conscious. If they are unconscious give glucose by IV or intraosseous routes.

In pregnancy dilute 50 mL of 50% glucose with 50 mL of Ringer-lactate, Hartmann's or 0.9% saline and give IV over 5 minutes followed by an IV infusion of Ringer-Lactate or Hartmann's containing 5% glucose (see Appendix). If blood glucose testing is not available, then treat for hypoglycaemia if this diagnosis is possible

Convulsions:

Providing these are not due to hypoglycaemia consider a loading dose of diazepam in 2 mg increments IV every 2 minutes up to 10 mg. The maintenance dose is diazepam 40 mg in 500 mL of Ringer-lactate or Hartmann's solution, titrated to keep the mother sedated but able to be woken and without hypoventilation. Maternal respiratory depression may occur when the dose exceeds 30 mg in 1 hour.

Alternatively, in pregnancy the loading dose of diazepam rectally is 20 mg in a 10-mL syringe. Remove the needle, lubricate the barrel and insert the syringe into the rectum to half its length. Discharge the contents and leave the syringe in place, holding the buttocks together for 10 minutes to prevent expulsion of the drug. Alternatively, the drug may be instilled in the rectum through a catheter.

Ensure close observation after treatment with diazepam and make sure that a bag-valve-mask of suitable size is available and the health worker giving the diazepam knows how to use it.

Minimising the effects of the ingested substance as quickly as possible

1. If the substance is non-toxic give oral fluids liberally.

Section 44: Poisoning

2. If the substance is corrosive, there may be serious injury to the mouth, throat, airway, oesophagus or stomach. The most dangerous substances are sodium or potassium hydroxide cleaning fluids (e.g. toilet cleaners). Others include bleach and other disinfectants. Serious oesophageal injury can result in perforations and mediastinitis, later leading to oesophageal strictures. The presence of burns within the mouth is of concern, and suggests that oesophageal injury is possible. Stridor suggests laryngeal damage.

3. For all poisons/drugs except heavy metals, iron, alcohol and corrosive substances (as above) give activated charcoal 50 grams suspended in water. The sooner it is given the better (preferably within 1 hour of ingestion). Repeat after 4 hours if a sustained-release drug has been taken.

4. Admit all patients with symptoms or signs attributable to poisons, all patients who have ingested iron, pesticides, corrosives, paracetamol, salicylates, narcotic or tricyclic antidepressant drugs and any patient who admits deliberate ingestion.

Commonly ingested poisons

Local medicines

These are often prescribed for diarrhoea and vomiting. They may cause profound acidosis and respiratory distress. They can also cause paralytic ileus.

- Treat the metabolic disturbance.
- Pass a nasogastric tube if ileus is present.

Iron

Iron poisoning causes severe gastrointestinal effects, with vomiting, diarrhoea, gastrointestinal bleeding and metabolic acidosis. Subsequently after 12–24 hours there is encephalopathy, liver damage and circulatory collapse. Late effects include scarring of the stomach, which may produce pyloric stenosis.

- If available, a serum iron level at 4 hours of more than 300 micrograms/dL indicates significant poisoning.
- X-ray may show the number of tablets.
- Do not use gastric lavage in pregnancy.
- Desferrioxamine 2 grams should be given by deep IM injection. IM doses of desferrioxamine of 2 g should be repeated every 12 hours until serum iron is normal (serum iron less than the iron binding capacity). If the patient is very ill, give an IV infusion of desferrioxamine 15 mg/kg/hour up to a maximum dose of 80 mg/kg in 24 hours. Usually reduce the rate after 6 hours.

Opiate or methadone overdose

Give naloxone even if poisoning is only suspected (because of the presence of such drugs in the home) or because breathing is shallow or the patient has stopped breathing.

If the patient is hypoventilating or has stopped breathing, ventilate with bag-valve-mask before giving the naloxone as the combination of hypercapnia with naloxone can cause arrhythmias, acute pulmonary oedema or seizures.

If suspected, give naloxone 400 microgram to 2.0 mg IV; if there is no response, repeat every 2–3 minutes up to a maximum of 10 mg (then review the diagnosis).

Naloxone has a short half-life and further boluses or an infusion of 10–20 micrograms/kg/hour or more may be required.

Paracetamol

Paracetamol poisoning can lead to liver and renal failure and if possible, measure the paracetamol level (see Figure 44.1).

Section 44: Poisoning

- Give N-acetylcysteine or methionine as soon as possible, ideally within 8 hours of ingestion. If the patient is conscious and tolerating oral fluids, and within 8 hours of ingestion, give methionine orally in pregnancy 2.5 g every 4 hours for four doses.
- If the patient presents more than 8 hours after ingestion or cannot be given an oral preparation, give IV N-acetylcysteine (initially as a loading dose of 150 mg/kg over 15 minutes, then as an IV infusion of 50 mg/kg over 4 hours, and finally as 100 mg/kg IV over 16 hours). An oral form of N-acetylcysteine is available (give a loading dose of 140 mg/kg, and then 70 mg/kg every 4 hours for 16 doses).

A plasma level that falls above the treatment line at different times indicated in the graph of paracetamol level against time after ingestion indicates moderate to severe poisoning. Treat with N-acetylcysteine.

*Figure 44.1
Treatment levels
In Paracetamol
poisoning*

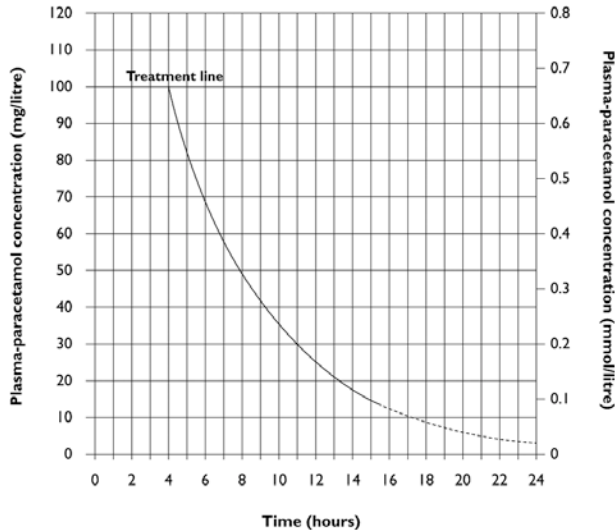

Salicylates

Salicylate poisoning produces acidotic breathing, vomiting and tinnitus. Hyperventilation is due to direct stimulation of the respiratory centre and produces respiratory alkalosis, but also there is a metabolic acidosis from ketosis. Consequently, the hyperventilation is extreme. A fever may occur. There is peripheral vasodilatation. Moderate hyperglycaemia develops.

Treatment

1. There is delayed gastric emptying, so give activated charcoal if available (50 gram in pregnancy and repeat after 4 hours) even if more than 4 hours after ingestion.
2. Give sodium bicarbonate 1 mmol/kg IV as 4.2% over 4 hours to correct acidosis and aid excretion of salicylate.
3. Give sufficient IV fluids to compensate for hyperventilation, and give sufficient glucose to minimise ketosis, but regularly monitor blood glucose levels.
4. Monitor electrolytes carefully and avoid hypokalaemia and hypernatraemia.
5. In very severe cases, peritoneal haemodialysis (if available) is ideal. In its absence, exchange transfusion may help.

Benzodiazepines

Flumazenil is a specific antagonist. In pregnancy give 200 micrograms IV then 100 micrograms per minute IV up to a maximum total of 1 mg until reversal has occurred.

Tricyclic antidepressants

In overdose these cause drowsiness, ataxia, dilated pupils and tachycardia. Severe poisoning results in cardiac arrhythmias (particularly ventricular tachycardia) and severe hypotension and convulsions.

Treatment

1. Administer charcoal.
2. Treat convulsions as for any status epilepticus.
3. Monitor the ECG (if available) continuously.
4. Arrhythmias can be reduced by using IV phenytoin which must be diluted only in 0.9% saline. Phenytoin is given as a loading dose of 15–20 mg/kg over 30–45 minutes (maximum dose 2 grams) and then 2.5–7.5 mg/kg 12 hourly. The maximum infusion rate is 1 mg/kg/minute (maximum 50 mg/minute). A lidocaine infusion (10–50 micrograms/kg/ minute) is an alternative to phenytoin.
5. Alkalinisation of the intravascular compartment has been shown to reduce the toxic effects on the heart. Give sodium bicarbonate 1–2 mmol/kg slowly over 15 minutes. This can be repeated if necessary. The aim is to increase the arterial pH to 7.45–7.5.
6. Prolonged and effective cardiac massage with ventricular tachycardia can give time for the drug to be excreted.

Poisonous household and natural products

Petroleum compounds such as kerosene, turpentine and petrol

If inhaled these may cause hydrocarbon (lipoid) pneumonia, leading to a cough, and respiratory distress with hypoxaemia due to pulmonary oedema and lipid pneumonia.

If large amounts are ingested they may cause encephalopathy.

Treatment

1. Do not induce vomiting.
2. Additional inspired oxygen may be required.
3. An antibiotic may be needed, but only for secondary chest infections.
4. Dexamethasone may help in lipid pneumonia.

Organophosphorus compounds and carbamates

Insecticides such as malathion, chlorthion, parathion, TEPP and phosdrin can be absorbed through the skin, lungs or gastrointestinal tract. Symptoms are due to excessive parasymphathetic effects caused by inhibition of cholinesterase, and include excessive secretions of mucus in the lungs (bronchorrhoea) with ensuing respiratory distress and sometimes wheezing, salivation, lacrimation, bradycardia, sweating, gastrointestinal cramps, vomiting, diarrhoea, convulsions, blurred vision and small pupils, muscle weakness and twitching, progressing to paralysis, and loss of reflexes and sphincter control.

Treatment

1. Remove poison from:
 - the eyes: use copious irrigation
 - the skin: remove contaminated clothing and wash the skin
 - the gastrointestinal tract: give activated charcoal 1 gram/ kg and repeat after 4 hours.
2. Admit all cases, as some effects do not appear until a late stage.
3. In severe cases, particularly where there is bronchorrhoea, give atropine (in pregnancy give 600 micrograms and repeat in doses of 300 micrograms as needed).
4. A specific cholinesterase reactivator can also be given as follows, and ideally within 12 hours of ingestion (it is ineffective after 24 hours).

Pralidoxime 30 mg/kg diluted with 10–15 mL of water by IV infusion at a rate not exceeding 5 mg/minute. It should produce an improved muscle power in 30 minutes. It can be repeated once or twice as required and as is shown to be effective, or an infusion of 8 mg/kg/hour can be used. Maximum dose is 12 gram in 24 hours.

5. Assisted ventilation may be required (if available).

Section 44: Poisoning

Bleach (3–6% sodium hypochlorite)

Do not induce vomiting.

- Symptoms: burning sensation, vomiting and abdominal discomfort.
- Treatment: liberal fluids and milk.

Other corrosive agents

Do not induce vomiting.

- Oven cleaners (30% caustic soda).
- Kettle descalers (concentrated formic acid).
- Dishwashing powders (silicates and metasilicates).
- Drain cleaners (sodium hydroxide).
- Car battery acid (concentrated sulphuric acid).

Symptoms: considerable tissue damage to the skin, mouth, oesophagus or stomach; late strictures may occur.

Treatment consists of washing the skin and mouth to dilute the corrosive fluid. No emetic should be given. Milk or water given as soon as possible may be of benefit, especially with solid caustics such as sodium hydroxide crystals. Never give salt to induce vomiting.

If there is a severe stricture it may be necessary to bypass the oesophagus with a gastrostomy tube. Ideally, flexible endoscopy should be performed to identify injury, but this may not be available. A perforated oesophagus will lead to mediastinitis and should be treated with gastrostomy and prophylactic antibiotics (cefuroxime and metronidazole).

Lead poisoning

This is usually a chronic form. The lead can come from paint, lead piping or car batteries. In some cultures, lead-containing substances may be applied to the skin for cosmetic purposes.

Early signs are non-specific (e.g. vomiting, abdominal pain, anorexia).

Anaemia is usually present. There is a microcytic hypochromic anaemia with punctate basophilia.

Prior to encephalopathy with raised intracranial pressure, there may be headaches and insomnia. Peripheral neuropathy may be present.

X-rays may show bands of increased density at the metaphyses.

Harmful effects on the kidneys result in hypertension, aminoaciduria and glycosuria.

The diagnosis is made by showing a marked increase in urinary lead levels after d-penicillamine, and elevated blood lead levels.

Treatment

Treat by first removing the source of ingested lead.

A diet rich in calcium, phosphate and vitamin D (plenty of milk) should be given if possible.

In cases of lead encephalopathy, give an IV infusion of edetate calcium (EDTA) in 5% glucose or normal saline, 20 mg/kg every 6 hours for 5–7 days at a concentration of no more than 30 mg/mL. Give over an hour.

Boluses of mannitol (in pregnancy give 20 grams of 20% mannitol over 15 minutes as soon as cerebral oedema is suspected. Repeat every 4–6 hours) may also be required for raised intracranial pressure while the above is given.

Carbon monoxide poisoning

Toxic effects are due to hypoxaemia. Cerebral oedema may develop.

Treatment: Move the patient from the source and give them 100% oxygen as soon as possible (the half-life of carbon monoxide is 5 hours in room air, but only 1.5 hours in 100% oxygen). The patient may look pink but is hypoxaemic, so base the duration of oxygen treatment on other clinical signs of hypoxia rather than on cyanosis, which will be masked. For similar reasons, pulse oximeters will give falsely high readings. ABCD management according to APLS may be required

Section 45: Care of the newborn infant

The baby at risk of developing problems at birth

Preterm birth: Preventative strategies

Minimising the risk of surfactant deficiency: this can be halved if the mother is given a short course of high-dose steroid treatment before delivery:

- dexamethasone, 12 mg IM, two doses 12 hours apart
- or dexamethasone, 6 mg IM, four doses 12 hours apart.

Stopping premature uterine contractions:

- Give 20 mg nifedipine orally. Up to three further doses can be given at 30-minute intervals if uterine contractions persist.
- If this stops labour, give 20 mg nifedipine orally three times a day for the next 3 days.

Other problems associated with preterm birth include:

- Increased risk of hypothermia
- Nutritional difficulty. Breast milk is ideal, and everything possible should be done to help the mother sustain her lactation until the baby is ready to feed reliably from the breast. A limited ability to suck and swallow usually appears from 32 weeks' gestation, but it remains unpredictable, unreliable and uncoordinated until 36 weeks' gestation. In the event that breastfeeding cannot be initiated immediately after birth, mothers should be encouraged to start expressing breast milk, to be given by nasogastric tube or cup and spoon.
- Partial breastfeeding can also help the mother to sustain her lactation, but in any event the mother should regularly express milk. Some mothers might find expressing breast milk difficult and may require help with this.
- Infection
- It is important to identify babies at risk of infection prior to delivery. If identified, the mother should be given antibiotics. Many of the babies who become infected during delivery develop respiratory signs very soon after birth, but in a few, the features are those of neonatal sepsis. In addition, there are a proportion of babies who are initially asymptomatic, and therefore prophylactic antibiotics should be commenced in the infant if there are risk factors for infection.

When to consider antibiotics for the mother and newborn infant

- Symptomatic ascending infection in utero needs urgent treatment. If this is overlooked, both the mother's and the baby's life will be in danger.
- Asymptomatic infection is, however, a much commoner problem. This occasionally progresses so rapidly once labour starts that, unless treatment is started at once, the baby will die even if the most appropriate antibiotic is given immediately after birth. Because such infection by definition is silent, it is important that treatment be considered in any mother going into active spontaneous labour before 35 weeks' gestation.
- Membrane rupture can be both a sign of, and a risk factor for, ascending bacterial infection. What most people mean by premature rupture of membranes (PROM) is really preterm pre-labour rupture of membranes (PPROM), where the membranes rupture before there is any overt sign of uterine activity or any detectable uterine contractions. When this happens in the preterm baby, it is often a sign of the start of some sort of ascending infectious process. This

Section 45: Care of the newborn and neonatal resuscitation

process has already weakened the amniotic membranes and may stimulate the onset of preterm labour. Antibiotics must be given to the mother.

- Treatment with antibiotics should also be considered **at any gestation** if the mother's membranes rupture more than 18 hours before delivery. If premature rupture of membranes occurs before the onset of premature labour contractions then infection is more likely.
- Maternal fever ($> 38^{\circ}\text{C}$) in labour is a strong indication for initiating antibiotics for the mother. Similarly, foul-smelling or purulent liquor requires IV antibiotic treatment of the newborn from birth without waiting for any signs of infection.
 - In mothers with PPROM who show signs of being clinically infected give IV antibiotics.
 - In PPROM where there is no evidence of infection and no evidence of labour you can delay delivery by 1 week or more (on average) by giving the mother amoxicillin or, better still, erythromycin.
 - In mothers who are in active labour 5 or more weeks before term and who give a clear history that the membranes had ruptured before they were able to detect any uterine contractions, the risk of the baby becoming infected during delivery can be reduced substantially by giving antibiotics IV (ideally probably both penicillin and gentamicin) during labour.

Antibiotic management of perinatal infection

Where facilities allow, a blood count, C-reactive proteins and blood cultures should be taken before starting antibiotics. Because a range of bacteria can be involved, treatment of the baby needs to protect against group B streptococcal, coliform and Listeria infection, making a combination of ampicillin and gentamicin the best strategy:

Give ampicillin 50–100 mg/kg IV 12-hourly **plus** gentamicin 5 mg/kg every 24 hours IV if more than 32 weeks' gestation, and 3 mg/kg if less than 32 weeks.

The WHO recommends that a neonate with risk factors for infection (i.e. membranes ruptured > 18 hours before delivery, maternal fever $> 38^{\circ}\text{C}$ before delivery or during labour, or foul-smelling or purulent amniotic discharge) should be treated with prophylactic antibiotics (IM or IV ampicillin and gentamicin) for at least 2 days. After this the neonate should be reassessed and treatment continued only if there are signs of sepsis (or a positive blood culture).

Hypothermia (see Textbook)

Hypothermia seriously increases the risk of surfactant deficiency and hypoglycaemia, and must be avoided.

Management at delivery of a baby not needing resuscitation

- Deliver the baby on to the mother's abdomen or a warm surface, dry and cover.
- Clamp cord when pulsation stopped, usually between 2 and 3 minutes after birth and keep the baby between the mother's thighs level or below the placenta.
- Prevent hypothermia by nursing skin to skin.
- Initiate early breastfeeding.
- Minimise infection by hand washing, cord care and using clean materials.
- Give an injection of vitamin K.

Section 45: Care of the newborn and neonatal resuscitation

Most babies do not need any resuscitation at birth but only require basic care to prevent infection and hypothermia. Extensive mouth suction, facemask oxygen, and vigorous stimulation in order to provoke a first gasp or cry are unnecessary rituals without clinical justification. As long as the baby becomes pink, and starts to breathe without distress, most babies should stay with their mothers and have a first feed at the breast within minutes of birth.

Colostrum, the initial milk with a clear, yellowish and thick appearance, is an extremely nutritious and concentrated feed rich in immunoglobulins (it is only present during the first 3 to 4 days). Mothers should be informed of its benefits and that it is ideal for their baby to feed on this as soon after birth as possible and as frequently as possible.

Preventing heat loss after birth

- Once any necessary resuscitation process has finished and as soon as the baby becomes pink, and starts to breathe without distress, give to the mother for skin-to-skin contact and the first feed at the breast. This not only prevents hypothermia but also helps better uterine contraction following delivery.
- The practice of using water or oil to clean the skin within a few hours of birth before the body temperature has stabilised can make the baby dangerously hypothermic. A simple drying of the skin with a warm towel or sheet is all that is required.
- The mother's own body is the most effective source of warmth, so long as the baby is first well dried to minimise evaporative heat loss. A larger sheet or blanket can then be used to protect both mother and baby from the convective heat loss caused by draughts.
- Babies have relatively large heads. Covering the head with a shawl, blanket or woollen cap can reduce heat loss.
- Heat and water loss through the skin can be a particular problem in babies born before 32 weeks' gestation. This can be limited initially by wrapping all but the face in a clean plastic wrapping such as cling film or a food- grade plastic bag with a hole cut in the end of the bag for the baby's head to protrude, for a few hours after birth. Remember that plastic over the face can cause death from suffocation. If plastic bags or cling film are not available, the preterm baby must be wrapped well in a clean towel or blanket. However, plastic bags are very good for preventing heat loss, but only in conjunction with an overhead heat source or heated mattress. If the fluid in the bag gets cold it will cool the baby quicker than drying and wrapping.
- Heat supplementation can be provided by locally built and maintained incubators, overhead heating systems, but most effectively in low resource settings by skin-to-skin (kangaroo) care.
- The first bath must be delayed for at least 24 hours.

Managing the placenta, cord and umbilical stump

Babies often become relatively anaemic 4 to 6 months after birth because red cell production does not keep pace with body growth. This problem can be minimised by ensuring that blood intended for the baby is not left in the placenta at birth.

If the baby is held higher than the placenta (i.e. on the mother's abdomen) while the cord is still pulsating, blood will drain out of the baby and into the placenta, so hold the (covered) baby just below the placenta for 2 minutes if the cord is still pulsating. If the cord is clamped before it stops pulsating, this will also reduce the normal 'placental transfusion' at birth, especially if the uterus has not yet contracted. If, however, blood is artificially 'milked' from the placenta into the baby, it is possible to leave the baby with so many red cells that the blood becomes thick and

Section 45: Care of the newborn and neonatal resuscitation

polycythaemic. Neonatal polycythaemia has many complications, including putting the circulation under strain, making the capillary circulation very sluggish, and increasing the risk of jaundice.

The cord must be cut cleanly, and the cut stump secured in a manner that minimises the risk of late haemorrhage.

The umbilical stump will shrink as it dries out. Plastic clamps that shut down further as the cord starts to shrink are very effective. They are relatively inexpensive, and they do make it possible to cut the stump about 2–4 cm from the skin. An elastic band, if carefully applied, is a cheap and well-tested alternative. A stump that is left too long provides a reservoir where bacteria can breed and multiply with great speed, and therefore should **not be permitted**. A length of 2–4 cm is ideal.

Recent studies in resource-limited countries have shown that the application of 4% chlorhexidine solution immediately after birth can prevent omphalitis. Other possible antiseptics include surgical spirit or iodine.

Often the cord manifests a little 'stickiness', which may be of no concern. However, a local antiseptic should be applied if a red skin flare suggests early spreading staphylococcal cellulitis. Such babies **must also be given** an oral anti-staphylococcal antibiotic (cloxacillin or flucloxacillin). If the skin around the stump becomes oedematous with increasing redness, IV cloxacillin or oral flucloxacillin (25 mg/kg three times a day for 7 days) must be given. Babies who are systemically unwell always need urgent broad-spectrum antibiotic treatment, IV or IM, for septicæmia.

Ensuring that all mothers receive at least two injections of tetanus toxoid 1 month apart during pregnancy can eliminate the risk of neonatal tetanus.

The risk of cross-infection during or after birth

The WHO estimates that infection is responsible for one-third of all neonatal deaths (over 3000 deaths a day). Kangaroo mother care has significantly reduced the number of neonatal deaths from infection by colonising babies with the mother's bacteria rather than those of the hospital.

Perform neonatal examination before discharge of all babies

If not already given, ensure that vitamin K 1 mg IM is administered

Resuscitation of the newborn Infant

Most infants breathe well and do not need active 'resuscitation' at birth. Simply drying the infant with a warm dry sheet/towel will in most cases stimulate a cry from the infant thus expanding the lungs. Attempts to clear the airway, to stimulate breathing, or to give facial oxygen are unnecessary. Therefore routine airway suctioning is not needed.

Around 5% of infants do not breathe spontaneously after delivery. However, breathing can be started in almost all these infants by correctly applying bag-and-mask ventilation. With lung inflation there is an immediate and easily detectable rise in heart rate. It may be difficult to identify the infant's pulse rate by palpation at any site, so the best way to determine the heart rate is to listen over the chest with **a stethoscope**.

Far less commonly, infants are born cyanosed, shocked, limp and hypotonic. Around 1% do not respond to bag- and-mask ventilation, and need further help with advanced resuscitation.

Section 45: Care of the newborn and neonatal resuscitation

Guidelines from the 2010 International Liaison Committee on Resuscitation

(*ILCOR*) The main changes that have been made to the Neonatal Life Support (NLS) guidelines relevant to resource-limited countries are as follows:

- The use of food-grade plastic wrapping (cling film) is recommended to maintain body temperature in very small preterm infants.
- Ventilatory resuscitation may be started with air. However, where possible, additional oxygen should be available if there is no rapid improvement in the infant's condition.
- Adrenaline should be given by the IV route, as standard doses are likely to be ineffective if given via a tracheal tube.
- If there are no signs of life after 20 minutes of continuous and adequate resuscitation efforts, discontinuation of resuscitation may be justified.

First call for help

Start the clock or note the time. Keep the infant dry and warm and assess their breathing and heart rate.

- Infants are born small and wet. They get cold very easily, especially if they remain wet and in a draught. Whatever the problem, **dry the infant well, including the head**. Remove the wet towel, and wrap the infant in a dry towel. It is helpful if the towels are warm.
- There is good evidence that for very preterm infants (30 weeks' gestation or earlier), placing the infant under a radiant heater after drying, and immediately covering the head and body, apart from the face, with clean plastic wrapping, is the most effective way of keeping these very small infants warm during resuscitation.
- Drying the infant immediately after delivery will provide significant stimulation during which colour, tone, breathing and heart rate can continue to be assessed.
- Observing the breathing, skin colour, heart rate and tone helps to document the infant's condition and assess their response to resuscitation.
- Reassess these observations regularly (particularly the heart rate), every 30 seconds or so, throughout the resuscitation process. The first sign of any improvement in the bradycardic infant will be an increase in heart rate.
- A healthy infant may be born blue but will have good tone, will cry within a few seconds of delivery, will have a good heart rate (the heart rate of a healthy new-born infant is about 120–150 beats/minute) and will rapidly become pink during the first 90 seconds or so. An ill infant will be born pale and floppy, not breathing, and with a slow (<100) or very slow (<60) heart rate.
- The heart rate of an infant is best judged by listening to the chest with a stethoscope. It can also sometimes be felt by palpating the base of the umbilical cord, but a slow rate at the cord is not always indicative of a truly slow heart rate, and, if the infant is not breathing, must not delay the immediate application of lung inflations. In addition, if the infant is not breathing, feeling for peripheral pulses is potentially harmful as it delays the onset of life-saving lung inflations. If a stethoscope is not available, you can listen to the heart by placing your ear on the infant's chest or using a Pinard's stethoscope.

Airway: open the airway and keep it open

- Before the infant can breathe effectively the airway must be open.
- The best way to achieve this in an infant who is not breathing well is to place the infant on their back with the head in the neutral position (i.e. with the neck neither flexed nor extended). Most newborn infants will have a relatively prominent occiput, which will tend to flex the neck if the infant is placed on their back on a flat surface. This can be avoided by placing some support using a folded nappy or cloth under the shoulders of the infant, but be careful not to overextend the neck.
- If the infant is floppy it may also be necessary to apply chin lift or jaw thrust. The best way to stabilise an infant's condition at birth is to ensure that the upper airway remains unobstructed. The child will then have little difficulty in drawing air into the lungs when it takes its first spontaneous gasp or cry. Unfortunately, books often talk of the need to keep the airway 'clear', giving the false impression that the infant is going to find it difficult to breathe unless all the fluid and mucus is first sucked out of the way. There is no evidence that this is ever necessary unless the infant is meconium stained or does not breathe well. Moreover, blind deep suction of the nose or mouth can stimulate the vagus nerve, leading to bradycardia, apnoea and laryngospasm.

However, the upper airway of any infant who is born limp and hypotonic certainly needs to be opened and maintained in just the same way as the airway of any other unconscious patient. In an unconscious patient, pharyngeal tone decreases even more than it does during sleep, causing the upper airway to narrow or close. When such a patient is laid on their back the tongue also falls back, further obstructing the airway. There are three key ways to counter this:

- 1 Hold the head in the neutral position and
- 2 Support the chin or
- 3 Push the jaw forward.

Figure 45.1 Neutral position of the head and neck in a new-born infant

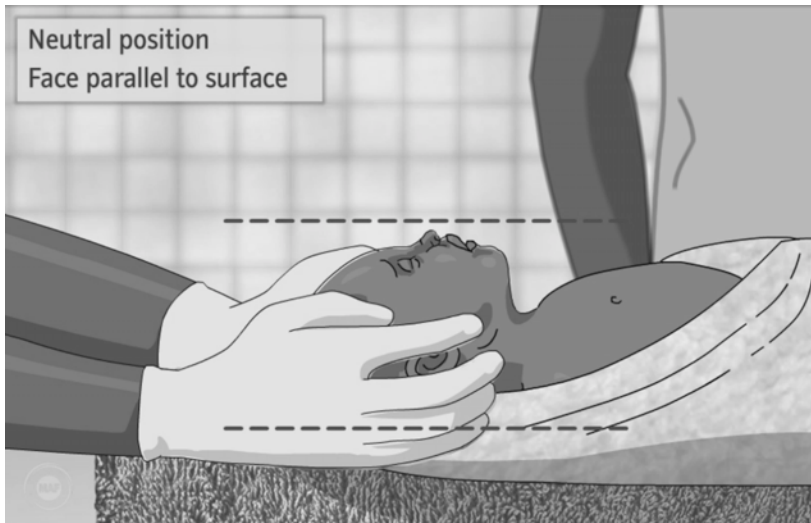

Section 45: Care of the newborn and neonatal resuscitation

Figure 45.2 Chin lift in a newborn infant



If tone is poor it may also be necessary to support the chin. It is important to support the bony part of the chin. Pressure anywhere else may merely push the base of the tongue backwards, making matters worse.

Figure 45.3 Jaw thrust in a newborn infant. Note that the operator's thumbs are in a position to hold a mask in place.



If tone is very poor it may be necessary to use one or two fingers under each side of the lower jaw, at its angle, in order to push the jaw forwards and outwards ('jaw thrust'), but this will require a second person to give the inflation and ventilation breaths with the bag-valve-mask.

Although it is rare for debris to completely block the trachea, this should be suspected if an infant tries to breathe but remains cyanosed and bradycardic, with laboured breathing and marked inter-costal and/or sternal recession. This is one of the few situations where tracheal intubation can be life saving.

Section 45: Care of the newborn and neonatal resuscitation

How to manage meconium

Around 15% of infants have meconium-stained liquor at birth. Meconium aspiration syndrome (MAS) can occur in about 1 in 10 such infants. The development of MAS is not entirely dependent on suctioning at birth. It is possible for infants to aspirate meconium into the large airways in utero if there is hypoxia and gasping. However, some infants may aspirate meconium during delivery, and these are the ones in whom the risk of MAS can be reduced by suctioning when the infant's head is on the perineum.

Studies based on experience from Africa and India have shown that suctioning the mouth of infants with meconium-stained liquor during birth when the head is at the perineum has dramatically reduced the incidence of meconium aspiration syndrome (MAS) and death. There is subsequently no need for further suctioning after birth if the infant breathes well.

What to do if the trachea appears to be blocked

If the infant is born through meconium and is unresponsive at birth, the oropharynx should be inspected and cleared of meconium. If intubation skills are available, the larynx and trachea should also be cleared under direct vision.

If meconium has entered the trachea, resuscitation here is only possible if the accumulated debris can be immediately removed. The easiest way to do this is to pass an endotracheal tube and then remove the debris by direct suction to the endotracheal tube. Sometimes the meconium debris is so large that it cannot be sucked through the tube. The tube can then be removed and replaced with a clean tube to clear the remaining obstructive material. Suction may also make it easier to see the larynx during intubation.

Giving mask ventilation for the infant who is not breathing before the meconium has been cleared (as above) may force the meconium deeper into the lungs.

Breathing

- If the infant is not breathing adequately give **five inflation breaths** as soon as possible. Until now the infant's lungs will have been filled with fluid. Aeration of the lungs in these circumstances is best with slow inflations at pressures of about 30 cmH₂O with the bag and mask; these are called 'inflation breaths'. These initial ventilation breaths should last 2–3 seconds each. The aim is to mimic the initial breaths taken by a normal infant to open the airways, remove lung fluid and achieve its functional residual capacity.

If the baby is very preterm, such inflation breaths may injure immature lungs: give lower pressure ventilation breaths (see below) in this situation.

- If the heart rate was below 100 beats/minute initially then it should rapidly increase as oxygenated blood reaches the heart. If the heart rate does increase then you can assume that you have successfully aerated the lungs and there is adequate tissue oxygenation. If the heart rate increases but the infant does not start breathing, then continue to provide regular ventilation breaths at a rate of about 30–40 breaths/minute until the infant starts to breathe.

- The chest may not move during the first one or two breaths as fluid is displaced. Adequate ventilation is usually indicated by either a rapidly increasing heart rate or a heart rate that is maintained at more than 100 beats/minute. Therefore reassess the heart rate after delivery of the first five breaths. It is safe to assume that the chest has been inflated successfully if the heart rate improves. Once the chest has been seen to expand and the heart rate has increased, ventilation should be continued at a rate of 30–40 breaths/minute. Continue ventilatory support until regular breathing is established.

- If the heart rate does not increase following inflation breaths, then either you have not aerated the lungs or the infant needs more than lung aeration alone. By far the most likely

Section 45: Care of the newborn and neonatal resuscitation

possibility is that you have failed to aerate the lungs effectively. If the heart rate does not increase, and the chest does not passively move with each inflation breath, then you have not aerated the lungs.

Under these circumstances consider the following:

- Are the infant's head and neck in the neutral position?
- Do you need jaw thrust?
- Do you need a second person's help with the airway or to squeeze the bag? A relative or ward orderly can be shown immediately how to effectively squeeze the self-inflating bag while you ensure that the mask is held firmly and in the best position on the face over the mouth and nose with the airway open.
- Is there an obstruction in the oropharynx (laryngoscope and suction under direct vision)?

Bag-and-mask inflation of the lung

Having positioned the infant correctly it is usually easy to inflate the lungs using a self-inflating bag and mask.

Remember that the infant cannot breathe through the bag-valve-mask system, so do not leave the mask sealed to the face and expect the infant to breathe from the bag. The valve between the bag and the mask prevents this. When the infant is breathing, remove the mask and watch closely to ensure that adequate breathing continues.

Most infants will respond to bag-and-mask ventilation by gasping and then starting to breathe on their own without further support. If this does not happen, it is still easy to confirm that lung aeration has been achieved, because the heart rate will rise reliably and consistently above 100 beats/minute. If lung aeration has been achieved and the infant still has a slow heart rate, proceed to support the circulation (C). If oxygen is available, applying this through the bag and mask may also help.

Correct bag-and-mask ventilation is the single most important skill needed to provide active resuscitation.

There is good evidence that most infants can be resuscitated using mask resuscitation without any need for tracheal intubation. However, some infants require early intubation, so the equipment and the skill to intubate should be available.

Evidence suggests that air is safer for initial resuscitation. However, where possible additional oxygen should be available for use if there is not a rapid improvement in the infant's condition. Equally, hyperoxia should be avoided, especially in the preterm infant. If a pulse oximeter is available this can be done. Try to keep the SaO₂ between 88% and 95%.

When to cut and clamp the cord in an infant who needs resuscitation at birth

There are advantages to delaying clamping of the cord for 2 minutes after birth to allow placental transfer of blood to the infant (see above). However, it is important to ensure that by doing this there is no harm to the mother (e.g. if she needs resuscitation) or to the infant (e.g. if they require resuscitation). Usually the umbilical cord is clamped and cut immediately if the infant needs active resuscitation.

Mouth-to-mouth and nose resuscitation

Most current guidelines on neonatal care steer clear of discussing the role of mouth-to-mouth resuscitation. The risk of HIV infection or hepatitis has further fuelled that reluctance. However, there is no doubt that this can be an effective way of reviving an apparently lifeless infant in the absence of equipment. Remember the following:

- Keep the upper airway open by optimising the position of the head and jaw as described above.
- Cover the infant's nose and mouth with your mouth (or cover the mouth of a big infant and just pinch the nose).
- Use the pressure you can generate with your cheeks, and try to aerate the lung by slow inflations for 2–3 seconds.
- Only use as much air for each breath as you can keep in your cheeks (i.e. do not 'blow' air into the infant, but just small puffs).
- Watch for chest movement, and allow time for lung recoil.
- Once the chest starts to move, sustain what has been achieved with 20–25 artificial breaths/minute.

Checking progress before moving on

- If the heart rate has not risen to over 100 beats/minute after the five initial breaths or within 30 seconds of adequate ventilation, something is wrong. The most likely problem is that you have not successfully ventilated the infant. Never move on to deal with the issues covered under letter C of the resuscitation alphabet until you are quite sure you have achieved objectives A and B. To do so is quite futile. Chest compressions will never restore the circulation until the blood being massaged from the lung to the heart contains oxygen.
- Look to see whether the chest moves each time you apply mask pressure. Movement should not be difficult to see once the first few breaths have aerated the lungs. It is usually easier to judge success with your eyes than with a stethoscope. In a newborn, breath sounds can be heard when only the airway is being aerated, so are not a good way to judge ventilatory success.
- Check that the infant's head is well positioned. Check chin support and jaw thrust, and that the mask is correctly applied with no air leaks. Ask a second person to help you position the infant optimally and provide inflations by squeezing the bag while you hold the airway open and the mask in place.
- Few infants need support with their breathing once their lungs have been aerated. Most will gasp, cry or breathe just as soon as an attempt is made to get air into the lungs, and then continue breathing adequately. However, a few may benefit from further support if they do not start to breathe regularly, or only gasp occasionally. Some may have suffered severe hypoxia in utero, and a few may be drowsy because of drugs given to the mother during labour. Check that the heart rate remains normal (above 100 beats/minute) and that there is no central cyanosis (best judged by looking at the colour of the tongue).
Try to assess whether there is hypoxemia (cyanosis or SaO_2 less than 90% with a pulse oximeter), if the infant's breathing remains laboured and irregular or if the child's colour remains blue. Give oxygen then if it is available, preferably with SaO_2 monitoring. Hyaline membrane disease, meconium aspiration syndrome, pneumonia or transient tachypnoea of the newborn are most likely.

Other possibilities include:

- intra-partum pneumonia (common)
- diaphragmatic hernia
- pneumothorax
- pulmonary hypoplasia (possibly associated with a skeletal or renal abnormality)
- cyanotic congenital heart disease (although this usually takes a little time to appear)
- persistent fetal circulation.

Section 45: Care of the newborn and neonatal resuscitation

- If breathing requires continuous support it is important to try and reduce mask inflation pressures to little more than half of what was needed to aerate the lung in the first place. It is easy to over-ventilate an infant with healthy lungs and to wash out so much of the carbon dioxide that normally provides the main stimulus to breathing that all such activity stops for a while. There is evidence that sustained over-ventilation can reduce cerebral blood flow.

Endotracheal intubation

As discussed earlier, most infants who need resuscitation can be managed with bag-valve-mask intubation. However, occasionally endotracheal intubation is required, but someone skilled and practised in the technique must do this. It is most likely to be required for prolonged resuscitation, in meconium aspiration, and in preterm infants with surfactant deficiency. A straight-bladed laryngoscope is preferred, and tube sizes are around 3.5 mm for a term infant and 2.5 mm for a preterm infant. Sizes larger and smaller than these should be available.

Resuscitation of preterm infants

- Infants with surfactant deficiency may have difficulty in expanding their lungs, and in developing a normal functional residual capacity at birth.
- However, the preterm lung is quite a delicate structure with relatively little elastic support, and any use of undue pressure or excessive ventilation during resuscitation can damage the lungs.

While an inspiratory pressure of 30 cmH₂O may well be necessary to begin aerating the lungs at birth, the pressure should be reduced as rapidly as possible to a level that ensures that the chest is moving adequately. The key aim must be to conserve such surfactant as already exists by sustaining the lung's functional residual capacity (an objective best achieved by providing at least 5 cmH₂O of positive end-expiratory pressure (PEEP). Aim to achieve this consistently throughout transfer to the nursery. This can be achieved using nasal prongs (nasal PEEP), thus avoiding tracheal intubation altogether (see Textbook).

Circulation: chest compressions

- Most infants needing help at birth will respond to successful lung inflation with an increase in heart rate followed quickly by normal breathing. Chest compression should be started only when you are sure that the lungs are being aerated successfully.
- If the heart rate remains very slow (less than 60 beats/minute) or absent following 60 seconds of ventilation with good chest movements, start chest compressions.
- In infants, the most efficient method of delivering chest compressions is to grip the chest in both hands in such a way that the two thumbs can press on the lower third of the sternum, just below an imaginary line joining the nipples, with the fingers over the spine at the back. This can only be done if there is a second operator ventilating the lungs (see Figure 45.4).
- If you are alone, the two-thumb method is not possible, as ventilations also need to be provided. In this situation, use the first two fingers of one hand to depress the lower sternum, while the other hand holds the mask in place (Figure 45.5). Then move the hand from the sternum to squeeze the bag.
- Compress the chest quickly and firmly, reducing the antero-posterior diameter of the chest by about one-third.
- Because oxygenation is such an important part of neonatal resuscitation, the recommended ratio of compressions to inflations in newborn resuscitation is 3:1.

Section 45: Care of the newborn and neonatal resuscitation

- Chest compressions move oxygenated blood from the lungs back to the heart and out into the ascending aorta. From there the two coronary arteries will then quickly deliver oxygen to the failing anoxic heart muscle. It is important to allow enough time during the relaxation phase of each compression cycle for the heart to refill with blood, at the same time ensuring that the chest is inflating with each breath.

Figure 45.4 Two-thumb compression of the chest, with a second operator ventilating the lungs, here using a T-piece as an alternative to bag and mask.

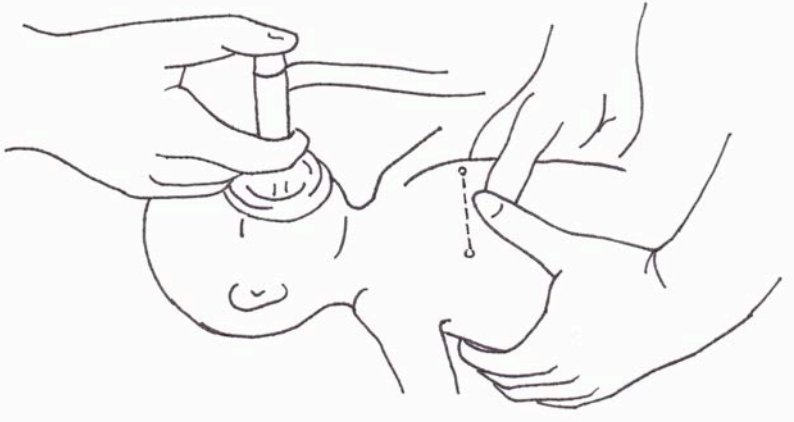

Figure 45.5 Two-finger chest compressions

- The rate of chest compressions is around 120/minute. However, with pauses for ventilation, the actual total number of compressions is less than 120/minute.

Drugs

Rarely inflation of the lungs and effective chest compression will not be sufficient to produce adequate circulation and perfusion in infants. In these circumstances, drugs may be helpful. However, drugs are needed only if there is no significant cardiac output despite effective lung inflation and chest compression.

Very few drugs have proved to be of benefit. The drugs used are adrenaline (1:10 000) and dextrose (10%). Drugs are best delivered via an umbilical venous catheter. In those where IV access is not possible, the intra-osseous route may be used. Each injection of a drug should be followed with a bolus of 2–3 mL of Ringer- lactate or Hartmann's solution. Unfortunately, most of the infants in whom cardiac output only returns after drug treatment require specialist neonatal care (often with mechanical ventilation) and do not survive to discharge. Most of those who do survive later develop profound disabling spastic quadriplegia.

Where the cause of the child's terminal apnoea is a sudden and much more abrupt hypoxic event (such as shoulder dystocia or an occasional case of late cord prolapse) these reservations may be less valid. Here there is at least anecdotal evidence that the outlook is much less bleak if the circulation can be restarted.

Acidosis not serious enough to precipitate circulatory standstill (asystole) will nearly always correct itself spontaneously within 90 minutes once the circulation has been restored and the infant starts to breathe for him- or herself. It does not therefore call for sodium bicarbonate, the use of which is controversial. Indeed, giving bicarbonate may increase carbon dioxide levels, worsening intracellular acidosis, and increases the amount of sodium that the potentially compromised kidney will need to excrete over the next few days.

- **Adrenaline:** The recommended dose of adrenaline is 10 micrograms/kg body weight (0.1 mL/kg body weight of 1:10 000 solution). If this is not effective, a dose of up to 30 micrograms/kg (0.3 mL/kg body weight of 1:10 000 solution) may be tried. Ideally, have ready-made and well-labelled 1:10 000 adrenaline solutions available on all emergency trolleys. In situations where this is not available in a ready-made state it could be prepared by adding 1 mL of 1:1000 solution to 9 mL of normal saline or Ringer-lactate or Hartmann's solution. It is potentially dangerous to leave inadequately labelled and made up doses of adrenaline around, as giving the same volume of 1:10000 as 1:1000 solution could cause cardiac arrest. Do not use a higher dose by these routes (IV) as it is harmful.
- **Glucose:** The recommended dose of glucose is 200 mg/ kg (2 mL/kg of 10% dextrose). Higher concentrations or larger doses can induce hyperglycaemia, which is associated with cerebral oedema and cerebral haemorrhage, and may lead to rebound hypoglycaemia. It is known that severe hypoglycaemia is rare immediately after birth, but tends to present after 1–2 hours.

However, hypoglycaemia (less than 2.5 mmol/litre (45 mg/dL)) is a potential problem for stressed or hypoxic neonates, so 10% dextrose should be considered in cardiac arrest, as the heart will not recover in the presence of hypoglycaemia. This should be followed by an infusion of 5 mL/kg/hour of 10% glucose if there is confirmation of hypoglycaemia by a blood test. This should be continued until feeding is well established. Never give any drug into the umbilical artery.

Section 45: Care of the newborn and neonatal resuscitation

- *Naloxone* (nalorphine) can be used to reverse profound opiate-induced respiratory depression, but has no real role in neonatal resuscitation. If it does prove necessary, it is best to give it intramuscularly and give a full 200-microgram 'depot' dose irrespective of body weight. If naloxone is given as a single dose IV it will be eliminated from the body faster than the opioid drug, causing a return of the respiratory depression, and therefore the infant may stop breathing again without a naloxone infusion. Naloxone does not reverse the respiratory depressing effects of non-opiate drugs.

Acute blood loss as a cause of circulatory arrest (circulatory volume support)

- Sudden acute blood loss is a rare, but often unrecognised, cause of acute circulatory collapse. Bleeding from an aberrant placental blood vessel (*vasa praevia*) or snapped umbilical cord can rapidly lead to hypovolaemic death. The response to a rapid generous infusion of any IV fluid can be equally dramatic. Speed is of the essence. Circulatory collapse probably does not occur until the infant has lost 30–40 mL/kg of blood, but 20 mL/kg of Ringer-lactate or Hartmann's solution will usually reverse the immediate critical hypovolaemia rapidly. The initial intravenous fluid bolus should be 10 mL/kg of Ringer-lactate or Hartmann's solution or blood group O Rh-negative blood (if immediately available). This can be repeated once if there is no or only minimal response. A packed red cell transfusion using group-specific or group O Rh-negative duly cross-matched blood can be given later to correct the associated anaemia.
- Other less well-recognised causes of hypovolaemic collapse include acute foeto-maternal blood loss, sudden twin-to-twin transfusion, and accidental incision of the placenta during Caesarean delivery and cord ligation that has come off and not been detected.

Apart from these specific indications, fluid should not be used during neonatal resuscitation. There is no evidence to suggest benefit from routine use, which only compounds the problem of fluid balance that can develop over the next 2 to 3 days if severe intra-partum stress causes secondary renal failure.

Poor response to resuscitation

If the infant either fails to respond or shows a poor response to resuscitation, the most likely problem is inadequate oxygenation. The following steps should be considered:

- Check the airway and ventilation.
- Check for technical faults if using equipment.
 - Is the oxygen attached?
 - Is the airway blocked?
 - Is the endotracheal tube in the correct place?
- Re-examine the chest to see if a pneumothorax has developed. This is not common, but may cause a problem. Drain a tension pneumothorax with a small cannula over needle (21 gauge) in the second intercostal space in the mid-clavicular line. This should be followed by the insertion of a chest drain (see Section 9).
- Consider the possibility of a congenital heart lesion if the infant remains cyanosed despite breathing and having a good heart rate.
- Consider the possibility of maternal opiates or sedation, such as diazepam or phenobarbitone, if the infant is pink, well perfused, but requires assisted ventilation.
- Shock, caused by acute blood loss, should respond to a rapid bolus of 10–20 mL/kg of O-negative blood (see above).

Section 45: Care of the newborn and neonatal resuscitation

- Consider the possibility of hypoglycaemia.

Stopping resuscitation

Even with the most effective resuscitation, not all infants will survive. If the infant has been without a cardiac output after 20 minutes of resuscitation and does not respond despite effective ventilations and chest compressions, the outcome is unlikely to be altered by the use of drugs, although these should be considered. The decision to stop resuscitation should be taken by the most senior healthcare worker present, and the reason for the decision should be clearly documented. Explain sensitively to the parents that the infant has died. The infant should then be handed in accordance with cultural preference and practice.

Figure 45.6 Algorithm for resuscitation of the baby at birth

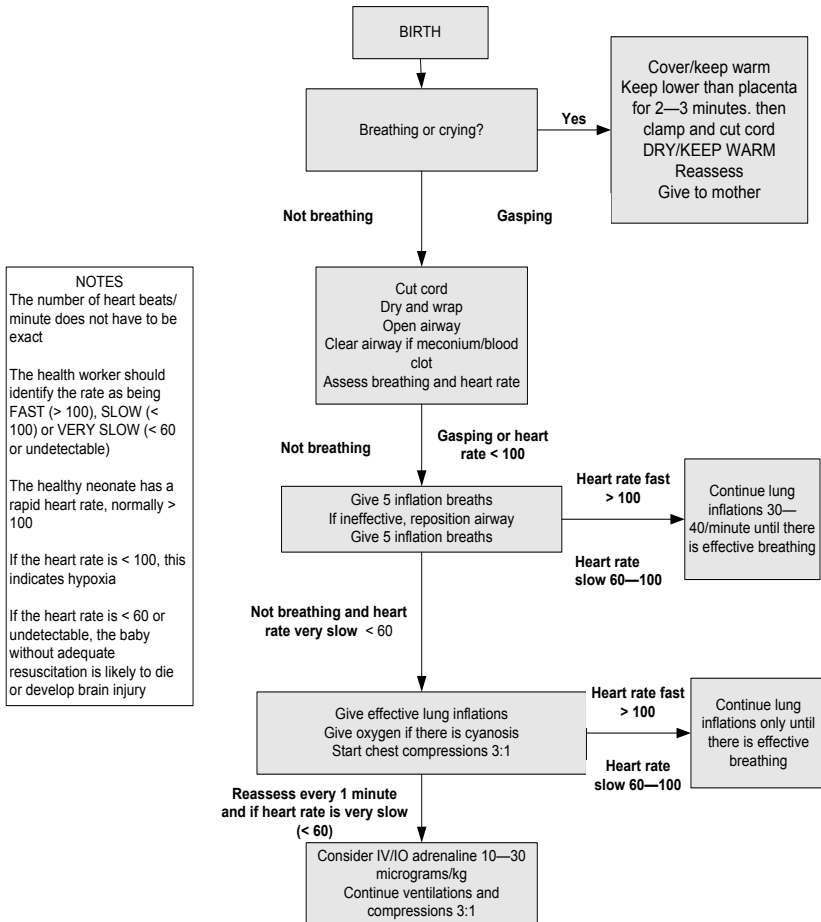

Vitamin K prophylaxis against haemorrhagic disease of the newborn

Following resuscitation/stabilisation, all newborn infants should receive vitamin K 1 mg IM. Vitamin K is given to prevent haemorrhagic disease of the newborn (HDN), which may cause significant bleeding and even death. The IM route is preferred as it provides a depot over many weeks. Similarly, neonates requiring surgery, those with birth trauma, preterm infants and those exposed in utero to maternal medication that is known to interfere with vitamin K are at especially high risk of bleeding and must be given vitamin K 1 mg IM. This is often forgotten in the rush to get the infant to the nursery.

Section 46: Appendix**Normal vital signs***TABLE 46.1 Normal vital signs by age in pregnant women and girls*

Age (years)	Heart rate	Systolic blood pressure	Respiratory rate
In pregnancy	70–110*	95–135	15–20

*Heart rate in pregnancy increases by 10–15 bpm.

WHO defines tachycardia as if > 110 bpm in pregnancy. Consider shock may be developing or present.

TABLE 46.2 Normal heart rates when awake and asleep

Age group	Heart rate when awake	Heart rate when asleep
10 years to adulthood	55–90	50–90

TABLE 46.3 Normal systolic and diastolic blood pressure

Age group	Systolic blood pressure (mmHg)	Diastolic blood pressure (mmHg)
In pregnancy	95–135*	60–85

*In pregnancy if systolic BP is < 90 mmHg consider shock may be present and if < 95 mmHg investigate for possible indicators of developing shock.

Do not base decisions to treat hypertension on the results of electronic sphygmomanometers, as they can be inaccurate. Always check with a hand-pumped machine.

Capillary refill time

The normal capillary refill time (CRT) is up to 3 seconds. It is important to be aware that in colder environments peripheral CRT is not a reliable test of perfusion.

Urine output

WHO recommendations are as follows:

Pregnant women: > 30 mL/hour or > 100 mL every 4 hours.

Normal core body temperatures

36.0–37.2°C (96.8 – 98.6°F).

To convert °C to °F multiply by 9, then divide by 5 then add 32.

Section 46: Appendix

To convert °F to °C deduct 32, then multiply by 5, then divide by 9.

Circulating blood volume

In pregnancy: 100 mL/kg.

Normal values for laboratory measurements

Haematology

TABLE 46.4 *Normal laboratory values for haemoglobin concentration*

Age	Haemoglobin concentration (grams/dL)
In pregnancy	12.0–16.0

TABLE 46.5 *Normal laboratory values for platelet count*

Age group	Platelet count ($\times 10^9$ /litre)
In pregnancy	150–400

TABLE 46.6 *Normal laboratory values for erythrocyte sedimentation rate (ESR), white blood cell count (WBC) and lymphocyte count*

	<i>ESR (mm/hour)</i>
Pregnancy	0–10
	<i>WBC ($\times 10^9$/litre)</i>
Pregnancy	4.5–11.0
	<i>Median lymphocyte count ($\times 10^9$/litre)</i>
Pregnancy	4.1–6.0

Chemistry

TABLE 46.7 *Chemistry: normal laboratory values*

Substance	Age	Normal range	
Albumin (grams/litre)	Adult	40–53	
Amylase (units/litre)	All ages	30–100	
Bicarbonate (mmol/litre)	All ages:		
	Arterial	21–28	
	Venous	22–29	
Bilirubin (conjugated)		0–3.4	
Calcium (mmol/litre)		2.15–2.70	(1.12–1.23 ionised)
Chloride (mmol/litre)		98–106	
Creatinine (μ mol/litre)		27–88	
Glucose (mmol/litre)		3.3–5.5	

Section 46: Appendix

Magnesium (mmol/litre)		0.60–0.95	
Osmolarity (mosmol/litre)		276–295 (serum)	
Potassium (mmol/litre)		3.5–5.5	
Sodium (mmol/litre)		135–145	
Urea (mmol/litre)		2.5–6.6	

Oxygen saturation (SpO₂)

The normal range is 95–100%, although oxygen saturation depends on altitude, and corrections will be needed for those living more than 1000 metres above sea level.

Table lists the oxygen saturation levels measured in studies conducted at a range of different geographical locations above sea level.

TABLE 46.8 SpO₂ levels measured at a range of different altitudes

Altitude	Locatio	No:	Age group	SpO ₂ (%)	Author(s)	Year of
Sea level	UK	70	2–16 years Mean 8 years	Range: 95.8–100 Median: 99.5	Poets <i>et al.</i>	1993
Sea level	Peru	189	2 months to 5 years	Range: 96–100 Mean: 98.7	Reuland <i>et al.</i>	1991
1610m	Colorado	150	<48 hours 3 months	95% CI: 88–97 Mean: 93 95% CI: 86–97 Mean: 92.2	Thilo <i>et al.</i>	1991
1670m	Nairobi	87	7 days to 3 years	Range: 89.3–99.3 Mean: 95.7	Onyango <i>et al.</i>	1993
2640m	Bogota	189	5 days to 2 years	Range: 84–100 Mean: 93.3	Lozano <i>et al.</i>	1992
2800m	Colorado	72	3–670 days	Range: 88–97 Mean: 91.7	Nicholas <i>et al.</i>	1993
3100m	Colorado	14	6 hours to 4 months 1 week 4 months	Range: 81–91 Mean: 80.6±5.3 Mean: 86.1±4.6	Niemeyer <i>et al.</i>	1993
3658m	Tibet*	15	6 hours to 4 months	Immigrant: 76–90 Indigenous: 86–94	Niemeyer <i>et al.</i>	1995
3750m	Peru	153	2–60 months	Range: 81–97 Mean: 88.9	Reuland <i>et al.</i>	1991

Values shown are those in quiet sleep.

*Ranges are values for those born to immigrant Chinese mothers and for those indigenous babies whose families have lived at that altitude for innumerable generations.

Blood gases (normal arterial range)

In pregnancy:

- pH: 7.40–7.46
- pCO₂: 3.7–4.2 kPa (28–32 mmHg)
- Standard bicarbonate: 18–21 mmol/L

Equivalent values for certain drugs used in an emergency

1 mg of prednisone or prednisolone is equivalent to 4 mg of hydrocortisone and 150 micrograms of dexamethasone or betamethasone.

Adrenaline (epinephrine) 1 in 1000 contains 1000 micrograms in 1 mL.

Adrenaline (epinephrine) 1 in 10 000 contains 100 micrograms in 1 mL.

Measurements of medical supplies

French gauge Fr = circumference of tube in mm.

Urinary catheters: in pregnancy from 14–16 Fr.

Nasogastric tubes: in pregnancy 16–20 Fr.

Fluid and electrolyte management

Normal requirements for fluid

The circulating blood volume in pregnancy is 100 mL/kg. Thus initial expansion of vascular volume in a state of shock can be achieved with relatively small volumes of fluid. However, this volume is only a fraction of that required to correct dehydration, as the fluid has been lost from all body compartments in this condition. Clinically, dehydration is not detectable until more than 3–5% of the total body fluid has been lost. It is important to remember that although fluid must be given quickly to correct loss of circulating fluid from the blood compartment (i.e. in shock, except in malnutrition) must be given carefully in dehydration (see Section 12).

Fluid requirement can be divided into four types:

1. for replacement of insensible losses (through sweating, respiration, gastrointestinal loss, etc.)
2. for replacement of essential urine output (the minimal urine output to allow excretion of the products of metabolism, etc.)
3. extra fluid to maintain a modest state of diuresis
4. fluid to replace abnormal losses (e.g. blood loss, severe diarrhoea, diabetic polyuria losses, etc.).

A useful formula for calculating normal fluid requirement is provided in Table 46.9. It is simple, can be applied to all age ranges and is easily subdivided. The formula gives total fluid requirements – that is, types (1), (2) and (3) listed above.

TABLE 46.9 Normal fluid requirements

Bodyweight	Volume of fluid	Volume of fluid	Na ⁺ (mmol/	K ⁺ (mmol/	Energy (kcal/ 24	Protein (grams/ 24
First 10kg	100	4	2.0–4.0	1.5–2.5	110	3
Second 10 kg	50	2	1.0–2.0	0.5–1.5	75	1
Subsequent kg	20	1	0.5–1.0	0.2–0.7	30	0.75

For example:

a pregnant woman weighing 60 kg would require 1000 + 500 + 800 = 2300 mL per day.

Section 46: Appendix

In practice, the healthy patient only drinks when they are thirsty, but it is useful to have an idea of how much fluid a patient should be expected to need. Of course, if there are excess losses, as in diarrhoea or fever, or if the ambient temperature is especially high, leading to high insensible losses, more fluid is required. Except in cardiac or renal disease, a good way to check whether a pregnant woman is taking in enough fluid is to see whether they have a satisfactory urine output of at least 30 mL/hour.

Average fluid requirements in pregnancy are 1500– 2500 mL/day. This depends on levels of activity, ambient temperature and whether or not the mother has a fever.

Rehydration

Fluid deficit + normal fluid requirements + ongoing losses (sweat, diarrhoea, vomit, etc.).

Fluid deficit (mL) = percentage dehydration × weight (kg) × 10.

Ongoing losses:

- After each loose stool: 100–500 mL
- After each vomit: 2 mL/kg body weight.

Some useful information about biochemical measurements

- 1 ounce = 28 mL
- Percentage solution = number of grams in 100 mL (e.g. 10% dextrose = 10 grams in 100 mL).
- One millimole = molecular weight in milligrams.

Useful figures to know:

- 30% NaCl = 5 mmol/mL each of Na⁺ and Cl⁻
- 0.9% NaCl = 0.154 mmol/mL each of Na⁺ and Cl⁻
- 15% KCl (15 grams/100 mL) = 2 mmol/mL each of K⁺ and Cl⁻ (also called concentrated or strong KCl)
- 10% calcium gluconate (10 grams/100 mL) = 0.225 mmol/mL (note that 1 mL of calcium chloride 10% is equivalent to 3 mL of calcium gluconate 10%)
- 8.4% NaHCO₃ = 1 mmol Na⁺ and 1 mmol HCO₃⁻ /mL

1 mL/hour of normal saline = 3.7 mmol Na⁺ in 24 hours.

Serum osmolarity = 2(Na⁺ + K⁺) + glucose + urea (normally 285–295 mosmol/litre).

Normal requirements for electrolytes (unless there are excessive losses)

There are obligatory losses of electrolytes in stools, urine and sweat, and these require replacement. Any excess is excreted in the urine.

TABLE 46.10 Electrolyte content of body fluids

Fluid	Na ⁺ (mmol/litre)	K ⁺ (mmol/litre)	Cl ⁻ (mmol/litre)	HCO ₃ ⁻ (mmol/litre)
Plasma	135–145	3.5–5.5	98–108	20–28
Gastric fluid	20–80	5–20	100–150	0
Intestinal fluid	100–140	5–15	90–130	13–65
Diarrhoea	7–96	34–150	17–164	0–75
Sweat	<40	6–15	<40	0–10

TABLE 46.11 Normal water and electrolyte requirements in pregnancy

Maintenance requirements/24	Volume of fluid (mL/day)	Sodium requirement (mmol/ day)	Potassium requirement
	1500–2500	150	100

Commonly available crystalloid and colloid fluids

TABLE 46.12 Commonly available crystalloid fluids

Fluid	Na ⁺ (mmol/litre)	K ⁺ (mmol/litre)	Cl ⁻ (mmol/litre)	Energy (kcal/
<i>Isotonic crystalloid fluids</i>				
Saline 0.9% (normal)	150	0	150	0
Glucose 5% (50 mg/mL)	0	0	0	200
Hartmann's solution or Ringer-lactate	131	5	111	0
<i>Hypertonic crystalloid fluids</i>				
Saline 0.45%, glucose 5%	75	0	75	200
Glucose 10% (100 mg/mL)	0	0	0	400
Glucose 50%	0	0	0	2000

*Hartmann's or Ringer-lactate solution also contains HCO₃⁻ as lactate 29 mmol/litre and calcium 2 mmol/litre.

To make 10% glucose/dextrose solution in Ringer-lactate/ Hartmann's or 0.9% saline, remove 100 mL from a 500 mL bag and inject into it in a sterile manner 100 mL of 50% dextrose/glucose.

To make 5% glucose/dextrose solution in Ringer- lactate/Hartmann's or 0.9% saline, remove 50 mL from a 500 mL bag and inject into it in a sterile manner 50 mL of 50% dextrose/glucose.

To make a 10% solution of glucose for injection in treating hypoglycaemia and if there is only 50% dextrose/ glucose solution available:

- either dilute 10 mL of the 50% solution in 40 mL of sterile water
- OR add 10 mL of 50% dextrose to 90 mL of 5% glucose which will give an approximate 10% glucose solution.

TABLE 46.13 Commonly available colloid fluids

Colloid	Na ⁺ (mmol/litre)	K ⁺ (mmol/litre)	Ca ²⁺ (mmol/litre)	Duration of action	Comments
Albumin 4.5%	150	1	0	6	Protein buffers
Gelofusine	154	< 1	< 1	3	Gelatine
Haemaccel	145	5	12.5	3	Gelatine
Pentastarch	154	0	0	7	Hydroxyethyl

Drop factor for IV infusions

Fluids can be calculated in drops/minute as follows. First identify from the IV giving set what the 'drop factor' is (for standard giving sets this may be 10, 15 or 20 drops = 1 mL). For micro-drop systems, which often accompany giving sets with burettes, 1 mL = 60 drops. When setting the infusion rate with the flow controller on the giving set below the chamber where the drops occur, always set and count the rate over a full minute.

Calculating drip rates for a standard giving set with a drop factor of 20 drops/mL

- One mL = 20 drops in standard giving set.
- Number of drops/minute = mL/hour with a standard giving set divided by 3.

With a micro-dropper infusion giving set with a drop factor of 60 drops/mL, 1 mL = 60 micro-drops.

Measuring neurological state

A = ALERT

V = responds to VOICE

P = responds to PAIN = Glasgow Coma Scale score of ≤ 8 .

U = UNRESPONSIVE

Hypoglycaemia: definition and blood glucose conversion

Hypoglycaemia is defined as a blood glucose concentration of < 2.5 mmol/litre or < 45 mg/dL.

1 mmol/litre = 19 mg/dL of glucose.

INDEX

INDEX

Abdominal pain in pregnancy	70-74
Abdominal paracentesis	272-274
Abdominal trauma	271-274
Abscess	62
Advanced Life Support	41-60
Airway	41
Amniotic fluid embolism	158
Anaemia in pregnancy	87-89
Anaphylaxis in pregnancy	197-198
Antepartum haemorrhage	100-108
Appendicitis in pregnancy	225
Appendix	306-312
Asthma in pregnancy	195-196
AVPU	5, 7, 29
Bag valve Mask	42-45
Basic Life Support	33-40
Bilateral pudendal nerve block	247-248
Blood glucose measure	29-31, 50, 199, 312
Blood pressure values	26-28, 125-129, 306
Blood transfusion	9-11, 262-263
Breathing	42
Breathing difficulties	79-80, 256-257
Breathing difficulties in child	295-299
Breech presentation	171, 177-180
Brow presentation	168, 174-175
Burns in pregnancy	277-284
Caesarian section	240-241
Cardiac arrest	33-39, 40
Cardiogenic shock	263
Catheter urine	107, 184, 230
Cervical tears. repair	244-245
Cervical spine immobilisation	254-255
Chest drain, insertion	258-259
Chest trauma	268-271
Chickenpox in pregnancy	227
Coma in pregnancy	205-209
Compound presentation	169, 176
Cord care	292-293
Cricothyrotomy	252-254
Cystitis in pregnancy	226
Defibrillation	58-60
Dehydration	212-217
Dengue	28
Destructive operations	242-243
Diabetes in pregnancy	199-204

INDEX

Eclampsia	125-140
Electrical injuries	281-282
Emergency obstetric procedures	230-248
Emergency symptoms, pregnancy	70-80
Empyema	210-211
Encephalitis in pregnancy	209
Epilepsy, pregnancy	128-130
Episiotomy	243-244
Exchange transfusion	28, 88, 194, 287
Face presentation	169, 175-176
Fetal distress during labour	160-161
Fluid administration	9, 49-58
Forceps delivery	237-240
Gastroenteritis in pregnancy	212-217
Haemorrhage, major obstetric	92-124
Haemorrhagic disease, newborn	305
Handwashing techniques	8
Head injury	267-268
Heart failure during pregnancy	193-194
Heart rates normal	25, 105, 112, 188, 306
Hyperemesis gravidarum	191-192
Hypertension	125-140
Hypoglycaemia neonate	291, 302-304
Infection control	8
Infection prevention birth	152-155, 290-291
Intraosseous needle	54-57
Inverted uterus	187-190
Limb trauma	276
Log roll	274-275
Long saphenous vein	58
Lumbar puncture	62-64
Major obstetric haemorrhage	92-124
Malaria in pregnancy	217-224
Mal-positions & mal-presentations	166-180
Managing emergencies	20-32
Manual removal placenta	245-247
Meningitis in pregnancy	209
Miscarriage	90-91, 94-100
Multiple births	162-165
Nasogastric tube	60-61
Nebuliser	47-48
Needle percardiocentesis	270-271

INDEX

Needle thoracocentesis	257-258
Neonatal breathing problem	295-299
Neonatal care	290-305
Neonatal sepsis	290-291
Neurogenic shock	263
Neurological failure	264
Normal vital signs	306
Obstructed labour	141-151
Occiput anterior positions	167-168
Occiput posterior positions	168, 171-174
Pain control	12-18, 265
Partogram	141-144
Pelvic trauma	275-276
Pericardiocentesis	270-271
Placenta, manual removal	245-247
Pleural effusion	210-211
Pneumonia child	299-300
Pneumonia in pregnancy	210-211
Poisoning in pregnancy	285-289
Post natal depressive illness	228-229
Post operative care	241
Post partum haemorrhage	109-124
Pre-eclampsia	125-131
Preterm birth	181-183, 290
Prolapsed cord	184-186
Pudendal nerve block	247-248
Prolonged labour	141-151
Pulmonary embolism	156-157
Pulse oximetry	47
Pyelonephritis in pregnancy	226
Rectal drugs	16, 49
Reduced fetal movements	159
Renal failure	136, 222
Respiratory rate normal	23, 105, 112, 306
Resuscitation	20-32
Resuscitation newborn	293-305
Retained placenta	119-121
Ruptured ectopic pregnancy	91-94
Ruptured uterus	103-104, 146-147
Sepsis in pregnancy	152-155
Septic abortion	90-91
Septicaemia child	293
Shock child	304
Shock pregnancy	81-86
Shoulder dystocia	147-151
Skills needed, emergency	41-64

INDEX

Spacers and nebulisers	47-48
Spinal trauma	274
Status epilepsy pregnancy	128-130
Structured approach to emergencies	20-32
Surgical airway	22, 252-254
Symphysiotomy	237, 241-242
Symptoms, pregnancy emergencies	70-80
Tetanus neonate	293
Transport ill patients	19
Transverse lie	170, 176-177
Trauma in pregnancy	249-277
Triage	5-7
Twins	162-165, 237, 303
Umbilical vein catheter	302
Upper airway obstruction	21-22, 252
Urethral catheterisation	230
Uterine inversion	119, 246
Vaginal bleeding	75-79
Varicella zoster in pregnancy	227
Ventouse	230-237
WHO Safe Childbirth checklist	65-69
Xray in trauma	266-267, 269, 275, 276